

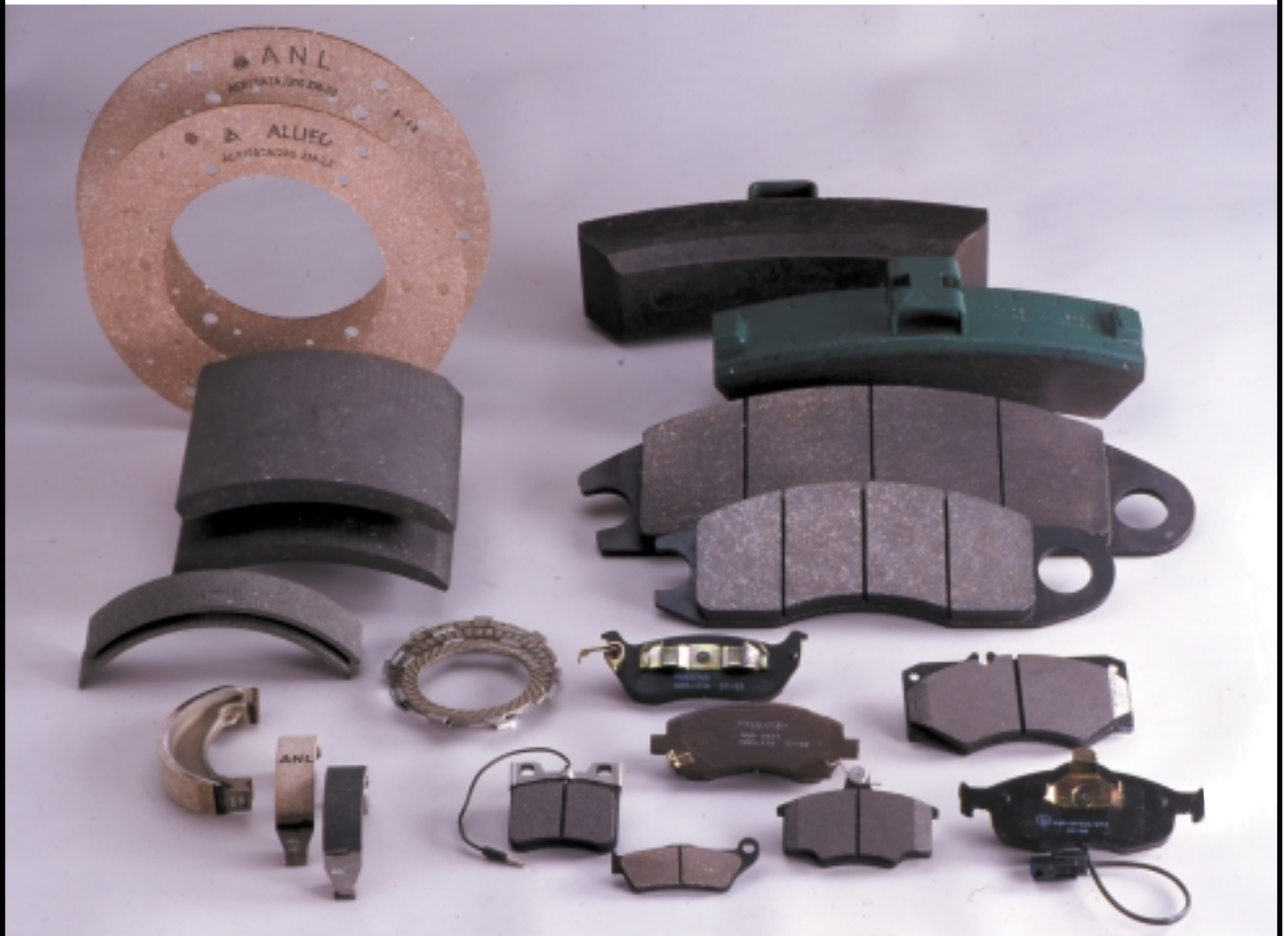

# Contents

ANL  
Braking

Translations and Abbreviations	ii
General Terms and Conditions of Sale	iii
The Company	iv - viii
Disc Brake Pads Numerical List	1 - 8
Disc Brake Pads Application Data	9 - 140
Disc Brake Pads Illustrations	141 - 214
Wear Lead Illustrations	215 - 224
Fitting Kit Illustrations	225 - 232
Interchange References	233 - 257
Summary at a Glance	
Interchange References by Manufacturer	





# Translations and Abbreviations

**ANL  
Braking**

ENGLISH	DEUTSCH	ESPANOL	FRANCAIS	ITALIANO
front	vorne	delantero	avant	anteriore
rear	hinten	trasero	arriere	posteriore
original equipment	oe nummern	referencias del fabricante	equipement d'origine	codice di primo equipaggiamento
solid disc	festen scheibe	disco no ventilado	disque non ventilee	disco no ventilato
vented disc	beluftenen scheinbe	disco ventilado	disque ventilee	disco ventilato
diameter	durchmesser	diametro	diametre	diametro
date	baujahr	fecha	date	date
WVA type number	WVA nummer		numero WVA	
anti-lock braking system	antiblockiersystem	sistema antibloqueo	systeme anti-blocage	sistema antibloccaggio
anti-skid regulator (traction control)	antriebes-schlupfregelung	sistemas antiderrapaje	systeme anti-patinage	sistema antislittamento
automatic transmission	automatischer getriebe	cambio automatico	b v automatique	cambio automatico
cylinders	zylinder	cilindro	cylindre	cilindro
diameter	durchmesser	diametro	diametre	diametro
double wear lead	doppelverschleissanzeige		fils temoins d'usure doubles	
estate	wagon / kombi	break	break	famigliare
excluding	ohne	sin	sans	escluso
front wheel drive	frontantrieb	traccion delantera	traction avant	trazione anteriore
including	mit	con	avec	con
injection	einspritzer	inyeccion	injection	iniezione
left hand drive	linkslenker			
long wheel base	langer radstand	distancia entre ejes larga	epatement long	passo lungo
manual transmission	handschaltgetriebe	caja de cambios manual	b v manuel	
multi-link axle	multi-link achse	eje multi-link	essieu multi-link	sospensione multi-link
notes	bemerkungen	notas	observations	note
no wear lead			sans fils temoins d'usures	
quantity			quantite	
right hand drive	rechtslenker			
rear wheel drive	heckantrieb	traccion trasera	traction arriere	trazione posteriore
saloon	berline	berlina	berline	berlina
standard	normale	estandard	standard	
short wheel base	kurzer radstand	distancia entre ejes corta	epatement court	passo corto
van	lieferwagen	furgoneta	fourgonnette	furgonato
vehicle identification number	fahzeug-identifications-nummer	numero de identificacion del vehiculo	type	numero d'identificazione veicolo
wear lead	verschleissanzeige	indicador de desgaste	fils temoins d'usure	segnalatore
2 wheel steering			2 roues directrices	
2 wheel drive	2 rad antrieb	traccion a las 2 ruedas	2 roues motrices	duo ruote motrici
4 wheel steering			4 roues directrices	
4 wheel drive	allradantrieb	traccion a las 4 ruedas	4 roues motrices	quattro ruote motrici

## Abbreviations and Terms Used

F	FRONT	MAN	MANUAL
R	REAR	NWL	NO WEAR LEAD
ABS	ANTI-LOCKING BRAKING SYSTEM	O.E.	ORIGINAL EQUIPMENT
ASR	ANTI-SKID REGULATOR (TRACTION CONTROL)	QTY	QUANTITY
AUTO	AUTOMATIC	RWD	REAR WHEEL DRIVE
CYL	CYLINDERS	S	SOLID DISC
DIA	DIAMETER	STD	STANDARD
DWL	DOUBLE WEAR LEAD	SWB	SHORT WHEEL BASE
EXC	EXCLUDING	V	VENTED DISC
FWD	FRONT WHEEL DRIVE	V.I.N.	VEHICLE IDENTIFICATION NUMBER
INC	INCLUDING	WL	WEAR LEAD
INJ	INJECTION	2WS	2 WHEEL STEERING
LWB	LONG WHEEL BASE	2x4	2 WHEEL DRIVE
		4WS	4 WHEEL STEERING
		4x4	4 WHEEL DRIVE



# General Terms and Conditions of Sale

ANL  
Braking

- 1. Product Description**  
Automotive Components - Disc Brake Pads in Asbestos Free Composition.
- 2. Price**  
FOB, C&F or CIF in US Dollars or Stg. Pounds or any other mutually agreed currency.
- 3. Lead Time**
  - i) Ex-factory : 6–8 weeks from the date of acceptance of order.
  - ii) Ex London warehouse : Immediate, depending on availability of stocks.
- 4. Product Liability Insurance**  
Allied Nippon Friction Material Products are backed by worldwide product liability cover.
- 5. Brake Pad Illustrations**  
Drawings shown in the catalogue are not to full scale, but representative indication only.
- 6. Part Number Identification**

## Light CV Pads

ADB 3 163

- Disc brake pad part no.
- Type of wear indicator used e.g.
  - '0' denotes Disc brake pad without Wear Indicator
  - '1' denotes Disc brake pad with fixed Wear Indicator (Wire Sensor)
  - '2' denotes Disc brake pad with loose Wear Indicator (Wire Sensor)
  - '3' denotes Disc brake pad with Wear Indicator Spring Clip type.
  - '4' denotes Disc brake pad with Wear Indicator Plug type.
- Manufacturer's prefix to Disc brake pad part no.

## Heavy truck and trailer pads

ACV 001 P K

- 'K' denotes pad set with fitting kit (otherwise fitting kit not included)
- 'P' denotes premium / long life material (otherwise standard material)
- Disc brake pad part no.
- Manufacturer's prefix to disc brake pad part no.

## Important Points

1. Since car manufacturers have the right to modify without notice the names and characteristics of their products, Allied Nippon cannot, in any event, be held responsible for the accuracy of the information contained in this catalogue.  
Every effort has been made to ensure that information contained in this catalogue is accurate and easily understood. However, Allied Nippon cannot accept any liability for errors, omissions and losses arising from them. Other manufacturers name and part numbers are used for reference purpose only and their use does not imply any connection with Allied Nippon product.
2. The translation or reproduction, even partial, of material in this catalogue, as well as the use of the part codification system, is forbidden without the prior written authorization of Allied Nippon.
3. Allied Nippon wish to draw your attention to the fact that while some of our brake pads can appear to be interchangeable they, in fact, have different technical characteristics. Allied Nippon ask you, as a result, not to modify components nor to force their assembly if there are problems but to consult our Engineering Development Department for advice.  
We disclaim responsibility in case of incorrect use or defective assembly or if our Engineering Development Department has not confirmed the reference and applications indicated.
4. References in this catalogue are for identification only. Parts shall be supplied as per Allied Nippon standard product at the time of ordering.



Above logo represents Allied Nippon products, Unauthorised use is not permissible and for any violation, the company will take legal action.



## The Company

ANL  
Braking

ALLIED NIPPON, a QS9000/TS16949 Company, Manufactures disc brake pads in joint venture with Japan Brake Industrial Co. Ltd., Tokyo, Japan. The production of Friction Materials is based on absorption of technology, in-house product development and testing facilities, with a range of formulations to suit different performance requirements.

### **Japanese Joint Venture**

Japan Brake Industrial Co. Ltd. belonging to Hitachi Group is a major supplier to the world's leading automobile manufacturers including Honda, Suzuki, Mazda, Fuji, Nissan, Yamaha, Kawasaki, Hyundai, General Motors, Ford and Chrysler among others.





## **ECE Regulation 90**

ALLIED NIPPON brings to you the best of both Japanese and European technology. ECE R90 E-mark certified brake pads with performance characteristics that conform to within  $\pm 15\%$  of the OE performance specifications are now available for a wide range of passenger cars and LCV's on European roads.

## **R & D Quality Assurance**

ALLIED NIPPON friction materials pass through systematically defined Quality Assurance testing procedures and programmes — a rigorous selection process for incoming raw materials, zero defects in processing systems and quality control checks at every stage.

ALLIED NIPPON R&D challenges excellence everyday to improve material composition with on going research in its quest for better materials and consequently better products.





## Manufacturing & Technology

ALLIED NIPPON disc brake pads are manufactured with technology that is regularly upgraded to suit manufacturing and process requirements compatible with performance standards of friction materials worldwide. The production and processing are monitored by experienced and skilled personnel.

Several formulations in asbestos free (both organic and inorganic-semi-metallic) are available for manufacturing friction materials. ALLIED NIPPON is now progressively concentrating on manufacturing eco-friendly asbestos free friction materials compatible with world standards.

Allied Nippon disc brake pads are tested under ECE R-90 Regulation by TÜV, Germany, IDIADA Spain and VCA UK, and are being approved for E-mark — the mark of safety and guarantee of consistent quality.

ALLIED NIPPON friction material products are designed for and consistently guarantee complete safety, strength, high endurance, dependable and cost effective performance — backed by worldwide product liability cover.

As an OEM supplier of friction materials, ALLIED NIPPON continually invests in product development and research activities for application specific material formulations.

ALLIED NIPPON is a major supplier to brake system and vehicle manufacturers.

Both tooling and back plate design and manufacture are carried out in-house using state of the art software and machinery. Allied Nippon consistently meets the stringent requirements for the development of new market components demanded by its international customer base.







## Rapid Bedding Strips

In common with many original equipment pads, ANL trailer pads are supplied with a rapid bedding compound on the friction surface. These strips of specially formulated compound are effective immediately after pad fitment and continue to be effective until the pads are bedded in. This feature offers many advantages to the operator including:

- Rapid bedding of the pads to the disc surface, even where the disc is worn.
- Enhanced initial brake effectiveness without first having to bed pads in over tens or hundreds of miles.
- A light scouring action on the disc during the first few stops helps remove rust and / or other deposits.

All ANL trailer pads are supplied with rapid bedding compound as standard.

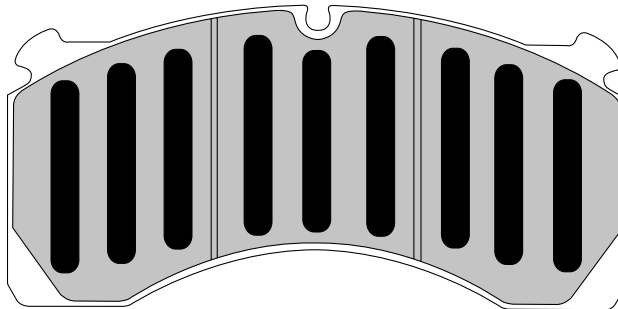

ACV047, the DX195 type trailer pad showing the rapid bedding strips.



## The Company

**ANL  
Braking**

The Quality Management System of  
**ALLIED NIPPON LIMITED**  
has been assessed and approved against the following quality  
assurance management systems standards

ISO/TS16949 : 2002

QS 9000 : 1998

in accordance with the requirements of  
QS 9000 Appendix B, Code of Practice  
and the requirements of  
ISO 9002 : 1994

The Quality Management System is applicable to  
Manufacture and Supply of Friction Products  
including Brake Linings, Bonded Brake Shoes,  
Clutch Facings, Clutch Plates and Disc Brake Pads for  
Automotive and Industrial applications

**ALLIED NIPPON LIMITED**  
is also approved against the international  
environmental standard EN14001  
as part of its commitment to  
low environmental impact production







## Vehicle Applications

SECTION

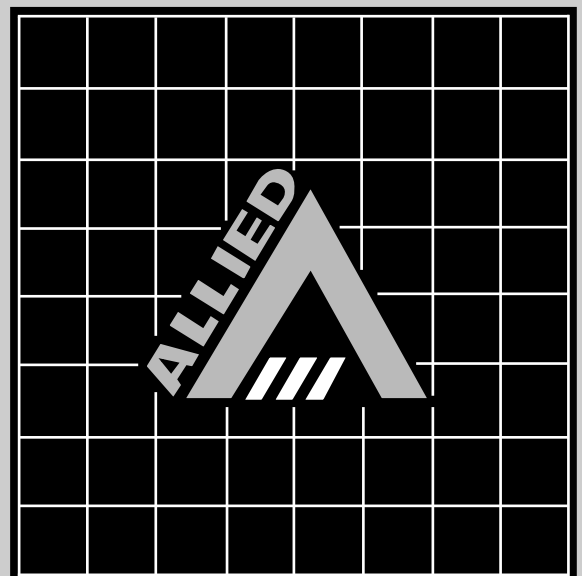



# Disc Brake Pads Vehicle Applications

**ANL**  
**Braking**

PART NUMBER	VEHICLE APPLICATION
ACV001	DAEWOO, DAF, IVECO
ACV002	AUWARTER, MERCEDES, OPTARE
ACV003	DAEWOO, DAF, IVECO
ACV004	AWD, IVECO, NISSAN, OPTARE, VOLVO
ACV005	RENAULT
ACV006	AUWARTER, DAF, KASSBOHRER, KNORR - BREMSSEN, MAN, MOSELEY / BOVA, VAN HOOL
ACV007	AWD, IVECO, NISSAN, OPTARE
ACV008	MENARINI, RENAULT
ACV009	DENNIS, RENAULT
ACV010	NISSAN, VOLVO
ACV011	IVECO, RENAULT
ACV012	KASSBOHRER, KNORR - BREMSSEN
ACV013	RENAULT
ACV014	AUWARTER, DENNIS, ERF, HEULIEZ, KAROSA, KASSBOHRER, MAN, MERCEDES, MERITOR, RENAULT, TRAILERS, VAN HOOL
ACV015	DENNIS, RENAULT
ACV016	IVECO
ACV017	IVECO
ACV018	IVECO
ACV020	IVECO
ACV021	IVECO, RENAULT
ACV022	IVECO
ACV023	IVECO
ACV025	AUWARTER, MAN
ACV027	DAF
ACV028	RENAULT
ACV029	DENNIS, HEULIEZ, MERITOR, RENAULT, TRAILERS, VOLVO
ACV030	AUWARTER, DENNIS, ERF, HEULIEZ, KAROSA, KASSBOHRER, MAN, MERCEDES, MERITOR, RENAULT, VAN HOOL
ACV032	IVECO
ACV033	MERITOR, NISSAN, RENAULT, TRAILERS, VAN HOOL
ACV036	AUWARTER, DAF, MAN, MERCEDES
ACV037	AUWARTER, MAN, MERCEDES
ACV038	DISCOS, GRANNING LYNX, KNORR - BREMSSEN, MERCEDES, SAE DUPILLIER, TRAILERS
ACV039	DAF, IVECO, MAN, OPTARE, RENAULT
ACV040	DAF, IVECO, MAN, RENAULT
ACV041	AUWARTER, DAF, DENNIS, IVECO, KAROSA, KASSBOHRER, KNORR - BREMSSEN, LIAZ, MERCEDES, SCANIA
ACV042	BPW AXLES, DISCOS, FRUEHAUF, GRANNING LYNX, HENDRICKSON, LECINENA, MERCEDES AXLES, SAE DUPILLIER, SAF / SAUER, TRAILERS, YORK, ZF AXLES
ACV043	BPW AXLES, DISCOS, GRANNING LYNX, KNORR - BREMSSEN, SAE DUPILLIER, SAF / SAUER, TRAILERS, ZF AXLES
ACV044	BPW AXLES, GRANNING LYNX, SAE DUPILLIER, SAF / SAUER, ZF AXLES
ACV045	IVECO
ACV047	MERITOR, TRAILERS
ACV048	DISCOS, FRUEHAUF, MERCEDES AXLES, SAF / SAUER, TRAILERS, WABCO BRAKES
ACV049	DAF, DISCOS, FRUEHAUF, MERCEDES AXLES, SAF / SAUER, TRAILERS, WABCO BRAKES
ACV050	MERITOR, TRAILERS, VOLVO
ACV051	MERITOR, TRAILERS, VOLVO
ACV053	FRUEHAUF, HALDEX BRAKES, MERCEDES AXLES, TRAILERS
ACV054	DISCOS, FRUEHAUF, HALDEX BRAKES, MERCEDES AXLES, SAF / SAUER, TRAILERS
ACV055	MERITOR, TRAILERS, VOLVO
ACV056	AUTODROMO, MERITOR, TRAILERS
ACV057	DEN OUDSTEN, MERITOR, TRAILERS
ACV058	ERF, MAN, MERITOR, RENAULT, TRAILERS



# Disc Brake Pads Vehicle Applications

**ANL**  
**Braking**

<b>PART NUMBER</b>	<b>VEHICLE APPLICATION</b>
ACV059	DAF, DENNIS
ACV060	RENAULT
ACV061	BPW AXLES, KNORR - BREMSSEN, TRAILERS, ZF AXLES
ACV062	BPW AXLES, KNORR - BREMSSEN, TRAILERS, ZF AXLES
ACV063	BPW AXLES, KNORR - BREMSSEN, MERCEDES, TRAILERS, ZF AXLES
ADB0101	VOLKSWAGEN
ADB0111	HYUNDAI, NISSAN
ADB0112	FIAT, FSO
ADB0118	FORD
ADB0122	NISSAN
ADB0124	VOLKSWAGEN
ADB0125	MERCEDES
ADB0128	VOLKSWAGEN
ADB0129	FIAT, SEAT
ADB0130	SUZUKI, VAUXHALL
ADB0132	FORD
ADB0134	VAUXHALL
ADB0135	VAUXHALL
ADB0142	FSO
ADB0147	MERCEDES
ADB0149	SEAT, VOLKSWAGEN
ADB0152	VOLKSWAGEN
ADB0156	FORD
ADB0162	LAND ROVER
ADB0168	KIA, MAZDA
ADB0171	NISSAN
ADB0177	L.D.V, NISSAN
ADB0183	MERCEDES, NISSAN, RENAULT
ADB0186	VOLKSWAGEN
ADB0195	SUZUKI
ADB0201	FIAT
ADB0207	NISSAN, SUBARU
ADB0212	MERCEDES, VOLKSWAGEN
ADB0224	LAND ROVER
ADB0225	HYUNDAI
ADB0228	FIAT
ADB0232	LAND ROVER
ADB0238	MERCEDES
ADB0239	FORD, L.D.V, VAUXHALL
ADB0243	FSO
ADB0247	VOLKSWAGEN
ADB0256	TATA
ADB0258	PEUGEOT, RENAULT
ADB0264	TOYOTA
ADB0265	TOYOTA
ADB0271	MERCEDES, VOLKSWAGEN
ADB0272	VOLKSWAGEN
ADB0276	NISSAN
ADB0297	TOYOTA, VOLKSWAGEN
ADB0306	ISUZU, VAUXHALL
ADB0312	STEYR-DAIMLER-PUCH
ADB0313	MAZDA
ADB0316	MAZDA, MITSUBISHI
ADB0319	ALFA ROMEO, FORD, IVECO, L.D.V, LAND ROVER, TAXIS
ADB0323	MAZDA



# Disc Brake Pads Vehicle Applications

**ANL**  
**Braking**

<b>PART NUMBER</b>	<b>VEHICLE APPLICATION</b>
ADB0368	NISSAN
ADB0389	FORD
ADB0390	FORD
ADB0391	NISSAN
ADB0393	FORD
ADB0397	FORD
ADB0401	LAND ROVER, MCW, TAXIS
ADB0419	VOLKSWAGEN
ADB0423	FORD, NISSAN
ADB0431	RENAULT
ADB0440	TOYOTA
ADB0444	FORD
ADB0447	FORD, L.D.V, NISSAN
ADB0453	MERCEDES, VOLKSWAGEN
ADB0459	TOYOTA
ADB0467	ROVER
ADB0478	MERCEDES, VOLKSWAGEN
ADB0479	FIAT
ADB0480	MERCEDES
ADB0485	RENAULT
ADB0502	FORD
ADB0511	SEAT, VOLKSWAGEN
ADB0515	PEUGEOT
ADB0552	SUBARU
ADB0567	FORD
ADB0570	PEUGEOT
ADB0589	TOYOTA
ADB0706	VOLKSWAGEN
ADB0707	SKODA
ADB0731	VAUXHALL
ADB0733	MAZDA
ADB0734	SUZUKI
ADB0758	NISSAN
ADB0770	DAIHATSU, PIAGGIO
ADB0873	LAND ROVER
ADB0874	NISSAN, OPEL, RENAULT, VAUXHALL, VOLKSWAGEN
ADB0876	FORD
ADB0888	MERCEDES
ADB0891	FORD
ADB0892	CITROEN, PEUGEOT
ADB0899	FORD
ADB0909	IVECO
ADB0914	MERCEDES, VOLKSWAGEN
ADB0924	FORD
ADB0925	VOLKSWAGEN
ADB0928	SKODA, VOLKSWAGEN
ADB0931	IVECO, RENAULT
ADB0952	SUBARU
ADB0953	VOLKSWAGEN
ADB0989	VOLKSWAGEN
ADB0991	MERCEDES, NISSAN, RENAULT
ADB01018	FIAT
ADB01021	OPEL, RENAULT, VAUXHALL
ADB01034	IVECO
ADB01035	NISSAN, OPEL, RENAULT, VAUXHALL



# Disc Brake Pads Vehicle Applications

**ANL**  
**Braking**

<b>PART NUMBER</b>	<b>VEHICLE APPLICATION</b>
ADB01036	NISSAN, OPEL, RENAULT, VAUXHALL
ADB01042	CITROEN, FIAT, PEUGEOT
ADB01052	LAND ROVER
ADB01066	FORD, L.D.V, LAND ROVER, RENAULT
ADB01073	VOLKSWAGEN
ADB01078	LAND ROVER
ADB01086	MITSUBISHI
ADB01087	MITSUBISHI
ADB01088	MITSUBISHI
ADB01089	MERCEDES
ADB01093	LAND ROVER
ADB01127	NISSAN, OPEL, RENAULT, VAUXHALL
ADB01150	FORD
ADB01153	FORD
ADB01157	LAND ROVER
ADB01173	IVECO
ADB01175	ISUZU
ADB1133	RENAULT
ADB1142	FSO
ADB1174	CITROEN, PEUGEOT
ADB1183	MERCEDES, NISSAN, RENAULT
ADB1191	CITROEN
ADB1204	SUZUKI
ADB1205	PEUGEOT
ADB1224	LAND ROVER
ADB1228	FIAT
ADB1235	IVECO, TALBOT
ADB1254	ALFA ROMEO, CITROEN, FIAT, IVECO, PEUGEOT, TALBOT
ADB1275	CITROEN, FIAT, PEUGEOT
ADB1308	PEUGEOT
ADB1319	ALFA ROMEO, IVECO
ADB1392	ROVER
ADB1396	ROVER
ADB1401	TAXIS
ADB1412	ALFA ROMEO, IVECO
ADB1413	LAND ROVER
ADB1419	VOLKSWAGEN
ADB1431	RENAULT
ADB1437	ALFA ROMEO, IVECO
ADB1455	MERCEDES
ADB1479	FIAT
ADB1515	PEUGEOT
ADB1570	PEUGEOT
ADB1852	VOLKSWAGEN
ADB1874	VOLKSWAGEN
ADB1907	VOLKSWAGEN
ADB1926	PEUGEOT
ADB1953	VOLKSWAGEN
ADB1991	MERCEDES, NISSAN, RENAULT
ADB11001	CITROEN, FIAT, PEUGEOT
ADB11028	IVECO
ADB11029	IVECO
ADB11030	IVECO
ADB11031	FIAT
ADB11032	FIAT



# Disc Brake Pads Vehicle Applications

**ANL**  
**Braking**

<b>PART NUMBER</b>	<b>VEHICLE APPLICATION</b>
ADB11040	CITROEN, FIAT, PEUGEOT
ADB11041	CITROEN, FIAT, PEUGEOT
ADB11047	ALFA ROMEO, FIAT, IVECO
ADB11051	IVECO
ADB11054	ALFA ROMEO, IVECO
ADB11055	LAND ROVER
ADB11059	ALFA ROMEO, IVECO
ADB11068	IVECO
ADB11069	ALFA ROMEO, IVECO
ADB11151	VOLKSWAGEN
ADB11168	VOLKSWAGEN
ADB2219	CITROEN, FIAT, PEUGEOT
ADB2258	PEUGEOT, RENAULT
ADB2310	CITROEN
ADB2416	PEUGEOT
ADB2485	RENAULT
ADB2533	RENAULT
ADB2714	CITROEN, FIAT, PEUGEOT
ADB21048	RENAULT, VAUXHALL
ADB3168	KIA, MAZDA
ADB3207	NISSAN, SUBARU
ADB3225	HYUNDAI
ADB3232	LAND ROVER
ADB3233	MITSUBISHI
ADB3234	MITSUBISHI
ADB3269	MITSUBISHI
ADB3273	SUZUKI
ADB3285	MITSUBISHI
ADB3295	MITSUBISHI
ADB3320	MAZDA
ADB3322	ISUZU, VAUXHALL
ADB3330	NISSAN
ADB3333	TOYOTA, VOLKSWAGEN
ADB3368	NISSAN
ADB3387	L.D.V, NISSAN
ADB3393	FORD
ADB3399	SUBARU
ADB3400	SUBARU
ADB3402	SUBARU
ADB3422	TOYOTA
ADB3439	DAIHATSU
ADB3451	SUBARU
ADB3457	DAIHATSU
ADB3481	HYUNDAI
ADB3518	SUBARU
ADB3583	OPEL, VAUXHALL
ADB3584	OPEL, VAUXHALL
ADB3587	SUZUKI
ADB3721	KIA
ADB3746	TOYOTA
ADB3750	OPEL, VAUXHALL
ADB3812	ISUZU
ADB3813	PROTON
ADB3863	FORD, NISSAN
ADB3887	FORD





# Disc Brake Pads Vehicle Applications

**ANL**  
**Braking**

<b>PART NUMBER</b>	<b>VEHICLE APPLICATION</b>
ADB3918	ISUZU
ADB3919	ISUZU
ADB3924	FORD
ADB3945	PROTON
ADB31014	FORD
ADB31090	TOYOTA
ADB31107	FORD
ADB31108	FORD
ADB31112	OPEL, VAUXHALL
ADB31113	SUZUKI
ADB31161	OPEL, VAUXHALL
ADB31174	ISUZU
ADB4129	FIAT, SEAT
ADB4137	FIAT
ADB4311	RENAULT
OTR162	MERCEDES



## Application Data

---

SECTION

B

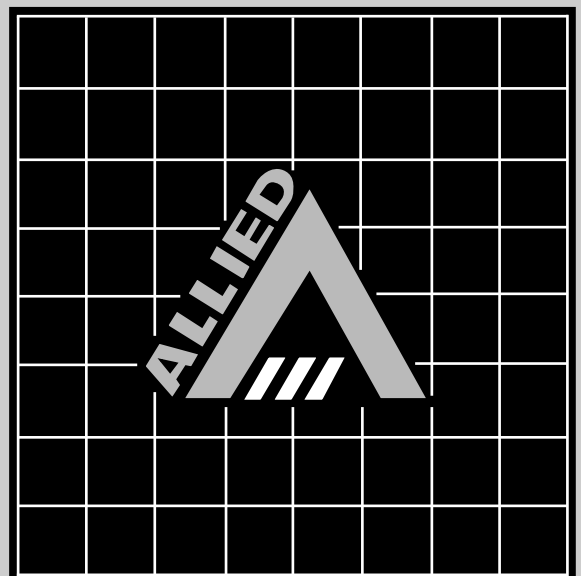



# How to use this Catalogue

# ANL Braking



ALFA ROMEO										
AR 6 Van 10-13 Petrol  Diesel	F	10/81-06/84	Lucas		256	ADB1254	20741			
	F	06/84-01/95	Lucas		256	ADB1254	20741			
	F	06/84-01/95	Lucas		256		21205			
AR 8 Van 30, 32	F	01/79-01/82	Lockheed		267	ADB0319	20359			
	F	01/82-01/86	Lockheed		267	ADB0319 <sup>①</sup>	20359			
	F	01/82-01/86	Lockheed		267	ADB1412 <sup>①</sup>	20359			
	F	01/86-01/90	Lockheed		267	ADB0319 <sup>①</sup>	20359			
	F	01/86-01/90	Lockheed		267	ADB11059 <sup>①</sup>	20359			
	F	01/90-01/96	Lockheed		267	ADB0319	20359			
	F	01/90-01/96	Lockheed		267	ADB1319	21160			
	F	01/82-01/86	Brembo		267	ADB11047	21049			
	F	01/86-01/90	Brembo		267	ADB11054	21188			
	F	01/90-01/96	Brembo		267	ADB11069	29037			
AR 8 Van 35, 40	F	01/79-01/82	Lockheed		267	ADB0319	20359			
	F	01/82-01/86	Lockheed		267	ADB0319 <sup>①</sup>	20359			
	F	01/82-01/86	Lockheed		267	ADB1412 <sup>①</sup>	20359			
	F	01/86-01/90	Lockheed		267	ADB0319 <sup>①</sup>	20359			
	F	01/86-01/90	Lockheed		267	ADB11059 <sup>①</sup>	20359			
	F	01/90-01/96	Lockheed		267	ADB0319	20359			
	F	01/90-01/96	Lockheed		267	ADB1319	21160			
	F	01/82-01/86	Brembo		267	ADB11047	21049			

Note: <sup>①</sup> Use illustrations to determine correct pad fitment

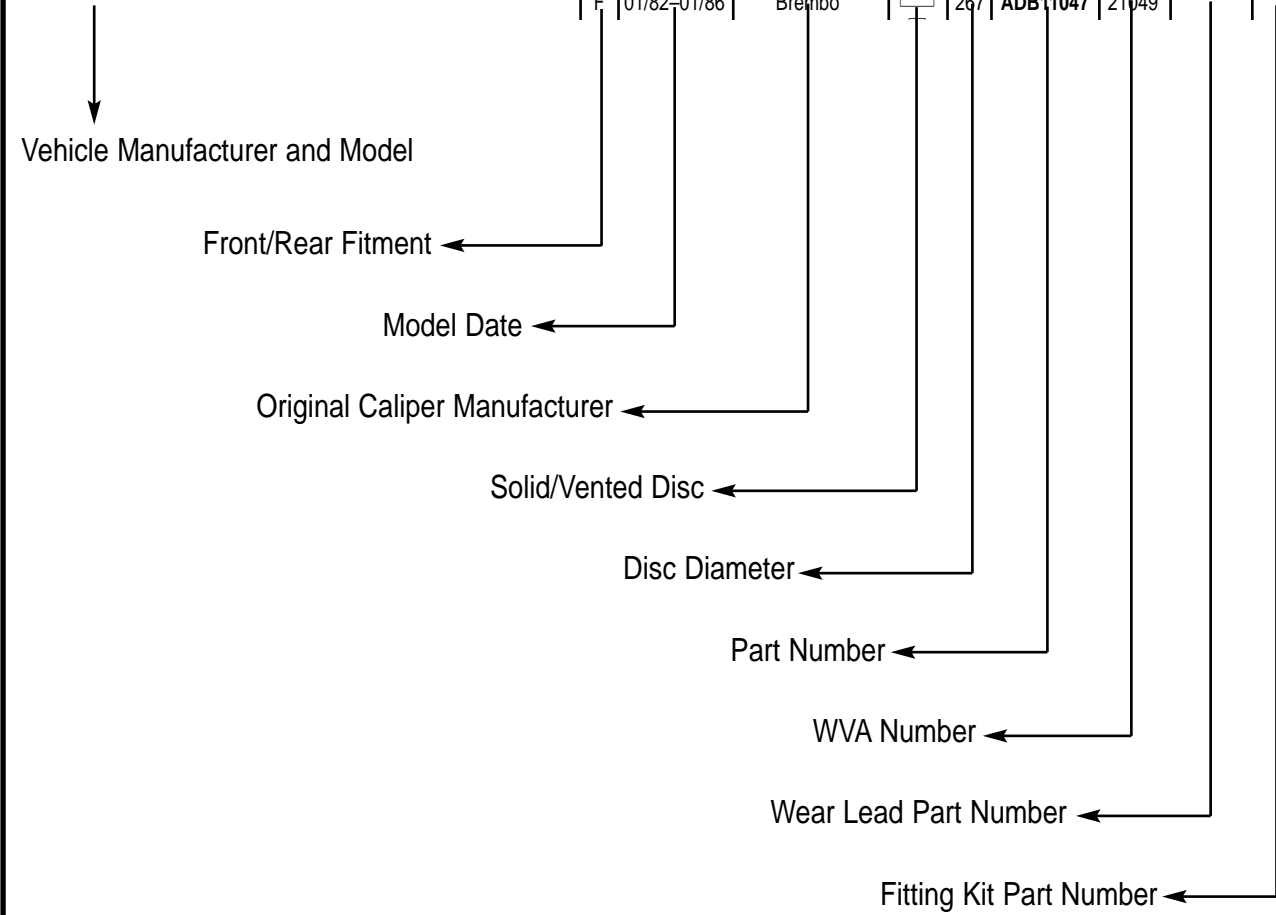



































# Application Data

## Brake Pads, Wear Leads and Fitting Kits

# ANL Braking

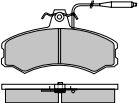
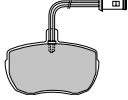
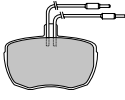
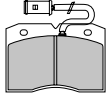
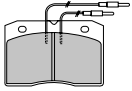
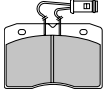
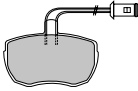
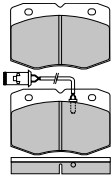
									
<b>ALFA ROMEO</b>									
<b>AR 6 Van</b> 10-13 Petrol  Diesel	F	10/81-06/84	Lucas		256	<b>ADB1254</b>	20741		
	F	06/84-01/95	Lucas		256	<b>ADB1254</b>	20741		
	F	06/84-01/95	Lucas		256		21205		
<b>AR 8 Van</b> 30, 32	F	01/79-01/82	Lockheed		267	<b>ADB0319</b>	20359		
	F	01/82-01/86	Lockheed		267	<b>ADB0319</b> Ⓢ	20359		
	F	01/82-01/86	Lockheed		267	<b>ADB1412</b> Ⓢ	20359		
	F	01/86-01/90	Lockheed		267	<b>ADB0319</b> Ⓢ	20359		
	F	01/86-01/90	Lockheed		267	<b>ADB11059</b> Ⓢ	20359		
	F	01/90-01/96	Lockheed		267	<b>ADB0319</b>	20359		
	F	01/90-01/96	Lockheed		267	<b>ADB1319</b>	21160		
	F	01/82-01/86	Brembo		267	<b>ADB11047</b>	21049		
	F	01/86-01/90	Brembo		267	<b>ADB11054</b>	21188		
	F	01/90-01/96	Brembo		267	<b>ADB11069</b>	29037		
<b>Note: Ⓢ Use illustrations to determine correct pad fitment</b>									
<b>AR 8 Van</b> 35, 40	F	01/79-01/82	Lockheed		267	<b>ADB0319</b>	20359		
	F	01/82-01/86	Lockheed		267	<b>ADB0319</b> Ⓢ	20359		
	F	01/82-01/86	Lockheed		267	<b>ADB1412</b> Ⓢ	20359		
	F	01/86-01/90	Lockheed		267	<b>ADB0319</b> Ⓢ	20359		
	F	01/86-01/90	Lockheed		267	<b>ADB11059</b> Ⓢ	20359		
	F	01/90-01/96	Lockheed		267	<b>ADB0319</b>	20359		
	F	01/90-01/96	Lockheed		267	<b>ADB1319</b>	21160		
	F	01/82-01/86	Brembo		267	<b>ADB11047</b>	21049		
	F	01/86-01/90	Brembo		267	<b>ADB11054</b>	21188		
	F	01/90-01/96	Brembo		267	<b>ADB1437</b>	29041		
<b>Note: Ⓢ Use illustrations to determine correct pad fitment</b>									
<b>ADB0319</b>		<b>ADB1254</b>		<b>ADB1319</b>		<b>ADB1412</b>		<b>ADB1437</b>	
									
104.9 × 74.7 × 18		130.0 × 71.5 × 19		104.9 × 74.7 × 18		104.9 × 74.7 × 18		109.7 × 73.0 × 18.3	
<b>ADB11047</b>		<b>ADB11054</b>		<b>ADB11059</b>		<b>ADB11069</b>			
									
109.7 × 73.0 × 18.3		109.7 × 73.0 × 18.3		104.9 × 74.7 × 18		110.0 × 73.0 × 18.5			
<b>Where more than one part number is shown, use illustrations to determine correct pad fitment for the application</b>									



# Application Data

## Brake Pads, Wear Leads and Fitting Kits

# ANL Braking

						ACV/ADB	WVA NO.	WL	K
<b>AUTODROMO</b>									
PSV Leggero Bus	F	01/98→	Meritor (Lucas)			ACV056	29149		K014
<p>ACV056</p> <p>179.5 × 95 × 28</p>									
<b>AUWARTER</b>									
Cityliner N116, N116H, N116/3, N116/3H	F	01/92→	Knorr		430	ACV041	29106	WL009	K005/ K018
Clubstar SB 6000	F	01/98→	Knorr		377	ACV036 <sup>①</sup>	29093	WL015	K005/ K018
	F	01/98→	Knorr		377	ACV037 <sup>②</sup>	29095	WL015	K005/ K018
	R	01/98→	Knorr		377	ACV036 <sup>①</sup>	29093	WL015	K005/ K018
	R	01/98→	Knorr		377	ACV037 <sup>②</sup>	29095	WL015	K005/ K018
Note: Disc Th 45→41mm use <sup>①</sup> , 41→38mm use <sup>②</sup>									
Economy 17.5" wheels	F	01/98→	Meritor (Lucas)		324	ACV002 <sup>①</sup>	29835	WL028	
	R	01/98→	Meritor (Lucas)		324	ACV002 <sup>①</sup>	29835	WL028	
Note: <sup>①</sup> Replaced by ACV032, see Technical Bulletin #001									
Euroliner SB 7000	F	01/92→	Knorr		430	ACV041	29106	WL009	K005/ K018
Eurostar 0404 (10R → 15R)	F	10/91→	Meritor (Lucas)		438	ACV014 <sup>①</sup>	29030		K002/ K016
	F	10/91→	Meritor (Lucas)		438	ACV030 <sup>②</sup>	29053		K013/ K016
	R	10/91→	Meritor (Lucas)		438	ACV014 <sup>①</sup>	29030		K002/ K016
	R	10/91→	Meritor (Lucas)		438	ACV030 <sup>②</sup>	29053		K013/ K016
Note: Disc Th 45→41mm use <sup>①</sup> , 41→38mm use <sup>②</sup>									
Jetliner N407, N409	F	→09/85	Knorr		315	ACV006	29747		K001

Where more than one part number is shown, use illustrations to determine correct pad fitment for the application



# Application Data

## Brake Pads, Wear Leads and Fitting Kits

# ANL

## Braking

					ACV/ADB	WVA NO.	WL	K
					mm			
<b>AUWARTER – cont.</b>								
<b>Jetliner</b> N212H, N213H, N213SHD, N214H, N214SHD	F	09/85–01/92	Knorr			29688		
<b>Jetliner</b> SB 7000	F	01/92→	Knorr		430	<b>ACV041</b>	29106	<b>WL009</b> <b>K005/K018</b>
<b>Metroliner</b>	F	→01/94	Knorr			<b>ACV006</b>	29747	<b>K001</b>
	F	01/94–01/97	Knorr				29688	
<b>Metroliner</b> 17.5" wheels	F	01/97→	Wabco / Perrot		324	<b>ACV025</b> <sup>①</sup>	29055	<b>WL015</b>
	R	01/97→	Wabco / Perrot		324	<b>ACV025</b> <sup>①</sup>	29055	<b>WL015</b>
<b>Note: ① Replaced by ACV032, see Technical Bulletin #001</b>								
<b>Neoplan</b> N4007, N4009, N4014, N4016, N4021	F	01/92→	Knorr			<b>ACV006</b>	29747	<b>K001</b>
<b>N Series Bus</b> N4008 → N4026	F	01/92→	Knorr		430	<b>ACV041</b>	29106	<b>WL009</b> <b>K005/K018</b>
<b>Regioliner</b> N3014, N3016	F	01/92→	Knorr		430	<b>ACV041</b>	29106	<b>WL009</b> <b>K005/K018</b>
<b>Skyliner</b> N122/3	F	01/92→	Knorr		430	<b>ACV041</b>	29106	<b>WL009</b> <b>K005/K018</b>
<b>Spaceliner</b> N117/2, N117/3	F	01/92→	Knorr		430	<b>ACV041</b>	29106	<b>WL009</b> <b>K005/K018</b>
<b>Starliner</b> SB 7000	F	01/92→	Knorr		430	<b>ACV041</b>	29106	<b>WL009</b> <b>K005/K018</b>
<b>Teamstar</b> 17.5" wheels	F	01/98→	Meritor (Lucas)		324	<b>ACV002</b> <sup>①</sup>	29835	<b>WL028</b>
	R	01/98→	Meritor (Lucas)		324	<b>ACV002</b> <sup>①</sup>	29835	<b>WL028</b>
<b>Note: ① Replaced by ACV032, see Technical Bulletin #001</b>								
<b>Transliner</b> N312, N316	F	01/92→	Knorr		430	<b>ACV041</b>	29106	<b>WL009</b> <b>K005/K018</b>

**ACV002**

**ACV006**

**ACV014**

**ACV025**

**ACV030**

Replaced by **ACV032**

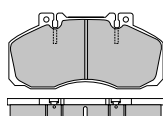

173.0 × 83.0 × 21.5

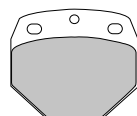

140.0 × 121.0 × 32

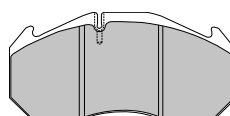

250.0 × 118.0 × 28

Replaced by **ACV032**

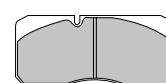

176.0 × 83.0 × 22

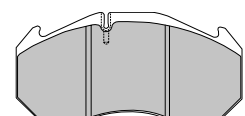

250.0 × 118.0 × 28

Where more than one part number is shown, use illustrations to determine correct pad fitment for the application





# Application Data

## Brake Pads, Wear Leads and Fitting Kits

# ANL Braking



mm



ACV/ADB

WVA NO.

WL

K

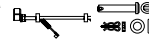

### AUWARTER – cont.

ACV036

ACV037

ACV041

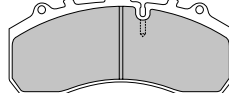
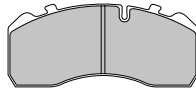
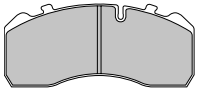

210.7 × 92.5 × 30

210.7 × 92.5 × 30

248.0 × 108.0 × 30

### AVIA (DAEWOO)

see DAEWOO (AVIA)

### AWD

TL Series  
TL 7.14

F	01/92→	Meritor (Lucas)		ACV004 <sup>①</sup>	29302		
F	01/92→	Meritor (Lucas)		ACV007 <sup>①</sup>	29033		
R	01/92→	Meritor (Lucas)		ACV004 <sup>①</sup>	29302		
R	01/92→	Meritor (Lucas)		ACV007 <sup>①</sup>	29033		

Note: <sup>①</sup> Replaced by ACV032, see Technical Bulletin #001

TL Series  
TL 8.14

F	01/92→	Meritor (Lucas)		ACV004 <sup>①</sup>	29302		
F	01/92→	Meritor (Lucas)		ACV007 <sup>①</sup>	29033		
R	01/92→	Meritor (Lucas)		ACV004 <sup>①</sup>	29302		
R	01/92→	Meritor (Lucas)		ACV007 <sup>①</sup>	29033		

Note: <sup>①</sup> Replaced by ACV032, see Technical Bulletin #001

TL Series  
TL 9.14

F	01/92→	Meritor (Lucas)		ACV004 <sup>①</sup>	29302		
F	01/92→	Meritor (Lucas)		ACV007 <sup>①</sup>	29033		
R	01/92→	Meritor (Lucas)		ACV004 <sup>①</sup>	29302		
R	01/92→	Meritor (Lucas)		ACV007 <sup>①</sup>	29033		

Note: <sup>①</sup> Replaced by ACV032, see Technical Bulletin #001

TL Series  
TL 12.16

F	01/92→	Meritor (Lucas)		ACV004 <sup>①</sup>	29302		
F	01/92→	Meritor (Lucas)		ACV007 <sup>①</sup>	29033		
R	01/92→	Meritor (Lucas)		ACV004 <sup>①</sup>	29302		
R	01/92→	Meritor (Lucas)		ACV007 <sup>①</sup>	29033		

Note: <sup>①</sup> Replaced by ACV032, see Technical Bulletin #001

Where more than one part number is shown, use illustrations to determine correct pad fitment for the application



# Application Data

## Brake Pads, Wear Leads and Fitting Kits

# ANL

## Braking

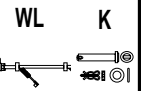

### AWD – cont.

ACV004

ACV007

Replaced by **ACV032**

Replaced by **ACV032**

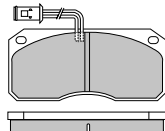
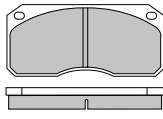

177 × 77.0 × 22

177 × 77 × 22

### BEDFORD

see VAUXHALL LCV

### BERLIET

see RVI

### BOVA

see DAF

### BPW AXLES

#### Eco Plus

SB 6000

19.5" wheels  
non ABS

ABS

01/98→

Knorr



370

**ACV043**<sup>①</sup>

29095

WL015

K005/  
K018

01/98→

Knorr



370

**ACV044**<sup>②</sup>

29095

WL015

K005/  
K018

01/98→

Knorr



370

**ACV043**<sup>①</sup>

29095

WL015

K005/  
K018

01/98→

Knorr



370

**ACV044**<sup>②</sup>

29095

WL015

K005/  
K018

Note: Disc Th 45→41mm use <sup>①</sup>, 41→38mm use <sup>②</sup>

#### Eco Plus

SB 7000

22.5" wheels  
non ABS

ABS

01/98→

Knorr



430

**ACV042**

29108

K005/  
K018

01/98→

Knorr



430

**ACV042**

29108

K005/  
K018

#### SB Series

SB3745

19.5" wheels  
non ABS

01/98→

Knorr



370

**ACV043**<sup>①</sup>

29095

WL015

K005/  
K018

01/98→

Knorr



370

**ACV044**<sup>②</sup>

29095

WL015

K005/  
K018

Note: Disc Th 45→41mm use <sup>①</sup>, 41→38mm use <sup>②</sup>

#### SB Series

SB4345

non ABS

ABS

01/91→

Knorr



430

**ACV042**

29108

K005/  
K018

01/91→

Knorr



430

**ACV042**

29108

K005/  
K018

Where more than one part number is shown, use illustrations to determine correct pad fitment for the application



# Application Data

## Brake Pads, Wear Leads and Fitting Kits

# ANL

## Braking

<b>BPW AXLES – cont.</b>										
<b>SB Series</b>										
SB 6000 19.5" wheels non ABS										
			01/98→	Knorr		370	ACV043 <sup>①</sup>	29095	WL015	K005/ K018
			01/98→	Knorr		370	ACV044 <sup>②</sup>	29095	WL015	K005/ K018
ABS										
			01/98→	Knorr		370	ACV043 <sup>①</sup>	29095	WL015	K005/ K018
			01/98→	Knorr		370	ACV044 <sup>②</sup>	29095	WL015	K005/ K018
<b>Note: Disc Th 45→41mm use <sup>①</sup>, 41→38mm use <sup>②</sup></b>										
<b>SB Series</b>										
SB 7000 22.5" wheels non ABS										
			01/98→	Knorr		430	ACV042	29108		K005/ K018
ABS										
			01/98→	Knorr		430	ACV042	29108		K005/ K018
<b>SHS Series</b>										
SB 7000										
			01/98→	Knorr		430	ACV042	29108		K005/ K018
<b>SHZ Series</b>										
SB 7000										
			01/98→	Knorr		430	ACV042	29108		K005/ K018
<b>with Knorr brakes</b>										
SB 6000 19.5" wheels										
			01/98→	Knorr		370	ACV043 <sup>①</sup>	29095	WL015	K005/ K018
			01/98→	Knorr		370	ACV044 <sup>②</sup>	29095	WL015	K005/ K018
<b>Note: Disc Th 45→41mm use <sup>①</sup>, 41→38mm use <sup>②</sup></b>										
<b>with Knorr brakes</b>										
SN 6000 19.5" wheels										
			06/03→	Knorr		370	ACV061	29165		K005/ K018
			06/03→	Knorr		370	ACV062	29171		K005/ K018
<b>with Knorr brakes</b>										
SB 7000 22.5" wheels										
			01/98→	Knorr		430	ACV042	29108		K005/ K018
<b>with Knorr brakes</b>										
SN 7000 22.5" wheels										
			06/03→	Knorr		430	ACV063	29167		K005/ K018

Where more than one part number is shown, use illustrations to determine correct pad fitment for the application



# Application Data

## Brake Pads, Wear Leads and Fitting Kits

# ANL

## Braking



WL

K

### BPW AXLES – cont.

ACV042

ACV043

ACV044

ACV061

ACV062

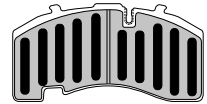
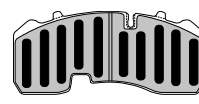
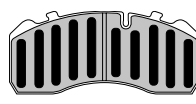
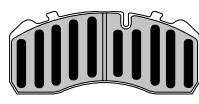
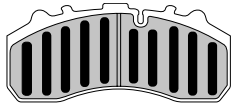

248.0 × 108.0 × 30

210.7 × 92.5 × 30

210.7 × 92.5 × 30

210 × 92 × 29

210 × 108 × 29

ACV063



247 × 110 × 29

### CARBODIES

see TAXI

### CITROEN

**Berlingo**  
1.4

F	01/97→	Lucas		266	<b>ADB0892</b>	23346
F	01/97→	Lucas		266	<b>ADB1174</b>	23124
F	01/97→	Lucas		266	<b>ADB0892</b>	23346
F	01/97→	Lucas		266	<b>ADB1174</b>	23124

**Berlingo**  
1.8 D, 1.9 D

F	01/97→	Lucas		266	<b>ADB0892</b>	23346
F	01/97→	Lucas		266	<b>ADB1174</b>	23124
F	01/97→	Lucas		266	<b>ADB0892</b>	23346
F	01/97→	Lucas		266	<b>ADB1174</b>	23124

**C15 Van / Champ**  
Petrol

F	10/84–01/89	Bendix		244	<b>ADB2310</b>	20635
F	10/84–01/89	Citroen		244		20594
F	01/89→	Lucas		247	<b>ADB1191</b>	20989

**C15 Van / Champ**  
Diesel

F	10/84→	Lucas		247	<b>ADB1191</b>	20989
---	--------	-------	--	-----	----------------	-------

**C22 Van**

F	10/81–06/84	Lucas		256	<b>ADB1254</b>	20741
F	06/84–01/95	Lucas		256	<b>ADB1254</b>	20741

**C25 Van**  
Petrol

F	10/81–06/84	Lucas		256	<b>ADB1254</b>	20741
F	06/84–01/95	Lucas		256	<b>ADB1254</b>	20741

**C25 Van**  
Diesel

F	06/84–01/95	Lucas		256		21205
---	-------------	-------	--	-----	--	-------

Where more than one part number is shown, use illustrations to determine correct pad fitment for the application



# Application Data

## Brake Pads, Wear Leads and Fitting Kits

# ANL

## Braking

						ACV/ADB	WVA NO.	WL	K
						mm			
<b>CITROEN – cont.</b>									
<b>C25 Van</b> Turbo Diesel 1.8 ton	F	01/87–01/95	Lucas		290		21205		
<b>C32, C35 Van</b>          Handbrake pads	F	01/74–01/79	Citroen		285	ADB1254	20741		
	F	01/79–01/81	Citroen		285				
	F	01/79–01/81	Citroen		285				
	F	01/81–01/95	Lucas		285				
	R	01/74–01/79	Citroen		279				
	R	01/74–01/79	Citroen		279				
	R	01/79–01/81	Citroen		279				
	R	01/79–01/81	Citroen		279				
	R	01/74–01/81	Citroen		279				
	<b>Dispatch / Jumpy</b> 1.6i	F	01/96→	Bendix		257	ADB2714	23003	
F		01/96→	Lucas		281	ADB11001	21801		
<b>Dispatch / Jumpy</b> 1.9 D, 1.9 TD	F	01/96→	Bendix		257	ADB2714	23003		
	F	01/96→	Lucas		281	ADB11001	21801		
<b>Dispatch / Jumpy</b> 2.0 HDi	F	09/99→	Bendix		257	ADB2714	23003		
	F	09/99→	Lucas		281	ADB11001	21801		
<b>Relay / Jumper →01/02</b> 1.0 Tonne 1.9 D, 1.9 TD, 2.0i, 2.5 D, 2.5 TD	F	02/94–01/02	Lucas		280	ADB2219	21627		
	F	02/94–01/02	Lucas		280	ADB2219	21627		
<b>Relay / Jumper →01/02</b> 1.4 Tonne 1.9 D, 1.9 TD, 2.0i, 2.5 D, 2.5 TD	F	02/94–01/02	Lucas		280	ADB2219	21627		
	F	02/94–01/02	Lucas		280	ADB2219	21627		
<b>Relay / Jumper →01/02</b> 1.8 Tonne 2.0i non ABS ABS 2.5 D, 2.5 TD non ABS ABS	F	02/94–01/02	Lucas		300	ADB1275	21629		
	F	02/94–01/02	Lucas		300	ADB1275	21629		
	F	02/94–01/02	Lucas		300	ADB1275	21629		
	F	02/94–01/02	Lucas		300	ADB1275	21629		
<b>Relay / Jumper 01/02→</b> 11	F	01/02→	Brembo		280	ADB11040	23602		
	R	01/02→	Brembo		280	ADB01042			
<b>Relay / Jumper 01/02→</b> 15	F	01/02→	Brembo		280	ADB11040	23602		
	R	01/02→	Brembo		280	ADB01042			
<b>Relay / Jumper 01/02→</b> 18	F	01/02→	Brembo		300	ADB11041	23603		
	R	01/02→	Brembo		280	ADB01042			

Where more than one part number is shown, use illustrations to determine correct pad fitment for the application



# Application Data

## Brake Pads, Wear Leads and Fitting Kits

# ANL Braking



WL

K

### CITROEN – cont.

ADB0892

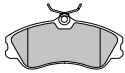

130 × 56 × 17.5

ADB01042



110 × 50 × 20

ADB1174

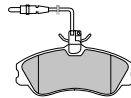

130 × 56 × 17.5

ADB1191

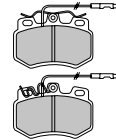

89.9 × 58.8 × 17.5

ADB1254

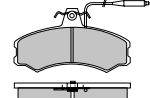

130.0 × 71.5 × 19

ADB1275

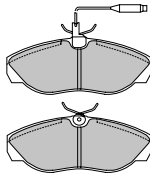

160.0 × 65.0 × 19

ADB2219

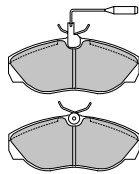

145.0 × 62.0 × 19

ADB2310

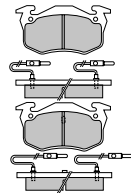

105.0 × 54.5 × 18

ADB2714

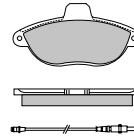

140 × 69 × 18.3

ADB11001

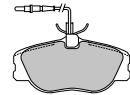

130.0 × 60.0 × 18

ADB11040

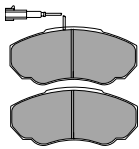

141 × 66 × 19

ADB11041

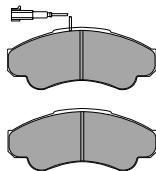

165 × 70 × 19

### CRANE FRUEHAUF

see FRUEHAUF

### DAEWOO (AVIA)

A60

F 01/97→  
F 01/97→

Wabco / Perrot  
Wabco / Perrot

314  
 314

ACV001 29017  
ACV003 29024

A75

F 01/97→  
F 01/97→

Wabco / Perrot  
Wabco / Perrot

314  
 314

ACV001 29017  
ACV003 29024

A80

F 01/97→  
F 01/97→

Wabco / Perrot  
Wabco / Perrot

314  
 314

ACV001 29017  
ACV003 29024

D60

F 10/00→  
F 10/00→

Wabco / Perrot  
Wabco / Perrot

314  
 314

ACV001 29017  
ACV003 29024

Where more than one part number is shown, use illustrations to determine correct pad fitment for the application





# Application Data

## Brake Pads, Wear Leads and Fitting Kits

# ANL Braking

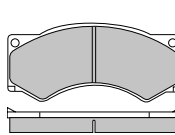
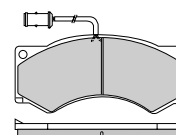
						ACV/ADB	WVA NO.	WL	K
						mm			
<b>DAEWOO (AVIA) – cont.</b>									
D75	F	10/00→	Wabco / Perrot		314	ACV001	29017		
	F	10/00→	Wabco / Perrot		314	ACV003	29024		
D80	F	10/00→	Wabco / Perrot		314	ACV001	29017		
	F	10/00→	Wabco / Perrot		314	ACV003	29024		
D95	F	10/00→	Wabco / Perrot		314	ACV001	29017		
	F	10/00→	Wabco / Perrot		314	ACV003	29024		
<div style="display: flex; justify-content: space-around;"> <div style="text-align: center;"> <p><b>ACV001</b></p>  <p>191.0 × 87.0 × 23</p> </div> <div style="text-align: center;"> <p><b>ACV003</b></p>  <p>191.0 × 87.0 × 23</p> </div> </div>									
<b>DAF (Includes Bova, Futura, Leyland Daf)</b>									
<b>45 Series</b>									
FA45.120, FA45.130, FA45.150, FA45.160 4x2 Rigid, Tipper (6.2T → 7.5T)									
	F	01/91–01/01	Wabco / Perrot		315	ACV001	29017		
	F	01/91–01/01	Wabco / Perrot		315	ACV003	29024		
<b>45 Series</b>									
FA45.130, FA45.150, FA45.160 4x2 Rigid (10.0T → 11.0T)									
	F	01/91–01/01	Wabco / Perrot		312	ACV001	29017		
	F	01/91–01/01	Wabco / Perrot		312	ACV003	29024		
<b>45 Series</b>									
FA45.180, FA45.210 4x2 Rigid (10.0T → 11.0T)									
	F	01/91–01/01	Wabco / Perrot		312	ACV001	29017		
	F	01/91–01/01	Wabco / Perrot		312	ACV003	29024		
<b>50 Series</b>									
FA50.130, FA50.150, FA50.160, FA50.180 4x2 Rigid (11.0T → 18.0T)									
	F	01/93–03/96	Wabco / Perrot		375	ACV027	29077		
<b>55 Series</b>									
FA55.160, FA55.180, FA55.210 4x2 Rigid (11.0T → 18.0T)									
	F	01/93–03/96	Wabco / Perrot		375	ACV027	29077		
<b>55 Series</b>									
FA55.150, FA55.160, FA55.180, FA55.210 4x2 Rigid (11.0T → 15.0T)									
	F	01/95–01/02	Wabco / Perrot		375	ACV027	29077		
<b>55 Series</b>									
FA55.210, FA55.230 4x2 Drawbar (13.0T → 18.0T)									
	F	01/95–01/02	Wabco / Perrot		375	ACV027	29077		
<b>75 CF Series</b>									
250, 310, 360									
	F	01/01→	Knorr			ACV041	29106	WL009	K005/ K018 –cont.

Where more than one part number is shown, use illustrations to determine correct pad fitment for the application



# Application Data

## Brake Pads, Wear Leads and Fitting Kits

# ANL Braking

 	 	 	 			<b>WVA NO.</b>	<b>WL</b>	<b>K</b>	
<b>DAF – cont.</b> 75 CF Series – cont.	R	01/01→	Knorr			<b>ACV041</b>	29106	<b>WL009</b>	<b>K005/ K018</b>
<b>85 CF Series</b> 340, 380, 430	F	01/01→	Knorr			<b>ACV041</b>	29106	<b>WL009</b>	<b>K005/ K018</b>
	R	01/01→	Knorr			<b>ACV041</b>	29106	<b>WL009</b>	<b>K005/ K018</b>
<b>CF Series</b> FA65CF.210, FA65CF.240 4x2 Rigid, 4x2 Drawbar 17 T	F	01/98–01/01	Knorr			<b>ACV041</b>	29106	<b>WL009</b>	<b>K005/ K018</b>
	R	01/98–01/01	Knorr			<b>ACV041</b>	29106	<b>WL009</b>	<b>K005/ K018</b>
<b>CF Series</b> FA75CF.250, FA75CF.290, FA75CF.320 4x2 Rigid, 4x2 Drawbar 17 T	F	01/98–01/01	Knorr			<b>ACV041</b>	29106	<b>WL009</b>	<b>K005/ K018</b>
	R	01/98–01/01	Knorr			<b>ACV041</b>	29106	<b>WL009</b>	<b>K005/ K018</b>
<b>CF Series</b> FAG75CF.250, FAG75CF.290, FAG75CF.320 6x2 Twin steer Rigid 26 T	F	01/98–01/01	Knorr			<b>ACV041</b>	29106	<b>WL009</b>	<b>K005/ K018</b>
	R	01/98–01/01	Knorr			<b>ACV041</b>	29106	<b>WL009</b>	<b>K005/ K018</b>
<b>CF Series</b> FAN75CF.250, FAN75CF.290, FAN75CF.320 6x2 Rear steer Rigid 26 T	F	01/98–01/01	Knorr			<b>ACV041</b>	29106	<b>WL009</b>	<b>K005/ K018</b>
	R	01/98–01/01	Knorr			<b>ACV041</b>	29106	<b>WL009</b>	<b>K005/ K018</b>
<b>CF Series</b> FAS75CF.250, FAS75CF.290, FAS75CF.320 6x2 Rigid 26 T	F	01/98–01/01	Knorr			<b>ACV041</b>	29106	<b>WL009</b>	<b>K005/ K018</b>
	R	01/98–01/01	Knorr			<b>ACV041</b>	29106	<b>WL009</b>	<b>K005/ K018</b>
<b>CF Series</b> FAS75CF.250, FAS75CF.290, FAS75CF.320 6x2 Drawbar 26 T	F	01/98–01/01	Knorr			<b>ACV041</b>	29106	<b>WL009</b>	<b>K005/ K018</b> –cont.

Where more than one part number is shown, use illustrations to determine correct pad fitment for the application



# Application Data

## Brake Pads, Wear Leads and Fitting Kits

## ANL Braking

						ACV/ADB 	WVA NO.	WL 	K 
<b>DAF – cont.</b> CF Series – cont.	R	01/98–01/01	Knorr			ACV041	29106	WL009	K005/ K018
<b>CF Series</b> FAT75CF.250, FAT75CF.290, FAT75CF.320 6x4 Rigid, Tipper, Mixers 26 T	F	01/98–01/01	Knorr			ACV041	29106	WL009	K005/ K018
	R	01/98–01/01	Knorr			ACV041	29106	WL009	K005/ K018
<b>CF Series</b> FT75CF.250, FT75CF.290, FT75CF.320 4x2 Tractor	F	01/98–01/01	Knorr			ACV041	29106	WL009	K005/ K018
	R	01/98–01/01	Knorr			ACV041	29106	WL009	K005/ K018
<b>CF Series</b> FA85CF.340, FA85CF.380, FA85CF.430 4x2 Drawbar 17 T	F	01/98–01/01	Knorr			ACV041	29106	WL009	K005/ K018
	R	01/98–01/01	Knorr			ACV041	29106	WL009	K005/ K018
<b>CF Series</b> FAD85CF.340 8x4 Rigid, Tipper 32 T	F	01/98–01/01	Knorr			ACV041	29106	WL009	K005/ K018
	R	01/98–01/01	Knorr			ACV041	29106	WL009	K005/ K018
<b>CF Series</b> FAS85CF.340, FAS85CF.380, FAS85CF.430 6x2 Drawbar 26 T	F	01/98–01/01	Knorr			ACV041	29106	WL009	K005/ K018
	R	01/98–01/01	Knorr			ACV041	29106	WL009	K005/ K018
<b>CF Series</b> FT85CF.340, FT85CF.380, FT85CF.430 4x2 Tractor	F	01/98–01/01	Knorr			ACV041	29106	WL009	K005/ K018
	R	01/98–01/01	Knorr			ACV041	29106	WL009	K005/ K018
<b>CF Series</b> FTG85CF.340, FTG85CF.380, FTG85CF.430 6x2 Twin steer Tractor	F	01/98–01/01	Knorr			ACV041	29106	WL009	K005/ K018 –cont.

Where more than one part number is shown, use illustrations to determine correct pad fitment for the application



# Application Data

## Brake Pads, Wear Leads and Fitting Kits

# ANL Braking

<b>DAF – cont.</b> CF Series – cont.	R	01/98–01/01	Knorr			<b>ACV041</b>	29106	<b>WL009</b>	<b>K005/ K018</b>
<b>F Series</b> FA 600, FA 800	F	01/87–01/93	Wabco / Perrot		315	<b>ACV001</b>	29017		
	F	01/87–01/93	Wabco / Perrot		315	<b>ACV003</b>	29024		
<b>F Series</b> FA 1000, FA 1005	F	01/87–01/93	Wabco / Perrot		315	<b>ACV001</b>	29017		
	F	01/87–01/93	Wabco / Perrot		315	<b>ACV003</b>	29024		
<b>LF Series</b> LF45 17.5" wheels PAN 17	F	01/01→	Wabco / Perrot		312	<b>ACV039</b>	29088	<b>WL013</b>	<b>K006</b>
	F	01/01→	Wabco / Perrot		312	<b>ACV040</b>	29091	<b>WL013</b>	<b>K006</b>
	R	01/01→	Wabco / Perrot		312	<b>ACV039</b>	29088	<b>WL013</b>	<b>K006</b>
	R	01/01→	Wabco / Perrot		312	<b>ACV040</b>	29091	<b>WL013</b>	<b>K006</b>
<b>LF Series</b> LF55 19.5" wheels PAN 19-2	F	01/02→	Wabco / Perrot			<b>ACV059</b>	29141	<b>WL017</b>	<b>K015</b>
	R	01/02→	Wabco / Perrot			<b>ACV059</b>	29141	<b>WL017</b>	<b>K015</b>
<b>LF Series</b> LF55 22.5" wheels SB 7000	F	01/02→	Knorr		430	<b>ACV041</b>	29106	<b>WL009</b>	<b>K005/ K018</b>
	R	01/02→	Knorr		430	<b>ACV041</b>	29106	<b>WL009</b>	<b>K005/ K018</b>
<b>LF Series</b> LF55 22.5" wheels PAN 22	F	01/02→	Wabco / Perrot		430	<b>ACV049</b>	29146		<b>K009</b>
	R	01/02→	Wabco / Perrot		430	<b>ACV049</b>	29146		<b>K009</b>
<b>PSV Futura (Bova)</b>	F	01/82–01/86	Knorr		460	<b>ACV006</b>	29747		<b>K001</b>
<b>PSV Futura (Bova)</b> FHD, FVD Twin axle models SB 6000  SB 7000	F	01/87–01/95	Knorr		406	<b>ACV006</b>	29747		<b>K001</b>
	F	01/96→	Knorr		400	<b>ACV036</b>	29093	<b>WL015</b>	<b>K005/ K018</b>
	F	01/92→	Knorr		430	<b>ACV041</b>	29106	<b>WL009</b>	<b>K005/ K018</b>
	F	01/95→	Knorr		460	<b>ACV041</b>	29106	<b>WL009</b>	<b>K005/ K018</b>

Where more than one part number is shown, use illustrations to determine correct pad fitment for the application



# Application Data

## Brake Pads, Wear Leads and Fitting Kits

## ANL Braking

 	 	 		 mm	 ACV/ADB	 WVA NO.	 WL	 K	
<b>DAF – cont.</b> PSV Futura (Bova) FHD 15.430, FHX 15.420, FLD 15.370 Triple axle models non ABS  ABS   non ABS  ABS	F	01/92→	Knorr		430	ACV041	29106	WL009	K005/ K018
	F	01/95→	Knorr		430	ACV041	29106	WL009	K005/ K018
	F	01/95→	Knorr		460	ACV041	29106	WL009	K005/ K018
	R	01/92→	Knorr		430	ACV041	29106	WL009	K005/ K018
	R	01/95→	Knorr		430	ACV041	29106	WL009	K005/ K018
	R	01/95→	Knorr		460	ACV041	29106	WL009	K005/ K018
<b>PSV MB230 LB, LT</b>	F	01/87→	Knorr		460	ACV006	29747		K001
<b>PSV SB200</b>	F	01/02→	Knorr			ACV036	29093	WL015	K005/ K018
	R	01/02→	Knorr			ACV036	29093	WL015	K005/ K018
<b>PSV SB2300</b> DHS, DHTD	F	01/82–01/86	Knorr		460	ACV006	29747		K001
<b>PSV SB2300 DHTD</b>	F	01/87→	Knorr		460	ACV006	29747		K001
<b>PSV SB2305 DHS, DHTD</b>	F	01/87→	Knorr		460	ACV006	29747		K001
<b>PSV SB2705 DHS, DHTD</b>	F	01/87→	Knorr		460	ACV006	29747		K001
<b>PSV SB3000</b> DKSB	F	01/85–01/86	Knorr		460	ACV006	29747		K001
<b>PSV SB3000 DKSB, DKV, DKZ, DSKB</b>	F	01/87→	Knorr		460	ACV006	29747		K001
<b>PSV SBR 3000, DKSB, DKZ</b>	F	01/87→	Knorr		460	ACV006	29747		K001
<b>PSV Swift</b>	F	01/87–01/91	Wabco / Perrot			ACV001	29017		
	F	01/87–01/91	Wabco / Perrot			ACV003	29024		
	F	01/91→	Knorr				29688		
<b>Roadrunner</b> 6.10, 6.12, 6.13, 6.15	F	01/86–01/91	Wabco / Perrot		315	ACV001	29017		
	F	01/86–01/91	Wabco / Perrot		315	ACV003	29024		
<b>Roadrunner</b> 8.10, 8.12, 8.13, 8.15	F	01/86–01/91	Wabco / Perrot		315	ACV001	29017		
	F	01/86–01/91	Wabco / Perrot		315	ACV003	29024		

Where more than one part number is shown, use illustrations to determine correct pad fitment for the application



# Application Data

## Brake Pads, Wear Leads and Fitting Kits

# ANL Braking

<b>DAF – cont.</b> Roadrunner 10.12, 10.13, 10.15			F 01/86–01/91 F 01/86–01/91	Wabco / Perrot Wabco / Perrot	312 312	ACV001 ACV003	29017 29024		
<b>ACV001</b>									
191.0 × 87.0 × 23									
<b>ACV003</b>									
191.0 × 87.0 × 23									
<b>ACV006</b>									
140.0 × 121.0 × 32									
<b>ACV027</b>									
205.0 × 106.0 × 27									
<b>ACV036</b>									
210.7 × 92.5 × 30									
<b>ACV039</b>									
175.6 × 85.6 × 26									
<b>ACV040</b>									
175.6 × 85.6 × 27									
<b>ACV041</b>									
248.0 × 108.0 × 30									
<b>ACV049</b>									
247 × 107 × 30									
<b>ACV059</b>									
204.6 × 99.6 × 30									
<b>DAIHATSU</b>									
<b>55 Wide Van, Pick-Up</b> S65 (547cc)			F 01/81–07/86	Akebono	211	ADB0770	20780		
<b>55 Wide Van, Pick-Up</b> S70 (843cc)			F 01/81–07/86	Akebono	211	ADB0770	20780		
<b>Cab 1000</b> S75 (993cc) except 4x4 4x4			F 11/83–05/87 F 01/86→	Akebono Akebono	211 211	ADB0770 ADB0770	20780 20780		
			R 11/83→						
<b>Charade Van</b> 1.3i (G200)			F 01/93→		234	ADB3457	21952		
<b>Fieldman Pick-Up, Van</b> 2.8 Diesel, Turbo Diesel			F 08/93→ F 08/93→	Akebono Akebono	277 277	ADB3439 ADB3439	21967 21967		
<b>Hi-Jet</b> S84 (843cc)			F 07/86–04/89	Akebono	211	ADB0770	20780		
<b>Hi-Jet</b> S85 1.0, 1.2			F 12/92→	Akebono		ADB0770	20780		
<b>Hi-Jet</b> S86 1.0 4x4			F 07/86–12/92	Akebono	212	ADB0770	20780		
Where more than one part number is shown, use illustrations to determine correct pad fitment for the application									





# Application Data

## Brake Pads, Wear Leads and Fitting Kits

# ANL

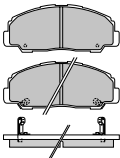
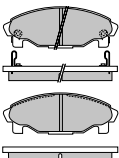
## Braking

<b>DAIHATSU – cont.</b>										
Porter										
	F	01/93→	Akebono		210	ADB0770	20780			
	R	01/93→								
<div style="display: flex; justify-content: space-around;"> <div style="text-align: center;"> <p><b>ADB0770</b></p>  <p>78.0 × 62.0 × 13.5</p> </div> <div style="text-align: center;"> <p><b>ADB3439</b></p>  <p>128.0 × 52.0 × 14</p> </div> <div style="text-align: center;"> <p><b>ADB3457</b></p>  <p>125.7 × 45.3 × 16</p> </div> </div>										
<b>DEN OUDSTEN</b>										
PSV Almere City Bus										
DX225 Axle 22.5" wheels										
	F	01/99→	Meritor (Lucas)		434	ACV057	29150			<b>K007</b>
<p><b>ACV057</b></p>  <p>245 × 120 × 30</p>										
<b>DENNIS (Transbus International Dennis)</b>										
<b>Dagger</b>										
<b>Fire Engines</b>										
Rapier										
	F	01/91→	S.E.E.		354	ACV009	29013			
<b>Fire Engines</b>										
Sabre										
	F	01/95→	Meritor (Lucas)			ACV029	29090	WL002		K003/ K017
<b>PSV Arrow</b>										
	F	01/95→	Meritor (Lucas)			ACV029	29090	WL002		K003/ K017
<b>PSV Dart</b>										
19.5" wheels PAN 19-2										
	F	01/02→	Wabco / Perrot			ACV059	29141	WL019		K015
	R	01/02→	Wabco / Perrot			ACV059	29141	WL019		K015
<b>PSV Enviro 300</b>										
	F									-cont.

Where more than one part number is shown, use illustrations to determine correct pad fitment for the application



# Application Data

## Brake Pads, Wear Leads and Fitting Kits

# ANL Braking

						ACV/ADB	WVA NO.	WL	K															
<b>DENNIS – cont.</b> PSV Enviro 300 – cont.	R																							
PSV Javelin Mk II	F 01/91→	Meritor (Lucas)		440				WL022/ WL023/ WL024																
	F 01/91→	Meritor (Lucas)		440	ACV015	29043	WL022/ WL023/ WL024																	
PSV Javelin Mk III	F 01/91→	Meritor (Lucas)		440	ACV015	29043	WL022/ WL023/ WL024																	
PSV Lance SLF	F 01/95→	Meritor (Lucas)			ACV014 <sup>①</sup>	29030			K002/ K016															
	F 01/95→	Meritor (Lucas)			ACV030 <sup>②</sup>	29053	WL003		K013/ K016															
Note: Disc Th 45→41mm use <sup>①</sup> , 41→38mm use <sup>②</sup>																								
PSV R Series 22.5" wheels	F 01/01→	Knorr		430	ACV041	29106			K005/ K018															
	R 01/01→	Knorr		430	ACV041	29106			K005/ K018															
PSV Trident II 22.5" wheels	F 01/01→	Knorr		430	ACV041	29106			K005/ K018															
	R 01/01→	Knorr		430	ACV041	29106			K005/ K018															
<table border="0" style="width:100%; text-align:center;"> <tr> <td><b>ACV009</b></td> <td><b>ACV014</b></td> <td><b>ACV015</b></td> <td><b>ACV029</b></td> <td><b>ACV030</b></td> </tr> <tr> <td></td> <td></td> <td></td> <td></td> <td></td> </tr> <tr> <td>180.0 × 86.0 × 21.5</td> <td>250.0 × 118.0 × 28</td> <td>204.0 × 96.0 × 24</td> <td>250.0 × 114.0 × 28</td> <td>250.0 × 118.0 × 28</td> </tr> </table>										<b>ACV009</b>	<b>ACV014</b>	<b>ACV015</b>	<b>ACV029</b>	<b>ACV030</b>						180.0 × 86.0 × 21.5	250.0 × 118.0 × 28	204.0 × 96.0 × 24	250.0 × 114.0 × 28	250.0 × 118.0 × 28
<b>ACV009</b>	<b>ACV014</b>	<b>ACV015</b>	<b>ACV029</b>	<b>ACV030</b>																				
180.0 × 86.0 × 21.5	250.0 × 118.0 × 28	204.0 × 96.0 × 24	250.0 × 114.0 × 28	250.0 × 118.0 × 28																				
<table border="0" style="width:100%; text-align:center;"> <tr> <td><b>ACV041</b></td> <td><b>ACV059</b></td> </tr> <tr> <td></td> <td></td> </tr> <tr> <td>248.0 × 108.0 × 30</td> <td>204.6 × 99.6 × 30</td> </tr> </table>										<b>ACV041</b>	<b>ACV059</b>			248.0 × 108.0 × 30	204.6 × 99.6 × 30									
<b>ACV041</b>	<b>ACV059</b>																							
248.0 × 108.0 × 30	204.6 × 99.6 × 30																							
Where more than one part number is shown, use illustrations to determine correct pad fitment for the application																								





# Application Data

## Brake Pads, Wear Leads and Fitting Kits

# ANL Braking

<b>DISCOS</b>									
<b>Trailers</b> with Haldex brakes DB 20 22.5" wheels									
			01/00→	Haldex		430	<b>ACV054</b>	29143	<b>K012</b>
<b>Trailers</b> with Knorr Brakes 17.5" wheels SB 5000			01/99→	Knorr			<b>ACV038</b>	29115	<b>K005/ K018</b>
19.5" wheels SB 6000			01/99→	Knorr			<b>ACV043</b>	29095	<b>WL015</b> <b>K005/ K018</b>
22.5" wheels SB 7000			01/99→	Knorr		430	<b>ACV042</b>	29108	<b>K005/ K018</b>
<b>Trailers</b> NR Series SB 7000 22.5" wheels			01/99→	Knorr		430	<b>ACV042</b>	29108	<b>K005/ K018</b>
<b>Trailers</b> TZ Series 17.5" wheels SB 5000			01/99→	Knorr			<b>ACV038</b>	29115	<b>K005/ K018</b>
19.5" wheels SB 6000			01/99→	Knorr			<b>ACV043</b>	29095	<b>WL015</b> <b>K005/ K018</b>
22.5" wheels SB 7000			01/99→	Knorr		430	<b>ACV042</b>	29108	<b>K005/ K018</b>
<b>Trailers</b> with Wabco Brakes PAN 19-1 19.5" wheels			01/00→	Wabco / Perrot		377	<b>ACV048</b>	29126	<b>K008</b>
PAN 22 22.5" wheels			01/00→	Wabco / Perrot		430	<b>ACV049</b>	29146	<b>K009</b>

**ACV038**

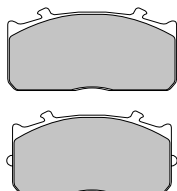

173.6 × 84 × 34.00/27.00

**ACV042**

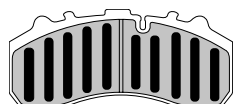

248.0 × 108.0 × 30

**ACV043**

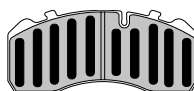

210.7 × 92.5 × 30

**ACV048**



210 × 93 × 30

**ACV049**

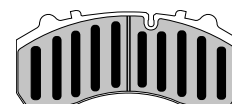

247 × 107 × 30

Where more than one part number is shown, use illustrations to determine correct pad fitment for the application



# Application Data

## Brake Pads, Wear Leads and Fitting Kits

# ANL

## Braking



WL

K

### DISCOS – cont.

ACV054

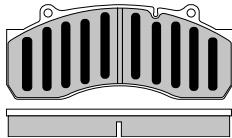

248 × 105 × 30

### ERF

#### ECM Series

22.5" wheels  
D3 caliper

F

11/99→

Meritor (Lucas)



ACV014<sup>①</sup>

29030

WL003

K002/

K016

F

11/99→

Meritor (Lucas)



ACV030<sup>②</sup>

29053

WL003

K013/

K016

F

11/99→

Meritor (Lucas)



ACV058

29131

K002

Note: Disc Th 45→41mm use <sup>①</sup>, 41→38mm use <sup>②</sup>

#### ECS Series

22.5" wheels  
D3 caliper

F

11/99→

Meritor (Lucas)



ACV014<sup>①</sup>

29030

WL003

K002/

K016

F

11/99→

Meritor (Lucas)



ACV030<sup>②</sup>

29053

WL003

K013/

K016

D Elsa 2 caliper

F

11/99→

Meritor (Lucas)



ACV058

29131

K002

D3 caliper

R

11/99→

Meritor (Lucas)



ACV014<sup>①</sup>

29030

WL003

K002/

K016

R

11/99→

Meritor (Lucas)



ACV030<sup>②</sup>

29053

WL003

K013/

K016

D Elsa 2 caliper

R

11/99→

Meritor (Lucas)



ACV058

29131

K002

Note: Disc Th 45→41mm use <sup>①</sup>, 41→38mm use <sup>②</sup>

#### ECT Series

22.5" wheels  
D3 caliper

F

11/99→

Meritor (Lucas)



ACV014<sup>①</sup>

29030

WL003

K002/

K016

F

11/99→

Meritor (Lucas)



ACV030<sup>②</sup>

29053

WL003

K013/

K016

D Elsa 2 caliper

F

11/99→

Meritor (Lucas)



ACV058

29131

K002

D3 caliper

R

11/99→

Meritor (Lucas)



ACV014<sup>①</sup>

29030

WL003

K002/

K016

R

11/99→

Meritor (Lucas)



ACV030<sup>②</sup>

29053

WL003

K013/

K016

D Elsa 2 caliper

R

11/99→

Meritor (Lucas)



ACV058

29131

K002

Note: Disc Th 45→41mm use <sup>①</sup>, 41→38mm use <sup>②</sup>

#### ECX Series

22.5" wheels  
D3 caliper

F

11/99→

Meritor (Lucas)



ACV014<sup>①</sup>

29030

WL003

K002/

K016

F

11/99→

Meritor (Lucas)



ACV030<sup>②</sup>

29053

WL003

K013/

K016

D Elsa 2 caliper

F

11/99→

Meritor (Lucas)



ACV058

29131

K002

-cont.

Where more than one part number is shown, use illustrations to determine correct pad fitment for the application



# Application Data

## Brake Pads, Wear Leads and Fitting Kits

# ANL

## Braking

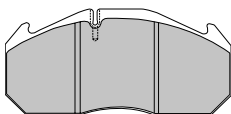
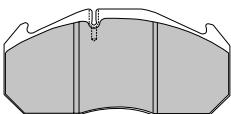
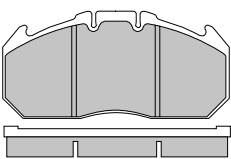
						ACV/ADB	WVA NO.	WL	K
<b>ERF – cont.</b> <b>ECX Series – cont.</b> D3 caliper  D Elsa 2 caliper <b>Note: Disc Th 45→41mm use ①, 41→38mm use ②</b>	R	11/99→	Meritor (Lucas)			<b>ACV014</b> ①	29030	<b>WL003</b>	<b>K002/</b> <b>K016</b>
	R	11/99→	Meritor (Lucas)			<b>ACV030</b> ②	29053	<b>WL003</b>	<b>K013/</b> <b>K016</b>
	R	11/99→	Meritor (Lucas)			<b>ACV058</b>	29131		<b>K002</b>
<div style="display: flex; justify-content: space-around; text-align: center;"> <div> <p><b>ACV014</b></p>  <p>250.0 × 118.0 × 28</p> </div> <div> <p><b>ACV030</b></p>  <p>250.0 × 118.0 × 28</p> </div> <div> <p><b>ACV058</b></p>  <p>250.0 × 118.0 × 30</p> </div> </div>									
<b>EVOBUS</b> see MERCEDES PSV's									
<b>FIAT</b>									
<b>242 Van</b>   Handbrake pads	F	01/74–01/86	Citroen		285				
	F	01/74–01/86	Citroen		285				
	R	01/74–01/86	Citroen		279				
	R	01/74–01/86	Citroen		279				
	R	01/74–01/86	Citroen						
<b>900T Van</b>	F	01/80–01/82	Bendix		227	<b>ADB0112</b>	20073		
	F	01/82–01/84	Bendix		227	<b>ADB0129</b>	20950		
	F	01/82–01/84	Bendix		227	<b>ADB4129</b>	20950		
<b>Citivan / Penny</b> 1.1 Petrol, 1.7 Diesel	F	01/88→	Ate		240	<b>ADB0228</b>	21193		
	F	01/88→	Ate		240	<b>ADB1228</b>	21195		
<b>Daily See IVECO</b>									
<b>Doblo</b> 1.2i	F	02/01→	Ate		257	<b>ADB0201</b>	23552		
<b>Doblo</b> 1.9 D, 1.9 JTD	F	02/01→	Ate		257	<b>ADB0201</b>	23552		
<b>Ducato →94</b> except Maxi →VIN 4461 VIN 4462→ →VIN 4461 VIN 4462→	F	01/81–06/84	Brembo		256	<b>ADB11047</b>	21049		
	F	06/84–01/94	Brembo		256	<b>ADB11047</b>	21049		
	F	01/81–06/84	Lucas		256	<b>ADB1254</b>	20741		
	F	06/84–01/94	Lucas		256		21205		
<b>Ducato →94</b> Maxi 1.8 Ton	F	01/86–01/94	Brembo		290	<b>ADB11047</b>	21049		
	F	01/86–01/94	Lucas		290		21205		

Where more than one part number is shown, use illustrations to determine correct pad fitment for the application



# Application Data

## Brake Pads, Wear Leads and Fitting Kits

# ANL

## Braking

						ACV/ADB	WVA	WL	K
						mm	NO.		
<b>FIAT – cont.</b> <b>Ducato 94→01/02</b> 1.0 Tonne 1.9 D, 1.9 TD, 2.0i, 2.5 D, 2.5 TD	F	02/94–09/99	Lucas		280	<b>ADB2219</b>	21627		
	F	02/94–09/99	Lucas		280	<b>ADB2219</b>	21627		
	F	09/99–09/01	Lucas		280	<b>ADB11031</b>	23602		
	F	09/99–09/01	Lucas		280	<b>ADB11031</b>	23602		
<b>Ducato 94→01/02</b> 1.4 Tonne 1.9 D, 1.9 TD, 2.0i, 2.5 D, 2.5 TD	F	02/94–09/99	Lucas		280	<b>ADB2219</b>	21627		
	F	02/94–09/99	Lucas		280	<b>ADB2219</b>	21627		
	F	09/99–09/01	Lucas		280	<b>ADB11031</b>	23602		
	F	09/99–09/01	Lucas		280	<b>ADB11031</b>	23602		
<b>Ducato 94→01/02</b> 1.8 Tonne 2.0i non ABS ABS non ABS ABS 2.5 D, 2.5 TD non ABS ABS non ABS ABS	F	02/94–09/99	Lucas		300	<b>ADB1275</b>	21629		
	F	02/94–09/99	Lucas		300	<b>ADB1275</b>	21629		
	F	09/99–09/01	Lucas		300	<b>ADB11032</b>	23603		
	F	09/99–09/01	Lucas		300	<b>ADB11032</b>	23603		
	F	02/94–09/99	Lucas		300	<b>ADB1275</b>	21629		
	F	02/94–09/99	Lucas		300	<b>ADB1275</b>	21629		
	F	09/99–09/01	Lucas		300	<b>ADB11032</b>	23603		
	F	09/99–09/01	Lucas		300	<b>ADB11032</b>	23603		
<b>Ducato 01/02→</b> 11	F	09/01→	Brembo		280	<b>ADB11040</b>	23602		
	R	09/01→	Brembo		280	<b>ADB01042</b>			
<b>Ducato 01/02→</b> 15	F	09/01→	Brembo		280	<b>ADB11040</b>	23602		
	R	09/01→	Brembo		280	<b>ADB01042</b>			
<b>Ducato 01/02→</b> 18	F	09/01→	Brembo		300	<b>ADB11041</b>	23603		
	R	09/01→	Brembo		280	<b>ADB01042</b>			
<b>Fiorino Van</b>	F	01/88–01/97	Ate		240	<b>ADB0228</b>	21193		
	F	01/88–01/97	Ate		240	<b>ADB1228</b>	21195		
	F	01/78–06/88	Bendix		227	<b>ADB0112</b>	20073		
<b>Panda Van</b>	F	01/86–01/93	Bendix		227	<b>ADB0129</b>	20950		
	F	01/86–01/93	Bendix		227	<b>ADB4129</b>	20950		
	F	01/93–07/95	Lucas		227	<b>ADB4137</b>	20833		
<b>Punto Van</b> 1.7 Turbo Diesel	F	01/96–09/99	Ate		257	<b>ADB0479</b>	21930		
	F	01/96–09/99	Ate		257	<b>ADB1479</b>	21930		
	F	01/96–09/99	Lucas		257	<b>ADB4137</b>	20833		
<b>Punto II Van</b> 1.2i	F	09/99→	Ate		257	<b>ADB01018</b>	23181		

Where more than one part number is shown, use illustrations to determine correct pad fitment for the application



# Application Data

## Brake Pads, Wear Leads and Fitting Kits

# ANL Braking

<b>FIAT – cont.</b> Punto II Van 1.9 JTD			F R								
			F	09/99→	Ate		257	<b>ADB01018</b>	23181		
			F	09/99→	Ate		257	<b>ADB0201</b>	23552		
<b>Scudo</b> 1.6i			F R								
			F	01/96→	Bendix		257	<b>ADB2714</b>	23003		
			F	01/96→	Lucas		281	<b>ADB11001</b>	21801		
<b>Scudo</b> 1.9 D, 1.9 TD			F R								
			F	01/96→	Bendix		257	<b>ADB2714</b>	23003		
			F	01/96→	Lucas		281	<b>ADB11001</b>	21801		
<b>Scudo</b> 2.0 JTD			F R								
			F	09/99→	Bendix		257	<b>ADB2714</b>	23003		
			F	09/99→	Lucas		281	<b>ADB11001</b>	21801		
<b>Scudo</b> 2.0i			F R								
			F	09/99→	Bendix		257	<b>ADB2714</b>	23003		
			F	09/99→	Lucas		281	<b>ADB11001</b>	21801		
<b>Talento</b> 1.9 D, 1.9 TD, 2.0i, 2.5 D, 2.5 TD			F	01/89–12/93	Lucas		256	<b>ADB1254</b>	20741		
<b>Uno Van</b> 1.0 Petrol, 1.7 Diesel			F R								
			F	01/83–01/96	Bendix		227	<b>ADB0129</b>	20950		
			F	01/83–01/96	Bendix		227	<b>ADB4129</b>	20950		
			F	01/83–01/96	Lucas		227	<b>ADB4137</b>	20833		
<b>ADB0112</b>	<b>ADB0129</b>	<b>ADB0201</b>	<b>ADB0228</b>	<b>ADB0479</b>							
108.9 × 39.0 × 17.5	108.9 × 48.0 × 18	151.4 × 52.5 × 18	151.4 × 49.5 × 18	151.3 × 52.0 × 17.4							
<b>ADB01018</b>	<b>ADB01042</b>	<b>ADB1228</b>	<b>ADB1254</b>	<b>ADB1275</b>							
151.3 × 52.0 × 17.4	110 × 50 × 20	151.4 × 49.5 × 18	130.0 × 71.5 × 19	160.0 × 65.0 × 19							

Where more than one part number is shown, use illustrations to determine correct pad fitment for the application



# Application Data

## Brake Pads, Wear Leads and Fitting Kits

# ANL Braking



mm



WVA NO.

WL

K

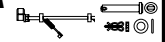

### FIAT – cont.

**ADB1479**

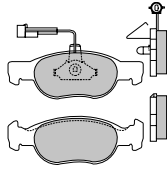

151.3 × 52.0 × 17.4

**ADB2219**

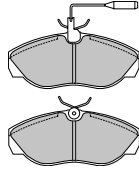

145.0 × 62.0 × 19

**ADB2714**

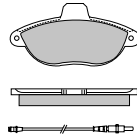

140 × 69 × 18.3

**ADB4129**

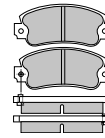

108.9 × 48.0 × 18

**ADB4137**

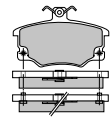

106.0 × 67.0 × 17

**ADB11001**

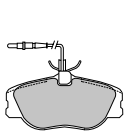

130.0 × 60.0 × 18

**ADB11031**

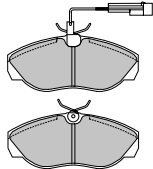

145.0 × 62.0 × 19

**ADB11032**

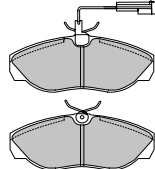

160.0 × 65.0 × 19

**ADB11040**

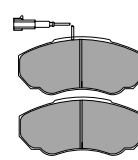

141 × 66 × 19

**ADB11041**

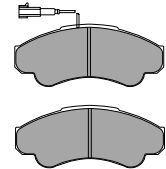

165 × 70 × 19

**ADB11047**

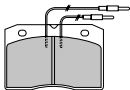

109.7 × 73.0 × 18.3

### FORD

Courier - see Fiesta Van / Courier

Escort Mkl Van  
1.1, 1.3

F

01/68–01/75

Lucas



218

**ADB0389**

20088

Escort MkII Van  
30 / 35

F

01/75–01/80

Ate



247

**ADB0156**

20491

Escort MkII Van  
45

F

01/75–01/80

Ate



247

**ADB0156**

20491

Escort III / Escort 86 Van

F

01/80–01/90

Ate



239

**ADB0118**

20753

F

01/80–01/90

Ate



239

**ADB0118**

20753

F

01/80–01/90

Ate



239

**ADB0118**

20753

F

01/80–01/90

Ate



239

**ADB0118**

20753

Escort 90 Van (MkV–MkVII)  
1.3, 1.4

F

01/90–10/96

Bendix



239

**ADB0393**

21171

F

01/90–10/96

Bendix



239

**ADB0393**

21171

F

10/96–10/98

Bendix



239

**ADB3393**

23300

F

10/96–10/98

Bendix



239

**ADB3393**

23300

Where more than one part number is shown, use illustrations to determine correct pad fitment for the application



# Application Data

## Brake Pads, Wear Leads and Fitting Kits

# ANL

## Braking

						ACV/ADB	WVA NO.	WL	K
<b>FORD – cont.</b> Escort 90 Van (MkV–MkVII) 1.8 Diesel, Turbo Diesel	F	01/90–10/96	Bendix		239	<b>ADB0393</b>	21171		
	F	01/90–10/96	Bendix		239	<b>ADB0393</b>	21171		
	F	10/96–10/98	Bendix		239	<b>ADB3393</b>	23300		
	F	10/96–10/98	Bendix		239	<b>ADB3393</b>	23300		
<b>Fiesta Van (→89)</b> 950, 1.1, 1.3, 1.4, 1.6D, 1.8D	F	01/77–01/83	Bendix		221	<b>ADB0567</b>	20422		
	F	01/83–01/89	Ate		221	<b>ADB0397</b>	20857		
<b>Fiesta Van / Courier (89→95)</b> 1.0, 1.1, 1.3, 1.4, 1.6D, 1.8D non ABS ABS	F	04/89–01/95	Ate		239	<b>ADB0502</b>	21202		
	F	04/89–01/95	Ate		239	<b>ADB0118</b>	20753		
<b>Fiesta Van / Courier (95→00)</b> 1.25i 16V	F	01/95–02/00	Ate		239.7	<b>ADB0876</b>	23102		
	F	01/95–02/00	Ate		239	<b>ADB0444</b>	23104		
<b>Fiesta Van / Courier (95→00)</b> 1.3i, 1.4i	F	01/95–02/00	Ate		239.7	<b>ADB0876</b>	23102		
	F	01/95–02/00	Ate		239	<b>ADB0444</b>	23104		
<b>Fiesta Van / Courier (95→00)</b> 1.8 Diesel	F	01/95–02/00	Ate		239.7	<b>ADB0876</b>	23102		
	F	01/95–02/00	Ate		239	<b>ADB0444</b>	23104		
<b>Fiesta Van / Courier (00→)</b> 1.3i, 1.4i non ABS ABS	F	02/00→	Ate		240	<b>ADB0899</b>	23200		
	F	02/00→	Ate		258	<b>ADB0891</b>	23202		
<b>Fiesta Van / Courier (00→)</b> 1.8 TDi non ABS ABS	F	02/00→	Ate		240	<b>ADB0899</b>	23200		
	F	02/00→	Ate		258	<b>ADB0891</b>	23202		
<b>Maverick Van</b> 2.4i, 2.7i, 2.7 Turbo Diesel	F	06/93→	Lucas		277	<b>ADB0447</b>	21481		
	F	06/93→	Sumitomo		277	<b>ADB0423</b>	21347		
	F	06/93→	Sumitomo		277	<b>ADB3863</b>	21348		
<b>P100</b> Cortina based	F	01/82–01/88	Ate				20578		
<b>P100</b> Sierra based	F	01/88–01/94	Ate		240	<b>ADB0118</b>	20753		
	F	01/88–01/94	Ate		240	<b>ADB0118</b>	20753		
	F	01/88–01/94	Bendix		240	<b>ADB0390</b>	21141		
<b>Ranger</b> 2.5 D, 2.5 TD	F	05/99→				<b>ADB31014</b>	23472		
<b>Transit 76→86</b> 80→190 2 x 57mm caliper pistons 4 x 41mm caliper pistons	F	01/76–01/86	Lockheed		270	<b>ADB0239</b>	20364		
	F	01/76–01/86	Lockheed		270	<b>ADB0319</b>	20359		
	F	01/76–01/86	Lockheed		270	<b>ADB0319</b>	20359		

Where more than one part number is shown, use illustrations to determine correct pad fitment for the application



# Application Data

## Brake Pads, Wear Leads and Fitting Kits

# ANL Braking

 	 	 	 	 	 	<b>ACV/ADB</b>  <b>WVA NO.</b>	<b>WL</b> 	<b>K</b> 	
<b>FORD – cont.</b> <b>Transit 86→91</b> 80→120 models except 100L  100L with 4x41mm caliper pistons with 4x46mm caliper pistons	F	01/86–01/91	Bendix		254	<b>ADB0390</b>	21141		
	F	01/86–01/91	Bendix		254	<b>ADB0390</b>	21141		
	F	01/86–01/91	Lockheed		270	<b>ADB0319</b>	20359		
	F	01/86–01/91	Lockheed		270	<b>ADB01066</b>	20904		
<b>Transit 86→91</b> 130→190 models 2 x 57mm caliper pistons with 4x41mm caliper pistons with 4x46mm caliper pistons	F	01/86–01/91	Lockheed		270	<b>ADB0239</b>	20364		
	F	01/86–01/91	Lockheed		270	<b>ADB0319</b>	20359		
	F	01/86–01/91	Lockheed		270	<b>ADB01066</b>	20904		
<b>Transit 91→2000</b> 80→120 models (inc Tourneo) 14" wheels  15" wheels	F	01/91–01/95	Bendix		254	<b>ADB0132</b>	21470		
	F	01/95–10/00	Bendix		254	<b>ADB0132</b>	21470		
	F	01/98–10/00	Bendix		254	<b>ADB3887</b>	21470		
	F	01/91–01/95	Bendix		270	<b>ADB0924</b>	21469		
	F	01/95–10/00	Bendix		270	<b>ADB0924</b>	21469		
	F	01/98–10/00	Bendix		270	<b>ADB3924</b>	21469		
<b>Transit 91→2000</b> 130→230 models (inc Tourneo) 15" wheels	F	01/91–01/95	Bendix		270	<b>ADB0924</b>	21469		
	F	01/95–10/00	Bendix		270	<b>ADB0924</b>	21469		
	F	01/98–10/00	Bendix		270	<b>ADB3924</b>	21469		
<b>Transit 2000→</b> 260 FWD	F	04/00→	Bosch		294	<b>ADB31107</b>	23434		
<b>Transit 2000→</b> 280 FWD	F	04/00→	Bosch		294	<b>ADB31107</b>	23434		
<b>Transit 2000→</b> 300 FWD RWD	F	04/00→	Bosch		294	<b>ADB31107</b>	23434		
	F	04/00→	Bosch		294	<b>ADB31108</b>	23577		
<b>Transit 2000→</b> 330 RWD	F	04/00→	Bosch		294	<b>ADB31108</b>	23577		
<b>Transit 2000→</b> 350 RWD	F	04/00→	Bosch		294	<b>ADB31108</b>	23577		
<b>Transit 2000→</b> 425 RWD	F	04/00→	Bosch		294	<b>ADB31108</b>	23577		
<b>Transit Connect</b> T200, T210, T220, T230 1.8 TDi	F	08/02→	Ate		280	<b>ADB01150</b>	23440		
	R	08/02→	Ate		280	<b>ADB01153</b>	23440		

Where more than one part number is shown, use illustrations to determine correct pad fitment for the application





# Application Data

## Brake Pads, Wear Leads and Fitting Kits

# ANL Braking



WL

K

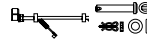

### FORD – cont.

**ADB0118**

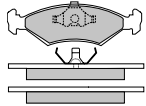

151.4 × 46.5 × 18

**ADB0132**

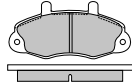

138.8 × 64.0 × 18

**ADB0156**



78.0 × 66.4 × 15

**ADB0239**



88.5 × 70.9 × 15

**ADB0319**



104.9 × 74.7 × 18

**ADB0389**



63.4 × 54.9 × 14

**ADB0390**

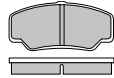

116.0 × 58.0 × 18

**ADB0393**

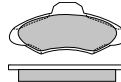

130.8 × 57.5 × 17.8

**ADB0397**

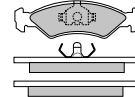

141.4 × 42.8 × 17.25

**ADB0423**

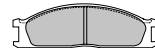

160.0 × 49.2 × 17

**ADB0444**

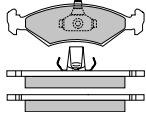

151.4 × 46.5 × 18

**ADB0447**

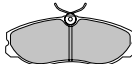

144.0 × 56.0 × 15.5

**ADB0502**

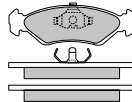

141.4 × 45.0 × 17.2

**ADB0567**

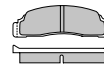

108.4 × 35.3 × 17.5

**ADB0876**

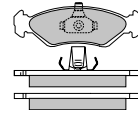

141.4 × 45.0 × 17.2

**ADB0891**

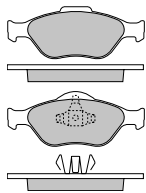

151.3/151.0 × 58.2/61.0 × 18.8

**ADB0899**

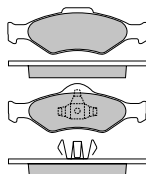

151.3/151.0 × 51.2/54.0 × 18.8

**ADB0924**

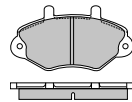

138.8 × 72.0 × 18

**ADB01066**

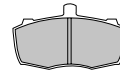

126.7 × 71.2 × 18

**ADB01150**

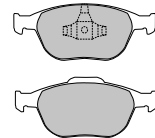

156 × 63 × 17.5

**ADB01153**

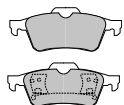

156 × 63 × 17.5

**ADB3393**

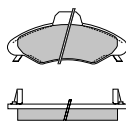

130.8 × 57.5 × 18.5

**ADB3863**

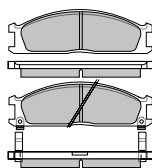

160.0 × 49.2 × 17

**ADB3887**

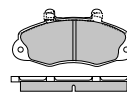

138.8 × 64.0 × 18

**ADB3924**

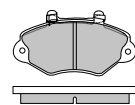

138.8 × 72.0 × 18

Where more than one part number is shown, use illustrations to determine correct pad fitment for the application



# Application Data

## Brake Pads, Wear Leads and Fitting Kits

# ANL Braking



WVA NO.

WL

K

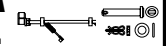

### FORD – cont.

ADB31014

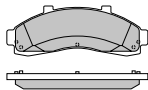

154 × 60 × 17.5

ADB31107

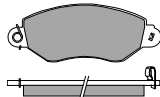

168 × 64 × 17

ADB31108

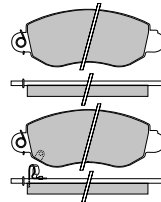

169 × 63.5 × 18

### FORD HGV

see IVECO

### FREIGHT ROVER

see L.D.V (LEYLAND DAF VANS)

### FRUEHAUF (Includes Crane Fruehauf, GT Trailers, SMB Axles)

with Haldex brakes DB 19	R	01/99→	Haldex			ACV053	29147		K012
with Haldex brakes DB 20	R	09/96→	Haldex		430	ACV054	29143		K012
with Knorr brakes SB 7000	R	01/98→	Knorr		430	ACV042	29108		K005/ K018 K005/ K018
	R	09/96→	Knorr		430	ACV042	29108		
with Wabco / Perrot brakes PAN 19-1	R	01/99→	Wabco / Perrot		377	ACV048	29126		K008
with Wabco / Perrot brakes PAN 22	R	01/98→	Wabco / Perrot		430	ACV049	29146		K009 K009
	R	01/98→	Wabco / Perrot		430	ACV049	29146		

ACV042

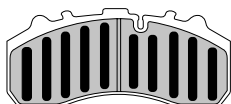

248.0 × 108.0 × 30

ACV048



210 × 93 × 30

ACV049

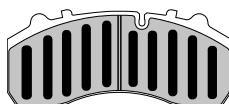

247 × 107 × 30

ACV053

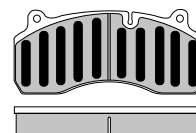

210.7 × 93.5 × 30

ACV054

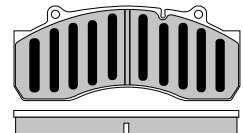

248 × 105 × 30

### FSO

125P Pick -Up  
1.3, 1.5

F	01/75–01/90	Bendix		227	ADB0112	20073		
R	01/75–01/90	Bendix		227	ADB0243	20074		

Where more than one part number is shown, use illustrations to determine correct pad fitment for the application



# Application Data

## Brake Pads, Wear Leads and Fitting Kits

# ANL Braking

						ACV/ADB	WVA NO.	WL	K																														
<b>FSO – cont.</b> Cargo Van 1.5, 1.9 D	F	09/94→	Lucas		227	<b>ADB0142</b>	21100																																
	F	09/94→	Lucas		227	<b>ADB1142</b>	21100																																
	R	09/94→	Bendix		227	<b>ADB0243</b>	20074																																
<b>Caro Pick-Up, Tipper</b> 1.5, 1.9 D	F	09/88→	Bendix		227	<b>ADB0112</b>	20073																																
	R	09/88→	Bendix		227	<b>ADB0243</b>	20074																																
<table border="0" style="width:100%; text-align:center;"> <tr> <td><b>ADB0112</b></td> <td><b>ADB0142</b></td> <td><b>ADB0243</b></td> <td><b>ADB1142</b></td> <td colspan="6"></td> </tr> <tr> <td></td> <td></td> <td></td> <td></td> <td colspan="6"></td> </tr> <tr> <td>108.9 × 39.0 × 17.5</td> <td>89.9 × 63.5 × 17</td> <td>108.9 × 39.0 × 10</td> <td>89.9 × 63.5 × 17</td> <td colspan="6"></td> </tr> </table>										<b>ADB0112</b>	<b>ADB0142</b>	<b>ADB0243</b>	<b>ADB1142</b>																	108.9 × 39.0 × 17.5	89.9 × 63.5 × 17	108.9 × 39.0 × 10	89.9 × 63.5 × 17						
<b>ADB0112</b>	<b>ADB0142</b>	<b>ADB0243</b>	<b>ADB1142</b>																																				
108.9 × 39.0 × 17.5	89.9 × 63.5 × 17	108.9 × 39.0 × 10	89.9 × 63.5 × 17																																				
<b>GRANNING LYNX</b>																																							
<b>SB 5000</b> 17.5" wheels		01/00→	Knorr			<b>ACV038</b>	29115		<b>K005/K018</b>																														
<b>SB 6000</b> 19.5" wheels		01/00→	Knorr			<b>ACV043</b> <sup>①</sup>	29095	<b>WL015</b>	<b>K005/K018</b>																														
		01/00→	Knorr		377	<b>ACV044</b> <sup>②</sup>	29095	<b>WL015</b>	<b>K005/K018</b>																														
<b>Note: Disc Th 45→41mm use ①, 41→38mm use ②</b>																																							
<b>SB 7000</b> 22.5" wheels		01/00→	Knorr			<b>ACV042</b>	29108		<b>K005/K018</b>																														
<table border="0" style="width:100%; text-align:center;"> <tr> <td><b>ACV038</b></td> <td><b>ACV042</b></td> <td><b>ACV043</b></td> <td><b>ACV044</b></td> <td colspan="6"></td> </tr> <tr> <td></td> <td></td> <td></td> <td></td> <td colspan="6"></td> </tr> <tr> <td>173.6 × 84 × 34.00/27.00</td> <td>248.0 × 108.0 × 30</td> <td>210.7 × 92.5 × 30</td> <td>210.7 × 92.5 × 30</td> <td colspan="6"></td> </tr> </table>										<b>ACV038</b>	<b>ACV042</b>	<b>ACV043</b>	<b>ACV044</b>																	173.6 × 84 × 34.00/27.00	248.0 × 108.0 × 30	210.7 × 92.5 × 30	210.7 × 92.5 × 30						
<b>ACV038</b>	<b>ACV042</b>	<b>ACV043</b>	<b>ACV044</b>																																				
173.6 × 84 × 34.00/27.00	248.0 × 108.0 × 30	210.7 × 92.5 × 30	210.7 × 92.5 × 30																																				
<b>GT TRAILERS</b> see FRUEHAUF																																							

Where more than one part number is shown, use illustrations to determine correct pad fitment for the application



















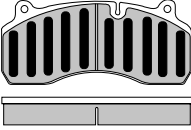
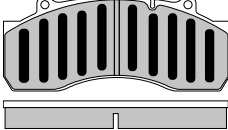

# Application Data

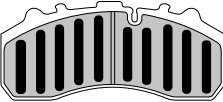
## Brake Pads, Wear Leads and Fitting Kits

# ANL

## Braking

									
<b>HALDEX BRAKES</b>									
19.5" wheels			01/99→	Haldex		ACV053	29147		K012
22.5" wheels			01/99→	Haldex		430 ACV054	29143		K012
<div style="display: flex; justify-content: space-around;"> <div style="text-align: center;"> <p>ACV053</p>  <p>210.7 × 93.5 × 30</p> </div> <div style="text-align: center;"> <p>ACV054</p>  <p>248 × 105 × 30</p> </div> </div>									
<b>HENDRICKSON</b>									
with Knorr brakes SB 7000			01/99→	Knorr		430 ACV042	29108		K005/ K018
<div style="text-align: center;"> <p>ACV042</p>  <p>248.0 × 108.0 × 30</p> </div>									
<b>HEULIEZ</b>									
GX217 with Volvo chassis	F			Meritor (Lucas)		ACV029	29090	WL001	K003/ K017
GX317 with Renault chassis	F	01/93→		Meritor (Lucas)		438 ACV014 <sup>①</sup>	29030	WL004	K002/ K016 K013/ K016
	F	01/93→		Meritor (Lucas)		438 ACV030 <sup>②</sup>	29053	WL004	
<b>Note: Disc Th 45→41mm use <sup>①</sup>, 41→38mm use <sup>②</sup></b>									
GX417 with Volvo chassis	F			Meritor (Lucas)		ACV029	29090	WL001	K003/ K017
GX917 with Volvo chassis	F			Meritor (Lucas)		ACV029	29090	WL001	K003/ K017

Where more than one part number is shown, use illustrations to determine correct pad fitment for the application



# Application Data

## Brake Pads, Wear Leads and Fitting Kits

# ANL Braking



WVA  
NO.

WL

K

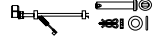

### HEULIEZ – cont.

ACV014

ACV029

ACV030

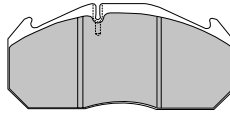
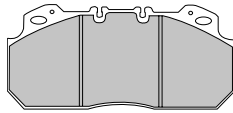
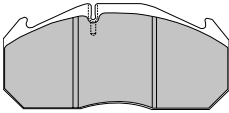

250.0 × 118.0 × 28

250.0 × 114.0 × 28

250.0 × 118.0 × 28

### HYUNDAI

<b>HD1000</b>	F	01/78–01/94	Sumitomo			<b>ADB0111</b>	20703		
<b>H Series</b> H100 2.4, 2.5	F	10/94→	Lucas		253	<b>ADB0225</b>	23083		
	F	10/94→	Lucas		253	<b>ADB3225</b>	23083		
<b>H Series</b> H150 2.5	F	10/94→	Lucas		253	<b>ADB0225</b>	23083		
	F	10/94→	Lucas		253	<b>ADB3225</b>	23083		
<b>H Series</b> H200 2.5	F	10/94–01/97	Lucas		253	<b>ADB0225</b>	23083		
	F	10/94–01/97	Lucas		253	<b>ADB3225</b>	23083		
	F	01/97→	Mando			<b>ADB3481</b>	23536		

ADB0111



78.7 × 60.0 × 14.5

ADB0225

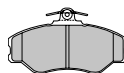

130.0 × 72.6 × 19

ADB3225

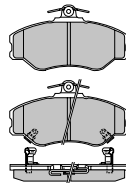

130.0 × 72.6 × 19.00

ADB3481

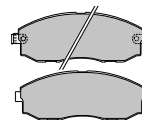

148 × 54 × 15.5

### INBUS

<b>F140</b>	F	01/88→	Wabco / Perrot		425				
<b>S210 - 1330</b>	F	01/88→	Wabco / Perrot		425				
<b>U210 - 1330</b>	F	01/88→	Wabco / Perrot		425				

### IRISBUS see IVECO

Where more than one part number is shown, use illustrations to determine correct pad fitment for the application



# Application Data

## Brake Pads, Wear Leads and Fitting Kits

# ANL Braking

<b>ISUZU</b>									
<b>Campo</b> 2.2 TF Series	F	02/88–08/92	Akebono		257	<b>ADB3322</b>	21544		
<b>Faster / KB</b> 1.6, 2.2 2WD / 4WD	F	→12/83	Akebono		259				
	F	→12/83	Akebono		259				
	F	01/84–01/92	Akebono		251		20881		
<b>Faster / JBG, KBD</b> 25, 26	F	→12/83	Akebono		259				
	F	→12/83	Akebono		259				
	F	12/83–01/85	Akebono		251		20881		
	F	01/85–01/92	Akebono		251				
<b>Faster / JBG, KBD</b> 41	F	→12/83	Akebono		259				
	F	→12/83	Akebono		259				
	F	01/84–01/92	Akebono		251				
<b>Midi</b> 1.8, 2.0 Petrol Pick-Up, Van except 4x4	F	01/85–10/97	Sumitomo		251	<b>ADB0306</b>	21115		
<b>Midi</b> 2.0, 2.2 Diesel Pick-Up, Van except 4x4	F	01/85–10/97	Sumitomo		251	<b>ADB0306</b>	21115		
<b>NKR, NKS Truck</b> 3.5T 2.8 TD, 3.0 D, 3.1 D single rear wheel twin rear wheel	F	01/95–01/98				<b>ADB3812</b>			
	F	01/98→			265	<b>ADB01175</b>			
	F	01/98→			293	<b>ADB3918</b>			
<b>NPR Truck</b> 5.0T→6.2T 3.9 D, 4.8 D	F	01/87–01/98				<b>ADB3812</b>			
	F	01/98→			293	<b>ADB3918</b>			
<b>NPT Truck</b> 9.7T 4.7 D	F	01/98→			310	<b>ADB3919</b>			
<b>NQR Truck</b> 7.5T 4.7 D	F	01/95–01/98				<b>ADB3812</b>			
	F	01/98→			310	<b>ADB31174</b>			
<b>NQT Truck</b> 11T 4.7 D	F	01/98→			310	<b>ADB31174</b>			
<b>Pick-Up</b> 1.9, 2.3 2WD / 4WD	F	01/84–09/87			251				
	F	12/87→	Akebono		257	<b>ADB3322</b>	21544		
	R	12/87→							

Where more than one part number is shown, use illustrations to determine correct pad fitment for the application



# Application Data

## Brake Pads, Wear Leads and Fitting Kits

# ANL

## Braking

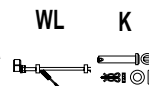
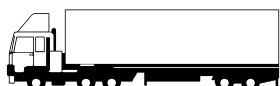

### ISUZU – cont.

ADB0306



133.0 × 47.2 × 16

ADB01175

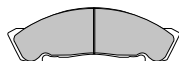

190 × 63 × 20

ADB3322

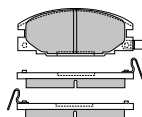

127.0 × 50.8 × 16.5

ADB3812

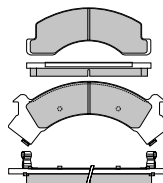

238.0/183.2 × 93.0/69.8 × 22

ADB3918

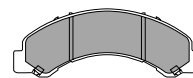

206 × 75 × 20

ADB3919

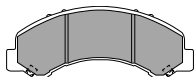

206.2 × 81 × 20

ADB31174

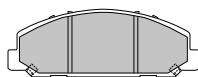

210 × 75 × 20

### IVECO (Includes Iveco Fiat, Iveco Ford, Magirus)

<b>Cargo</b> 0608, 0609, 0611	F	01/87–10/91	Meritor (Lucas)		322	ACV004 <sup>①</sup>	29302		
	F	01/87–10/91	Meritor (Lucas)		322	ACV007 <sup>①</sup>	29033		
	R	01/87–10/91	Meritor (Lucas)		322	ACV004 <sup>①</sup>	29302		
	R	01/87–10/91	Meritor (Lucas)		322	ACV007 <sup>①</sup>	29033		
<b>Note:</b> <sup>①</sup> Replaced by ACV032, see Technical Bulletin #001									
<b>Cargo</b> 0708, 0709, 0711, 0712, 0713	F	01/87–10/91	Meritor (Lucas)		322	ACV004 <sup>①</sup>	29302		
	F	01/87–10/91	Meritor (Lucas)		322	ACV007 <sup>①</sup>	29033		
	R	01/87–10/91	Meritor (Lucas)		322	ACV004 <sup>①</sup>	29302		
	R	01/87–10/91	Meritor (Lucas)		322	ACV007 <sup>①</sup>	29033		
<b>Note:</b> <sup>①</sup> Replaced by ACV032, see Technical Bulletin #001									
<b>Cargo</b> 0808, 0809, 0811, 0813, 0815	F	01/87–10/91	Meritor (Lucas)		322	ACV004 <sup>①</sup>	29302		
	F	01/87–10/91	Meritor (Lucas)		322	ACV007 <sup>①</sup>	29033		
	R	01/87–10/91	Meritor (Lucas)		322	ACV004 <sup>①</sup>	29302		
	R	01/87–10/91	Meritor (Lucas)		322	ACV007 <sup>①</sup>	29033		
<b>Note:</b> <sup>①</sup> Replaced by ACV032, see Technical Bulletin #001									
<b>Cargo</b> 1713, 1714, 1717, 1720, 1724, 1728	F	01/87–10/91	Meritor (Lucas)		322	ACV004 <sup>①</sup>	29302		
	F	01/87–10/91	Meritor (Lucas)		322	ACV007 <sup>①</sup>	29033		
<b>Note:</b> <sup>①</sup> Replaced by ACV032, see Technical Bulletin #001									
<b>CargoPlus</b> 7.5T	F	02/02→	Brembo		304	ACV032	29122	WL005	
	R	02/02→	Brembo		304	ACV032	29122	WL005	

Where more than one part number is shown, use illustrations to determine correct pad fitment for the application



# Application Data

## Brake Pads, Wear Leads and Fitting Kits

# ANL Braking

<b>IVECO – cont.</b>									
<b>Daily→90</b>									
28.8, 30.8, 32.8, 32.9 F8 / 9									
	F	01/82–01/86	Brembo		267	<b>ADB11047</b>	21049		
	F	01/86–01/90	Brembo		267	<b>ADB11054</b>	21188		
	F	01/79–01/82	Lockheed		267	<b>ADB0319</b>	20359		
	F	01/82–01/86	Lockheed		267	<b>ADB0319</b>	20359		
	F	01/82–01/86	Lockheed		267	<b>ADB1412</b>	20359		
	F	01/86–01/90	Lockheed		267	<b>ADB0319</b>	20359		
	F	01/86–01/90	Lockheed		267	<b>ADB11059</b>	20359		
<b>Daily→90</b>									
35.8, 35.8 T, 35.9, 35.9 T, 35.10, 35.10 TD, 40 F8 /									
	F	01/82–01/86	Brembo		267	<b>ADB11047</b>	21049		
	F	01/86–01/90	Brembo		267	<b>ADB11054</b>	21188		
	F	01/79–01/82	Lockheed		267	<b>ADB0319</b>	20359		
	F	01/82–01/86	Lockheed		267	<b>ADB0319</b>	20359		
	F	01/82–01/86	Lockheed		267	<b>ADB1412</b>	20359		
	F	01/86–01/90	Lockheed		267	<b>ADB0319</b>	20359		
	F	01/86–01/90	Lockheed		267	<b>ADB11059</b>	20359		
<b>Daily→90</b>									
40.8 Turbo Diesel									
	F	01/86–01/87	Wabco / Perrot		267	<b>ADB11051</b>	21006		
	F	01/87–01/90	Wabco / Perrot		267	<b>ADB1235</b>	29040		
<b>Daily→90</b>									
40.10W Turbo Diesel									
	F	01/89–01/90	Wabco / Perrot		290	<b>ADB11068</b>	29012		
<b>Daily→90</b>									
45.10									
	F	01/85–01/87	Wabco / Perrot		280	<b>ADB11051</b>	21006		
	F	01/87–01/89	Wabco / Perrot		280	<b>ADB1235</b>	29040		
	F	01/89–01/90	Wabco / Perrot		280	<b>ADB11068</b>	29012		
<b>Daily→90</b>									
49.10, 49.12									
	F	01/85–01/89	Wabco / Perrot		280	<b>ADB11051</b>	21006		
	F	01/89–01/90	Wabco / Perrot		280	<b>ADB11068</b>	29012		
	F	01/89–01/90	Wabco / Perrot		280				
<b>Daily→90</b>									
50.12									
	F	01/85–01/89	Wabco / Perrot		280	<b>ADB11051</b>	21006		
	F	01/89–01/90	Wabco / Perrot		280	<b>ADB11068</b>	29012		
	F	01/89–01/90	Wabco / Perrot		280				
<b>Daily→90</b>									
59.12									
	F	01/85–01/89	Wabco / Perrot		280	<b>ADB11051</b>	21006		
	F	01/89–01/90	Wabco / Perrot		280	<b>ADB11068</b>	29012		
	F	01/89–01/90	Wabco / Perrot		280				
<b>Daily 90→96</b>									
28.8, 30.8, 32.8, 32.9 F8 / 9									
	F	01/90–01/96	Brembo		267	<b>ADB11069</b>	29037		
	F	01/90–01/96	Lockheed		267	<b>ADB0319</b>	20359		
	F	01/90–01/96	Lockheed		267	<b>ADB1319</b>	21160		
<b>Daily 90→96</b>									
35.8, 35.8 T, 35.9, 35.9 T, 35.10, 35.10 TD, 40 F8 /									
	F	01/90–01/96	Brembo		267	<b>ADB1437</b>	29041		
	F	01/90–01/96	Lockheed		267	<b>ADB0319</b>	20359		
	F	01/90–01/96	Lockheed		267	<b>ADB1319</b>	21160		
<b>Daily 90→96</b>									
35.12 Turbo									
	F	01/90–01/96	Wabco / Perrot		290	<b>ADB11068</b>	29012		
	F	01/90–01/96	Wabco / Perrot		280	<b>ADB11068</b>	29012		

Where more than one part number is shown, use illustrations to determine correct pad fitment for the application





# Application Data

## Brake Pads, Wear Leads and Fitting Kits

# ANL

## Braking

						ACV/ADB	WVA	WL	K
					mm		NO.		
<b>IVECO – cont.</b>									
<b>Daily 90→96</b> 40.8 Turbo Diesel	F	01/90–01/96	Wabco / Perrot		267	<b>ADB1235</b>	29040		
<b>Daily 90→96</b> 40.10W Turbo Diesel	F	01/90–01/96	Wabco / Perrot		290	<b>ADB11068</b>	29012		
	F	01/90–01/96	Wabco / Perrot		280	<b>ADB11068</b>	29012		
<b>Daily 90→96</b> 45.10 Sngl WL	F	01/90–01/96	Wabco / Perrot		280	<b>ADB11068</b>	29012		
<b>Daily 90→96</b> 49.10, 49.12 Sngl WL	F	01/90–01/96	Wabco / Perrot		280	<b>ADB11068</b>	29012		
	F	01/90–01/96	Wabco / Perrot		280	<b>ADB11068</b>	29012		
<b>Daily 90→96</b> 50.12 Turbo Sngl WL Dble WL	F	01/90–01/92	Wabco / Perrot		280	<b>ADB11068</b>	29012		
	F	01/90–01/92	Wabco / Perrot		280				
	F	01/90–01/92	Wabco / Perrot		280				
	F	01/92–01/96	Wabco / Perrot		290	<b>ACV020</b>	29001		
<b>Daily 90→96</b> 59.12 Turbo Sngl WL Dble WL	F	01/90–01/92	Wabco / Perrot		280	<b>ADB11068</b>	29012		
	F	01/90–01/92	Wabco / Perrot		280				
	F	01/90–01/92	Wabco / Perrot		280				
	F	01/92–01/96	Wabco / Perrot		290	<b>ACV020</b>	29001		
<b>Daily 96→99</b> 30.8 disc / drum disc / disc	F	01/96–07/99	Brembo		290	<b>ADB11029</b>	29139		
	F	01/96–07/99	Brembo		290	<b>ADB0931</b>	29121	<b>WL031</b>	
	R	01/96–07/99	Brembo		289	<b>ADB0931</b>	29121	<b>WL031</b>	
<b>Daily 96→99</b> 35.8, 35.10, 35.12 disc / drum disc / disc	F	01/96–07/99	Brembo		290	<b>ADB11030</b>	29140	<b>WL031</b>	
	F	01/96–07/99	Brembo		290	<b>ADB0931</b>	29121	<b>WL031</b>	
	R	01/96–07/99	Brembo		289	<b>ADB0931</b>	29121	<b>WL031</b>	
<b>Daily 96→99</b> 35.12 Turbo	F	01/96–07/99	Wabco / Perrot		290	<b>ADB11028</b>	29138		
<b>Daily 96→99</b> 40.8 Turbo Diesel	F	01/96–07/99	Wabco / Perrot		267	<b>ADB1235</b>	29040		
<b>Daily 96→99</b> 40.10W Turbo Diesel	F	01/96–07/99	Wabco / Perrot		290	<b>ADB11028</b>	29138		
	R	01/96–07/99	Wabco / Perrot		289	<b>ADB11028</b>	29138		
<b>Daily 96→99</b> 45.10	F	01/96–07/99	Brembo		290	<b>ADB0931</b>	29121	<b>WL031</b>	
<b>Daily 96→99</b> 50.12 Turbo	F	01/96–07/99	Wabco / Perrot		290	<b>ACV045</b>	29107		

Where more than one part number is shown, use illustrations to determine correct pad fitment for the application





































# Application Data

## Brake Pads, Wear Leads and Fitting Kits

# ANL

## Braking

										
<b>IVECO – cont.</b> Daily 96→99 59.12 Turbo			F	01/96–07/99	Wabco / Perrot		290	ACV045	29107	
Daily 99→ 29 L9, 29 L11 3.2 T  non ABS ABS			F	07/99→	Brembo		276	ADB0909	29121	WL031
			R	07/99→	Brembo		276	ADB0909	29121	WL031
Daily 99→ 35 S9, 35 S11, 35 S13 3.5 T single rear wheel twin rear wheel			F	07/99→	Brembo		290	ADB0909	29121	WL031
			F	07/99→	Brembo		290	ADB0931	29121	WL031
Daily 99→ 35 S9, 35 S11, 35 S13 3.5 T single rear wheel twin rear wheel			R	07/99→	Brembo		289	ADB01034	29123	WL031
			R	07/99→	Brembo		289	ADB0931	29121	WL031
Daily 99→ 35 C11, 35 C13 3.5 T			F	07/99→	Brembo		290	ADB0931	29121	WL031
			R	07/99→	Brembo		289	ADB0931	29121	WL031
Daily 99→ 40 C13			F	07/99→	Brembo		290	ADB0931	29121	WL031
			R	07/99→	Brembo		289	ADB0931	29121	WL031
Daily 99→ 50 C13			F	07/99→	Brembo		290	ADB0931	29121	WL031
			R	07/99→	Brembo		289	ADB0931	29121	WL031
Daily 99→ 60 C13			F	07/99→	Brembo		290	ADB01173	29160	WL031
			R	07/99→	Brembo		289	ADB01173	29160	WL031
Daily 99→ 65 C13			F	07/99→	Brembo		290	ADB01173	29160	WL031
			R	07/99→	Brembo		289	ADB01173	29160	WL031
EuroCargo 60.12, 79.14			F	01/87–01/91	Wabco / Perrot		315	ACV001	29017	
EuroCargo 60 E Series			F	01/96→	Brembo		304	ACV032	29122	WL005
			F	01/91→	Meritor (Lucas)		304	ACV021 <sup>①</sup>	29065	WL027/ WL025
EuroCargo 60 E Series			R	01/96→	Brembo		304	ACV032	29122	WL005
			R	01/91→	Meritor (Lucas)		304	ACV021 <sup>①</sup>	29065	WL027/ WL025
<b>Note:</b> <sup>①</sup> Replaced by ACV032, see Technical Bulletin #001										
EuroCargo 65 E Series			F	01/96→	Brembo		304	ACV032	29122	WL005
			F	01/91→	Meritor (Lucas)		304	ACV021 <sup>①</sup>	29065	WL027/ WL025

–cont.

Where more than one part number is shown, use illustrations to determine correct pad fitment for the application



# Application Data

## Brake Pads, Wear Leads and Fitting Kits

# ANL

## Braking

						ACV/ADB	WVA NO.	WL	K
<b>IVECO – cont.</b> EuroCargo – cont.	R	01/96→	Brembo Meritor (Lucas)		304 304	<b>ACV032</b> <b>ACV021</b> <sup>①</sup>	29122 29065	<b>WL005</b> <b>WL027/</b> <b>WL025</b>	
	R	01/91→							
<b>Note:</b> ① Replaced by ACV032, see Technical Bulletin #001									
<b>EuroCargo</b> 75 E Series	F	01/96→	Brembo Meritor (Lucas)		304 304	<b>ACV032</b> <b>ACV021</b> <sup>①</sup>	29122 29065	<b>WL005</b> <b>WL027/</b> <b>WL025</b>	
	F	01/91→							
	R	01/96→	Brembo Meritor (Lucas)		304 304	<b>ACV032</b> <b>ACV021</b> <sup>①</sup>	29122 29065	<b>WL005</b> <b>WL027/</b> <b>WL025</b>	
	R	01/91→							
<b>Note:</b> ① Replaced by ACV032, see Technical Bulletin #001									
<b>EuroCargo</b> 80 E Series	F	01/96→	Brembo Meritor (Lucas)		322 322	<b>ACV032</b> <b>ACV011</b> <sup>①</sup>	29122 21302	<b>WL005</b> <b>WL027/</b> <b>WL025</b>	
	F	01/91→							
	R	01/91→	Brembo Meritor (Lucas)		322 322	<b>ACV032</b> <b>ACV011</b> <sup>①</sup>	29122 21302	<b>WL005</b> <b>WL027/</b> <b>WL025</b>	
	R	01/91→							
<b>Note:</b> ① Replaced by ACV032, see Technical Bulletin #001									
<b>EuroCargo</b> 85 E Series	F	01/96→	Brembo Meritor (Lucas)		322 322	<b>ACV032</b> <b>ACV011</b> <sup>①</sup>	29122 21302	<b>WL005</b> <b>WL027/</b> <b>WL025</b>	
	F	01/91→							
	R	01/91→	Brembo Meritor (Lucas)		322 322	<b>ACV032</b> <b>ACV011</b> <sup>①</sup>	29122 21302	<b>WL005</b> <b>WL027/</b> <b>WL025</b>	
	R	01/91→							
<b>Note:</b> ① Replaced by ACV032, see Technical Bulletin #001									
<b>EuroCargo</b> 95 E Series 4x4	F	01/96→	Brembo Meritor (Lucas)		322 322	<b>ACV032</b> <b>ACV011</b> <sup>①</sup>	29122 21302	<b>WL005</b> <b>WL027/</b> <b>WL025</b>	
	F	01/91→							
	R	01/91→	Brembo Meritor (Lucas)		322 322	<b>ACV032</b> <b>ACV011</b> <sup>①</sup>	29122 21302	<b>WL005</b> <b>WL027/</b> <b>WL025</b>	
	R	01/91→							
<b>Note:</b> ① Replaced by ACV032, see Technical Bulletin #001									
<b>EuroCargo</b> 100 E Series	F	01/96→	Brembo Meritor (Lucas)		322 322	<b>ACV032</b> <b>ACV011</b> <sup>①</sup>	29122 21302	<b>WL005</b> <b>WL027/</b> <b>WL025</b>	
	F	01/91→							
	R	01/91→	Brembo Meritor (Lucas)		322 322	<b>ACV032</b> <b>ACV011</b> <sup>①</sup>	29122 21302	<b>WL005</b> <b>WL027/</b> <b>WL025</b>	
	R	01/91→							
<b>Note:</b> ① Replaced by ACV032, see Technical Bulletin #001									

Where more than one part number is shown, use illustrations to determine correct pad fitment for the application



# Application Data

## Brake Pads, Wear Leads and Fitting Kits

# ANL Braking

Model	Year	Manufacturer	Disc Th	ACV/ADB	WVA NO.	WL	K		
<b>IVECO – cont.</b> EuroCargo 110 E Series	F 09/91–01/99	Knorr	370	<b>ACV016</b>	29032	WL007/ WL008			
	F 01/99→	Wabco / Perrot	370	<b>ACV039</b> <sup>①</sup>	29088	WL014		K006	
	F 01/99→	Wabco / Perrot	370	<b>ACV040</b> <sup>②</sup>	29091	WL014		K006	
<b>Note:</b> Disc Th 30→26mm use <sup>①</sup> , 26→24mm use <sup>②</sup>									
<b>EuroCargo</b> 120 E Series	F 09/91–01/99	Knorr	370	<b>ACV016</b>	29032	WL007/ WL008			
	F 01/99→	Wabco / Perrot	370	<b>ACV039</b> <sup>①</sup>	29088	WL014		K006	
	F 01/99→	Wabco / Perrot	370	<b>ACV040</b> <sup>②</sup>	29091	WL014		K006	
<b>Note:</b> Disc Th 30→26mm use <sup>①</sup> , 26→24mm use <sup>②</sup>									
<b>EuroCargo</b> 130 E Series	F 09/91→	Knorr	370	<b>ACV016</b>	29032	WL007/ WL008			
<b>EuroCargo</b> 135 E Series 4x4	F 01/97→	Knorr	370	<b>ACV016</b>	29032	WL007/ WL008			
<b>EuroCargo</b> 140 E Series	F 09/91→	Knorr	370	<b>ACV016</b>	29032	WL007/ WL008			
<b>EuroCargo</b> 150 E Series	F 09/91→	Knorr	370	<b>ACV016</b>	29032	WL007/ WL008			
<b>EuroCargo</b> 170 E Series	F 09/91–08/98	Knorr	430	<b>ACV017</b>	29011	WL007/ WL008			
	F 08/98→	Knorr	436	<b>ACV041</b>	29106	WL006		K005/ K018	
<b>EuroCargo</b> 175 E Series	F 09/91–08/98	Knorr	430	<b>ACV017</b>	29011	WL007/ WL008			
	F 08/98→	Knorr	436	<b>ACV041</b>	29106	WL006		K005/ K018	
<b>EuroCargo</b> 176 E Series	F 09/91–08/98	Knorr	430	<b>ACV017</b>	29011	WL007/ WL008			
	F 08/98→	Knorr	436	<b>ACV041</b>	29106	WL006		K005/ K018	
<b>EuroCargo</b> 179 E Series	F 09/91–08/98	Knorr	430	<b>ACV017</b>	29011	WL007/ WL008			
	F 08/98→	Knorr	436	<b>ACV041</b>	29106	WL006		K005/ K018	
<b>EuroCargo</b> 180 E Series	F 01/91→	Meritor (Lucas)	322	<b>ACV011</b> <sup>①</sup>	21302	WL027/ WL025			
	R 01/91→	Meritor (Lucas)	322	<b>ACV011</b> <sup>①</sup>	21302	WL027/ WL025			
<b>Note:</b> <sup>①</sup> Replaced by ACV032, see Technical Bulletin #001									

Where more than one part number is shown, use illustrations to determine correct pad fitment for the application































# Application Data

## Brake Pads, Wear Leads and Fitting Kits

# ANL

## Braking

										
<b>IVECO – cont.</b>										
<b>EuroCargo</b> 210 E Series	F	09/91→	Knorr		370	ACV016	29032	WL007/ WL008		
<b>EuroCargo</b> 250 E Series	F	09/91→	Knorr		370	ACV016	29032	WL007/ WL008		
<b>EuroCargo</b> 260 E Series	F	09/91→	Knorr		370	ACV016	29032	WL007/ WL008		
<b>EuroCargo</b> 280 E Series	F	09/91→	Knorr		370	ACV016	29032	WL007/ WL008		
<b>EuroCargo</b> 320 E Series	F	09/91→	Knorr		370	ACV016	29032	WL007/ WL008		
<b>EuroCargo</b> 325 E Series	F	09/91–08/98	Knorr		430	ACV017	29011	WL007/ WL008		
	F	08/98→	Knorr		436	ACV041	29106	WL006	K005/ K018	
<b>EuroCargo</b> 390 E Series	F	09/91–08/98	Knorr		430	ACV017	29011	WL007/ WL008		
	F	08/98→	Knorr		436	ACV041	29106	WL006	K005/ K018	
<b>EuroFire</b> 130 E	F	09/91→	Knorr		370	ACV016	29032	WL007/ WL008		
<b>EuroFire</b> 150 E	F	09/91→	Knorr		370	ACV016	29032	WL007/ WL008		
<b>EuroStar</b> LD190 E 38, LD190 E 42, LD190 E 47, LD190 E	F	01/93–08/98	Knorr		430	ACV017	29011	WL007/ WL008		
	F	01/97→	Knorr		436	ACV041	29106	WL006	K005/ K018	
<b>EuroStar</b> LD240 E 38, LD240 E 42, LD240 E 47, LD240 E	F	01/93–08/98	Knorr		430	ACV017	29011	WL007/ WL008		
6x2, 6x2/4	F	01/97→	Knorr		436	ACV041	29106	WL006	K005/ K018	
<b>EuroStar</b> LD260 E 38, LD260 E 42, LD260 E 47, LD260 E	F	01/93–08/98	Knorr		430	ACV017	29011	WL007/ WL008		
6x4	F	01/97→	Knorr		436	ACV041	29106	WL006	K005/ K018	

Where more than one part number is shown, use illustrations to determine correct pad fitment for the application



# Application Data

## Brake Pads, Wear Leads and Fitting Kits

# ANL

## Braking

<b>IVECO – cont.</b> EuroStar LD325 E 27	F	01/93–08/98	Knorr		430	<b>ACV017</b>	29011	WL007/ WL008		
	F	01/97→	Knorr		436	<b>ACV041</b>	29106	WL006	K005/ K018	
EuroStar LD380 E 6x2  6x2 Twinsteer   R1 axle	F	01/93–08/98	Knorr		430	<b>ACV017</b>	29011	WL007/ WL008		
	F	01/97→	Knorr		436	<b>ACV041</b>	29106	WL006	K005/ K018	
	F	01/93–08/98	Knorr		430	<b>ACV017</b>	29011	WL007/ WL008		
	F	01/97→	Knorr		436	<b>ACV041</b>	29106	WL006	K005/ K018	
EuroStar LD380 E 6x4	F	01/93–08/98	Knorr		430	<b>ACV017</b>	29011	WL007/ WL008		
	F	01/97→	Knorr		436	<b>ACV041</b>	29106	WL006	K005/ K018	
EuroStar LD390 E 30, LD390 E 34	F	01/93–08/98	Knorr		430	<b>ACV017</b>	29011	WL007/ WL008		
	F	01/97→	Knorr		436	<b>ACV041</b>	29106	WL006	K005/ K018	
EuroStar LD400 E 38, LD400 E 42 6x2/4	F	01/93–08/98	Knorr		430	<b>ACV017</b>	29011	WL007/ WL008		
	F	01/97→	Knorr		436	<b>ACV041</b>	29106	WL006	K005/ K018	
EuroStar LD420 E 6x2  6x2 Twinsteer   R1 axle	F	01/93–08/98	Knorr		430	<b>ACV017</b>	29011	WL007/ WL008		
	F	01/97→	Knorr		436	<b>ACV041</b>	29106	WL006	K005/ K018	
	F	01/93–08/98	Knorr		430	<b>ACV017</b>	29011	WL007/ WL008		
	F	01/97→	Knorr		436	<b>ACV041</b>	29106	WL006	K005/ K018	
EuroStar LD430 E 38, LD430 E 42 4x2 Tractors	R	01/93–08/98	Knorr		430	<b>ACV017</b>	29011	WL007/ WL008		
	F	08/98→	Knorr		436	<b>ACV041</b>	29106	WL006	K005/ K018	

Where more than one part number is shown, use illustrations to determine correct pad fitment for the application



# Application Data

## Brake Pads, Wear Leads and Fitting Kits

# ANL

## Braking

						ACV/ADB	WVA NO.	WL	K
					mm				
<b>IVECO – cont.</b> EuroStar LD440 E 38, LD440 E 42, LD440 E 47, LD440 E 6x4	F	01/93–08/98	Knorr		430	ACV017	29011	WL007/ WL008	K005/ K018
	F	01/97→	Knorr		436	ACV041	29106	WL006	
<b>EuroStar</b> LD470 E 6x2 Twinsteer R1 axle	F	01/93–08/98	Knorr		430	ACV017	29011	WL007/ WL008	K005/ K018
	F	01/97→	Knorr		436	ACV041	29106	WL006	
	R	01/93–08/98	Knorr		430	ACV017	29011	WL007/ WL008	
<b>EuroStar</b> LD520 E 6x2 Twinsteer R1 axle	F	01/93–08/98	Knorr		430	ACV017	29011	WL007/ WL008	K005/ K018
	F	01/97→	Knorr		436	ACV041	29106	WL006	
	R	01/93–08/98	Knorr		430	ACV017	29011	WL007/ WL008	
<b>EuroStar</b> LD520 E 6x4	F	01/93–08/98	Knorr		430	ACV017	29011	WL007/ WL008	K005/ K018
	F	01/97→	Knorr		436	ACV041	29106	WL006	
<b>EuroTech</b> 180 → 400 (E24, E27, E30, E34, E38, E42) 4x2 Rigid, Tipper	F	09/92–01/97	Knorr		430	ACV017	29011	WL007/ WL008	K005/ K018
	F	01/97→	Knorr		436	ACV041	29106	WL006	
<b>EuroTech</b> 325 → 430 (E27, E30, E34, E38, E42) 4x2 Tractors	F	09/92–01/97	Knorr		430	ACV017	29011	WL007/ WL008	
<b>EuroTech</b> 325 → 400 (E27, E30, E34, E38, E42) 4x2 Tractors	F	01/97→	Knorr		436	ACV041	29106	WL006	K005/ K018
<b>EuroTech</b> 240 (E38, E42) 6x2 Rigid	F	09/92–01/97	Knorr		430	ACV017	29011	WL007/ WL008	K005/ K018
	F	01/97→	Knorr		436	ACV041	29106	WL006	

Where more than one part number is shown, use illustrations to determine correct pad fitment for the application



# Application Data

## Brake Pads, Wear Leads and Fitting Kits

# ANL Braking

<b>IVECO – cont.</b> EuroTech 400 → 440 (E38, E42) 6x2 Tractors	F	09/92–01/97	Knorr		430	ACV017	29011	WL007/ WL008	
	F	01/97→	Knorr		436	ACV041	29106	WL006	K005/ K018
EuroTech 400 (E34, E38) 6x2 Twinsteer	F	09/92–01/97	Knorr		430	ACV017	29011	WL007/ WL008	
	F	01/97→	Knorr		436	ACV041	29106	WL006	K005/ K018
	R	09/92–01/97	Knorr		430	ACV017	29011	WL007/ WL008	
	R	01/97→	Knorr		436	ACV041	29106	WL006	K005/ K018
EuroTech 260 (E38, E42) 6x4 Rigid	F	09/92–01/97	Knorr		430	ACV017	29011	WL007/ WL008	
	F	01/97→	Knorr		436	ACV041	29106	WL006	K005/ K018
EuroTech 400 (E34, E38) 6x4 Twinsteer	F	09/92–01/97	Knorr		430	ACV017	29011	WL007/ WL008	
	F	01/97→	Knorr		436	ACV041	29106	WL006	K005/ K018
	R	09/92–01/97	Knorr		430	ACV017	29011	WL007/ WL008	
	R	01/97→	Knorr		436	ACV041	29106	WL006	K005/ K018
EuroTrakker Cursor 8 8x4 Rigid, Tipper	F	09/99→	Knorr		436	ACV041	29106	WL006	K005/ K018
EuroTrakker Cursor 10 8x4 Rigid, Tipper	F	09/99→	Knorr		436	ACV041	29106	WL006	K005/ K018
Pegaso Ekus 87 75.28, 32, 35, 40, 46, 50, 56 100.28, 32, 35, 40, 46, 50, 56	F	01/87→	Ate				20280		
	F	01/87→	Ate				20280		
Pegaso Furgoneta 54	F	01/87–02/94	Lucas			ADB1254	20741		
PSV 315.17 Turbo	F	01/81→	Knorr		315		29688		

Where more than one part number is shown, use illustrations to determine correct pad fitment for the application





# Application Data

## Brake Pads, Wear Leads and Fitting Kits

# ANL Braking

						ACV/ADB	WVA NO.	WL	K
					mm				
<b>IVECO – cont.</b> PSV 370.25, 370.30, 370.35	F	01/84→	Wabco / Perrot		417	<b>ACV023</b>	29074		
	F	01/84→	Wabco / Perrot		417	<b>ACV018</b>	29075		
<b>PSV 471 - 10.20, 471 - 12.20</b>	F	01/84-01/88	Wabco / Perrot		425				
<b>PSV 480.21Turbo, 490.12 Turbo, 490.22 Turbo</b>	F	01/86→	Wabco / Perrot		425				
<b>PSV 580.21 Turbocity - S</b>	F	01/88→	Wabco / Perrot		425				
<b>PSV City Bus</b> A 70.14	F	01/98→	Wabco / Perrot		322	<b>ACV022</b>	29017		
<b>PSV Daily →99</b> 45.10, 49.10	F	01/87-01/90	Wabco / Perrot		280	<b>ADB1235</b>	29040		
	F	01/90-07/99	Wabco / Perrot		280	<b>ADB11068</b>	29012		
<b>PSV Daily →99</b> 49.12	F	01/90-01/97	Wabco / Perrot		280	<b>ADB11068</b>	29012		
<b>PSV Daily →99</b> 50.12 Turbo	F	01/92-01/97	Wabco / Perrot		290	<b>ACV020</b>	29001		
<b>PSV Daily →99</b> 52.10, 52.12	F	01/97-07/99	Wabco / Perrot		290	<b>ADB11068</b>	29012		
<b>PSV Daily →99</b> 59.12 Turbo	F	01/92-01/97	Wabco / Perrot		290	<b>ACV045</b>	29107		
<b>PSV Daily →99</b> 64.12	F	01/97-07/99	Wabco / Perrot		290	<b>ACV045</b>	29107		
<b>PSV Daily 99→</b> 35 S13	F	07/99→	Brembo		290	<b>ADB0931</b>	29121	<b>WL031</b>	
	R	07/99→	Brembo		289	<b>ADB0931</b>	29121	<b>WL031</b>	
<b>PSV Daily 99→</b> 40 C13	F	07/99→	Brembo		290	<b>ADB0931</b>	29121	<b>WL031</b>	
	R	07/99→	Brembo		289	<b>ADB0931</b>	29121	<b>WL031</b>	
<b>PSV Daily 99→</b> 50 C13	F	07/99→	Brembo		290	<b>ADB0931</b>	29121	<b>WL031</b>	
	R	07/99→	Brembo		289	<b>ADB0931</b>	29121	<b>WL031</b>	
<b>PSV Daily 99→</b> 60 C13	F	07/99→	Brembo		290	<b>ADB01173</b>	29160	<b>WL031</b>	
	R	07/99→	Brembo		289	<b>ADB01173</b>	29160	<b>WL031</b>	
<b>PSV Daily 99→</b> 65 C13	F	07/99→	Brembo		290	<b>ADB01173</b>	29160	<b>WL031</b>	
	R	07/99→	Brembo		289	<b>ADB01173</b>	29160	<b>WL031</b>	
<b>PSV Irisbus</b> CityClass	F	01/92→	Wabco / Perrot		417	<b>ACV018</b>	29075		

Where more than one part number is shown, use illustrations to determine correct pad fitment for the application



# Application Data

## Brake Pads, Wear Leads and Fitting Kits

# ANL Braking

						ACV/ADB	WVA NO.	WL	K
					mm				
<b>IVECO – cont.</b> PSV Irisbus EuroClass	F	01/92→	Wabco / Perrot		417	<b>ACV023</b>	29074		
	F	01/92→	Wabco / Perrot		417	<b>ACV018</b>	29075		
<b>PSV Irisbus</b> EuroRider	F	01/92→	Wabco / Perrot		417	<b>ACV023</b>	29074		
	F	01/92→	Wabco / Perrot		417	<b>ACV018</b>	29075		
<b>PSV Irisbus</b> Maxim 80 E	F	01/98→	Brembo		322	<b>ACV032</b>	29122	<b>WL005</b>	
	R	01/98→	Brembo		322	<b>ACV032</b>	29122	<b>WL005</b>	
<b>PSV Irisbus</b> Maxim 100 E	F	01/98→	Brembo		322	<b>ACV032</b>	29122	<b>WL005</b>	
	R	01/98→	Brembo		322	<b>ACV032</b>	29122	<b>WL005</b>	
<b>PSV Irisbus</b> Scholabus 150 E	F	08/98→	Knorr		436	<b>ACV041</b>	29106	<b>WL006</b>	<b>K005/ K018</b>
<b>PSV Magirus Bus</b> R 81	F	01/81→	Knorr		315		29688		
<b>Stralis</b> Cursor 10 400, 430	F	02/02→	Knorr			<b>ACV041</b>	29106	<b>WL006</b>	<b>K005/ K018</b>
	R	02/02→	Knorr			<b>ACV041</b>	29106	<b>WL006</b>	<b>K005/ K018</b>
<b>Stralis</b> Cursor 13 480, 540	F	02/02→	Knorr			<b>ACV041</b>	29106	<b>WL006</b>	<b>K005/ K018</b>
	R	02/02→	Knorr			<b>ACV041</b>	29106	<b>WL006</b>	<b>K005/ K018</b>
<b>SuperCargo</b> 170 (E15, E18, E23) 4x2 Rigid, Tipper 4x2 Rigid, Tipper	F	01/93→	Knorr		430	<b>ACV017</b>	29011	<b>WL007/ WL008</b>	
<b>SuperCargo</b> 260, 320 (E27) 6x4 Rigid, Tipper 6x4 Rigid, Tipper	F	01/93→	Knorr		430	<b>ACV017</b>	29011	<b>WL007/ WL008</b>	
<b>Zeta</b> 65.12 → 79.14	F	01/87–01/92	Meritor (Lucas)		315	<b>ACV011</b> <sup>Ⓢ</sup>	21302	<b>WL027/ WL025</b>	
	F	01/87–01/92	Wabco / Perrot		315	<b>ACV001</b>	29017		
	F	01/87–01/92	Wabco / Perrot		315	<b>ACV003</b>	29024		
	F	01/92→	Wabco / Perrot		322	<b>ACV022</b>	29017		

Where more than one part number is shown, use illustrations to determine correct pad fitment for the application



# Application Data

## Brake Pads, Wear Leads and Fitting Kits

# ANL Braking

						ACV/ADB	WVA NO.	WL	K
<b>IVECO – cont.</b> Zeta – cont.									
		R 01/87–01/92 R 01/87–01/92 R 01/92→	Meritor (Lucas) Meritor (Lucas) Wabco / Perrot			ACV004 <sup>Ⓢ</sup> ACV007 <sup>Ⓢ</sup>	29302 29033		
Note: <sup>Ⓢ</sup> Replaced by ACV032, see Technical Bulletin #001									
<b>Zeta</b> 95.14, 109.14		F 01/87–01/92 F 01/87–01/92 F 01/87–01/92	Wabco / Perrot Wabco / Perrot Meritor (Lucas)		315 315 322	ACV001 ACV003 ACV011 <sup>Ⓢ</sup>	29017 29024 21302	WL027/ WL025	
Note: <sup>Ⓢ</sup> Replaced by ACV032, see Technical Bulletin #001									
<b>Z Range</b> 79.13, 109.14		F 01/87–01/92 F 01/87–01/92 F 01/92→	Wabco / Perrot Wabco / Perrot Wabco / Perrot		315 315 322	ACV001 ACV003 ACV022	29017 29024 29017		
<b>ACV001</b>	<b>ACV003</b>	<b>ACV004</b> <u>Replaced by ACV032</u>		<b>ACV007</b> <u>Replaced by ACV032</u>		<b>ACV011</b> <u>Replaced by ACV032</u>			
191.0 × 87.0 × 23	191.0 × 87.0 × 23	177 × 77.0 × 22	177 × 77 × 22	175.0 × 77.0 × 22					
<b>ACV016</b>	<b>ACV017</b>	<b>ACV018</b>	<b>ACV020</b>	<b>ACV021</b> <u>Replaced by ACV032</u>					
206.0 × 107.0 × 25	241.0 × 125.0 × 25	180.0 × 106.0 × 20	174.0 × 69.0 × 20	175.0 × 85.5 × 22					
<b>ACV022</b>	<b>ACV023</b>	<b>ACV032</b>	<b>ACV039</b>	<b>ACV040</b>					
191.0 × 87.0 × 23	180.0 × 106.0 × 20	175 × 86 × 22	175.6 × 85.6 × 26	175.6 × 85.6 × 27					

Where more than one part number is shown, use illustrations to determine correct pad fitment for the application



# Application Data

## Brake Pads, Wear Leads and Fitting Kits

# ANL Braking

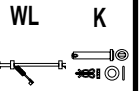

### IVECO – cont.

ACV041

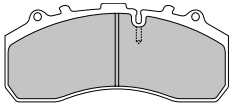

248.0 × 108.0 × 30

ACV045

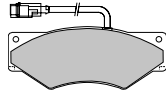

174.0 × 69.0 × 20

ADB0319



104.9 × 74.7 × 18

ADB0909

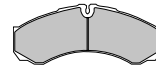

165 × 66 × 17

ADB0931

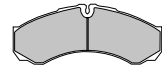

165 × 66 × 19.5

ADB01034

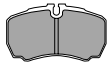

110 × 64 × 20

ADB01173

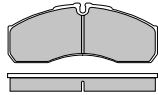

165 × 68 × 19.5

ADB1235

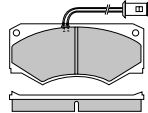

149.0 × 69.0 × 18

ADB1254

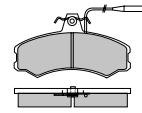

130.0 × 71.5 × 19

ADB1319

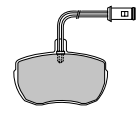

104.9 × 74.7 × 18

ADB1412

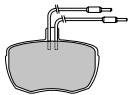

104.9 × 74.7 × 18

ADB1437

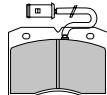

109.7 × 73.0 × 18.3

ADB11028

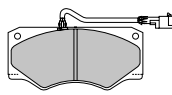

149.0 × 69.0 × 18

ADB11029

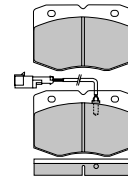

110.0 × 73.0 × 18

ADB11030

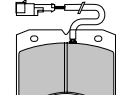

109.7 × 73.0 × 18

ADB11047

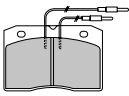

109.7 × 73.0 × 18.3

ADB11051

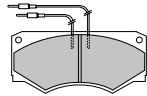

149.0 × 69.0 × 18

ADB11054

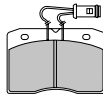

109.7 × 73.0 × 18.3

ADB11059

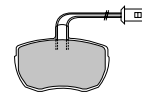

104.9 × 74.7 × 18

ADB11068

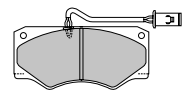

149.0 × 69.0 × 18

ADB11069

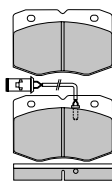

110.0 × 73.0 × 18.5

Where more than one part number is shown, use illustrations to determine correct pad fitment for the application



# Application Data

## Brake Pads, Wear Leads and Fitting Kits

# ANL Braking



KAROSA (RECREO)									
PSV 930E, 940E	F	01/97→	Knorr		430	ACV041	29106	WL009	K005/ K018
PSV City Bus Renault chassis	F	01/93→	Meritor (Lucas)		438	ACV014 <sup>①</sup>	29030	WL004	K002/ K016
	F	01/93→	Meritor (Lucas)		438	ACV030 <sup>②</sup>	29053	WL004	K013/ K016

Note: Disc Th 45→41mm use <sup>①</sup>, 41→38mm use <sup>②</sup>

ACV014

ACV030

ACV041

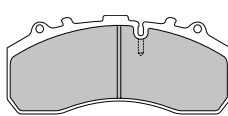
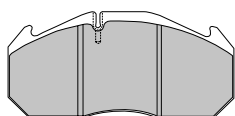
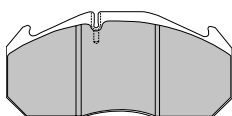

250.0 × 118.0 × 28

250.0 × 118.0 × 28

248.0 × 108.0 × 30

KASSBOHRER									
Setra (S Series) S110, S120 E, V	F	03/79-01/89	Knorr		392				
Setra (S Series) S130 S	F	01/82-01/89	Knorr		392				
Setra (S Series) S130 ES	F	01/82-01/86	Knorr		396	ACV012	29498		
Setra (S Series) S140 except Knorr K85 Brakes Knorr K85 Brakes	F	01/83-01/89	Knorr		396	ACV012	29498		
	F	01/83→	Knorr		396	ACV006	29747		K001
Setra (S Series) S150	F	03/74-01/89	Knorr		392				
Setra (S Series) S180	F	03/74-01/89	Knorr		392				
Setra (S Series) S200	F	03/74-01/89	Knorr		392				
Setra (S Series) S209	F	10/77→							
	R	10/77→							
Setra (S Series) S210 HD, HDV	F	01/83-01/89	Knorr		396	ACV012	29498		
	F	01/89→	Knorr		406	ACV006	29747		K001

Where more than one part number is shown, use illustrations to determine correct pad fitment for the application



# Application Data

## Brake Pads, Wear Leads and Fitting Kits

# ANL Braking

KASSBOHRER – cont.									
<b>Setra (S Series)</b> S211, S212, S213 H, HD, U, UL	F	10/77–01/88	Knorr		396	ACV012	29498		
<b>Setra (S Series)</b> S211, S213, S214 HDH, SL, UL	F	01/89→	Knorr		406	ACV006	29747		K001
<b>Setra (S Series)</b> S215 HDH HDH, SL, UL NR	F	01/83–01/89	Knorr		396	ACV012	29498	WL004	K001 K002/ K016 K013/ K016
	F	01/89→	Knorr		406	ACV006	29747		
	F	01/91→	Meritor (Lucas)		438	ACV014 <sup>①</sup>	29030		
	F	01/91→	Meritor (Lucas)		438	ACV030 <sup>②</sup>	29053		
<b>Note: Disc Th 45→41mm use <sup>①</sup>, 41→38mm use <sup>②</sup></b>									
<b>Setra (S Series)</b> S216 HDH HDS, HDSI	F	01/83–01/89	Knorr		396	ACV012	29498		K001
	F	01/89→	Knorr		406	ACV006	29747		
<b>Setra (S Series)</b> S228 DT	F	01/83–01/89	Knorr		396	ACV012	29498		K001
	F	01/89→	Knorr		406	ACV006	29747		
<b>Setra (S Series)</b> S300 NC City	F	01/91→	Meritor (Lucas)		432	ACV014 <sup>①</sup>	29030	WL003	K002/ K016 K013/ K016
	F	01/91→	Meritor (Lucas)		432	ACV030 <sup>②</sup>	29053		
<b>Note: Disc Th 45→41mm use <sup>①</sup>, 41→38mm use <sup>②</sup></b>									
<b>Setra (S Series)</b> S309, S312 HD, HDH	F	01/91→	Meritor (Lucas)		432	ACV014 <sup>①</sup>	29030	WL003	K002/ K016 K013/ K016
	F	01/91→	Meritor (Lucas)		432	ACV030 <sup>②</sup>	29053		
<b>Note: Disc Th 45→41mm use <sup>①</sup>, 41→38mm use <sup>②</sup></b>									
<b>Setra (S Series)</b> S313 UL	F	01/91→	Meritor (Lucas)		438	ACV014 <sup>①</sup>	29030	WL004	K002/ K016 K013/ K016
	F	01/91→	Meritor (Lucas)		438	ACV030 <sup>②</sup>	29053		
<b>Note: Disc Th 45→41mm use <sup>①</sup>, 41→38mm use <sup>②</sup></b>									
<b>Setra (S Series)</b> S315 HD, HDH	F	01/91→	Meritor (Lucas)		432	ACV014 <sup>①</sup>	29030	WL003	K002/ K016 K013/ K016 –cont.
	F	01/91→	Meritor (Lucas)		432	ACV030 <sup>②</sup>	29053		

Where more than one part number is shown, use illustrations to determine correct pad fitment for the application



# Application Data

## Brake Pads, Wear Leads and Fitting Kits

# ANL Braking

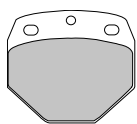
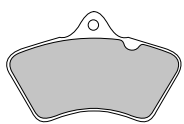
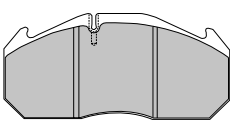
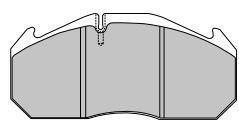
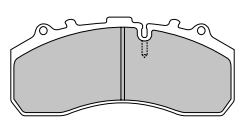
						ACV/ADB	WVA NO.	WL	K
						mm			
<b>KASSBOHRER – cont.</b> Setra (S Series) – cont. NF	F	01/91→	Meritor (Lucas)		438	ACV014 <sup>①</sup>	29030	WL004	K002/ K016
	F	01/91→	Meritor (Lucas)		438	ACV030 <sup>②</sup>	29053	WL004	K013/ K016
Note: Disc Th 45→41mm use <sup>①</sup> , 41→38mm use <sup>②</sup>									
Setra (S Series) S319 UL	F	01/91→	Meritor (Lucas)		438	ACV014 <sup>①</sup>	29030	WL004	K002/ K016
	F	01/91→	Meritor (Lucas)		438	ACV030 <sup>②</sup>	29053	WL004	K013/ K016
Note: Disc Th 45→41mm use <sup>①</sup> , 41→38mm use <sup>②</sup>									
Setra (S Series) S328 DT	F	01/95→	Knorr		430	ACV041	29106	WL009	K005/ K018
Setra (S Series) S415, S417 HD, HDH	F	01/01→	Knorr		430	ACV041	29106	WL009	K005/ K018
	R	01/01→	Knorr		430	ACV041	29106	WL009	K005/ K018
<div style="display: flex; justify-content: space-around; text-align: center;"> <div> <p>ACV006</p>  <p>140.0 × 121.0 × 32</p> </div> <div> <p>ACV012</p>  <p>192 × 114 × 20</p> </div> <div> <p>ACV014</p>  <p>250.0 × 118.0 × 28</p> </div> <div> <p>ACV030</p>  <p>250.0 × 118.0 × 28</p> </div> <div> <p>ACV041</p>  <p>248.0 × 108.0 × 30</p> </div> </div>									
<b>KIA</b>									
Besta 2.2 D	F	07/92→	Akebono			ADB0168	20002		
	F	07/92→	Akebono			ADB3168	20002		
	R	07/92→			185				
Pregio 2.7	F	02/97→				ADB3721	23484		
Where more than one part number is shown, use illustrations to determine correct pad fitment for the application									



# Application Data

## Brake Pads, Wear Leads and Fitting Kits

# ANL

## Braking

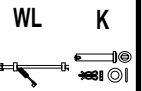

### KIA – cont.

ADB0168

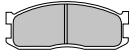

133.0 × 52.0 × 14.5

ADB3168

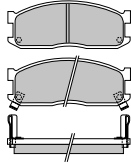

133.0 × 52.0 × 14.5

ADB3721

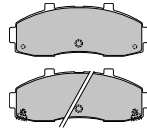

154 × 59 × 17

### KNORR - BREMSEN

1 V 20			Knorr					
2 V 20			Knorr		ACV012	29498		
K 65			Knorr			29688		
K 75			Knorr					
K 85			Knorr		ACV006	29747		K001
SB 5000 17.5" wheels			Knorr		ACV038	29115		K005/ K018
SB 6000 19.5" wheels			Knorr		ACV043	29095	WL015	K005/ K018
SN 6000 19.5" wheels	06/03→		Knorr		ACV061	29165		K005/ K018
	06/03→		Knorr		ACV062	29171		K005/ K018
SB 7000 22.5" wheels			Knorr		ACV041	29106	WL009	K005/ K018
SN 7000 22.5" wheels	06/03→		Knorr		ACV063	29167		K005/ K018

Where more than one part number is shown, use illustrations to determine correct pad fitment for the application





# Application Data

## Brake Pads, Wear Leads and Fitting Kits

# ANL Braking



WL

K

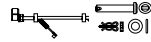

### KNORR - BREMSEN – cont.

ACV006

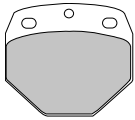

140.0 × 121.0 × 32

ACV012

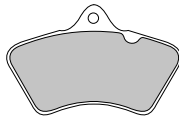

192 × 114 × 20

ACV038

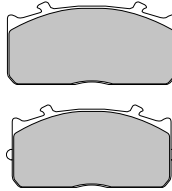

173.6 × 84 × 34.00/27.00

ACV041

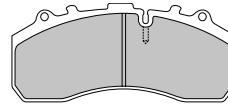

248.0 × 108.0 × 30

ACV043

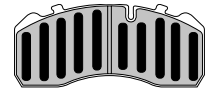

210.7 × 92.5 × 30

ACV061



210 × 92 × 29

ACV062

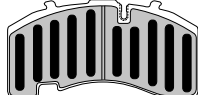

210 × 108 × 29

ACV063

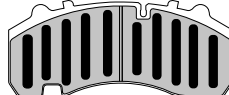

247 × 110 × 29

### LAND ROVER

90 / Defender (→4/93)

Note: ① RHD to axle 22L09654, and from 22L10192 to 22L10271,  
① LHD to axle 23L05987, and from 23L06060 to 23L06078  
Note: ② RHD from axle 22L09655, to 22L10191 and from 22L10272,  
LHD from axle 23L05988 to axle 23L06059 and from 23L06079

F 01/84–01/86  
F 01/86–01/90  
F 01/86–01/90

Lockheed  
Lockheed  
Lockheed



298  
298  
298

ADB0319①  
ADB0401 ②  
ADB11055 ③

20359  
21459  
21459

90 / Defender (→4/93)

Petrol 4 cyl

F 01/90–04/93  
F 01/90–04/93

Lockheed  
Lockheed



298  
298

ADB0401  
ADB11055

21459  
21459

90 / Defender (→4/93)

Petrol V8

F 01/90–04/93

Lockheed



298

ADB01052

21519

90 / Defender (→4/93)

Diesel 4 cyl

F 01/90–12/90  
F 01/90–12/90  
F 01/91–04/93

Lockheed  
Lockheed  
Lockheed



298  
298  
298

ADB0401  
ADB11055  
ADB01052

21459  
21459  
21519

90 / Defender (4/93→)

all models

F 04/93→  
F 04/93→

Lockheed  
Lockheed



298  
298

ADB01052  
ADB01052

21519  
21519

R 04/93→

Lockheed



291

ADB0224

20344

110, 130 / Defender (→4/93)

Note: ①RHD to axle 20L21632B, ① LHD to axle 20L18648B  
Note: ②RHD from axle 20L21633B, LHD from axle 20L18649B

F 01/83–01/87  
F 01/87–04/93

Lockheed  
Lockheed



298  
298

ADB01066①  
ADB01052 ②

20904  
21519

Where more than one part number is shown, use illustrations to determine correct pad fitment for the application



# Application Data

## Brake Pads, Wear Leads and Fitting Kits

# ANL

## Braking

						ACV/ADB	WVA	WL	K
						mm	NO.		
<b>LAND ROVER – cont.</b> 110, 130 / Defender (4/93→)	F	04/93→	Lockheed		298	<b>ADB01052</b>	21519		
	R	04/93→	Lockheed		290	<b>ADB01078</b>	23471		
<b>Discovery (→4/93)</b>	F	01/89–04/93	Lockheed		298	<b>ADB0319</b>	20359		
	F	01/89–04/93	Lockheed		298	<b>ADB1413</b>	20359		
	F	01/89–04/93	Lockheed		298	<b>ADB0401</b>	21459		
	F	01/89–04/93	Lockheed		298	<b>ADB11055</b>	21459		
	R	01/89–04/93	Lockheed		291	<b>ADB1224</b>	20344		
<b>Discovery (4/93→10/99)</b>	F	04/93–10/99	Lockheed		298	<b>ADB0401</b>	21459		
	F	04/93–10/99	Lockheed		298	<b>ADB11055</b>	21459		
	F	04/93–10/99	Lockheed		298	<b>ADB0401</b>	21459		
	F	04/93–10/99	Lockheed		298	<b>ADB11055</b>	21459		
	R	04/93–10/99	Lockheed		291	<b>ADB0224</b>	20344		
<b>Discovery (10/99→)</b> 2.0i 16V	F	10/99→	Lucas		297	<b>ADB0162</b>	23452		
	R	10/99→	Lucas		304	<b>ADB01093</b>	23458		
<b>Discovery (10/99→)</b> 2.5 Tdi	F	10/99→	Lucas		297	<b>ADB0162</b>	23452		
	R	10/99→	Lucas		304	<b>ADB01093</b>	23458		
<b>Discovery (10/99→)</b> 3.9i 16V	F	10/99→	Lucas		297	<b>ADB0162</b>	23452		
	R	10/99→	Lucas		304	<b>ADB01093</b>	23458		
<b>Freelander (→10/00)</b> 1.8i	F	10/97–10/00	Lucas		261	<b>ADB0232</b>	21515		
	F	10/97–10/00	Lucas		261	<b>ADB3232</b>	21515		
<b>Freelander (→10/00)</b> 2.0 Turbo Diesel	F	10/97–10/00	Lucas		261	<b>ADB0232</b>	21515		
	F	10/97–10/00	Lucas		261	<b>ADB3232</b>	21515		
<b>Freelander 10/00→)</b> 1.8i	F	10/00→	Lucas			<b>ADB0873</b>	23615		
<b>Freelander 10/00→)</b> 2.0 Turbo Diesel	F	10/00→	Lucas			<b>ADB0873</b>	23615		
<b>Freelander 10/00→)</b> 2.5i V6	F	10/00→	Lucas			<b>ADB0873</b>	23615		
<b>Range Rover (Classic)</b> 2.4D, 3.5 V8, 3.9i V8	F	01/70–11/85	Lockheed		298	<b>ADB0319</b>	20359		
	F	11/85–01/96	Lockheed		298	<b>ADB0319</b>	20359		
	F	11/85–01/96	Lockheed		298	<b>ADB1413</b>	20359		
	F	08/89–01/96	Lockheed		298	<b>ADB11055</b>	21459		
	R	01/70–11/85	Lockheed		290	<b>ADB0224</b>	20344		
	R	11/85–01/96	Lockheed		291	<b>ADB0224</b>	20344		
	R	11/85–01/96	Lockheed		291	<b>ADB1224</b>	20344		

Where more than one part number is shown, use illustrations to determine correct pad fitment for the application



# Application Data

## Brake Pads, Wear Leads and Fitting Kits

# ANL Braking

						ACV/ADB	WVA NO.	WL	K															
						mm																		
<b>LAND ROVER – cont.</b>																								
<b>Range Rover (→03/02)</b> 2.5 TD, 4.0 V8, 4.6 V8																								
F	01/94–03/02	Lucas		297	<b>ADB0162</b>	23452																		
R	01/94–03/02	Lucas		304	<b>ADB01093</b>	23458																		
<b>Range Rover (03/02→)</b> 3.0 TD6																								
F	03/02→	Ate			<b>ADB01157</b>																			
R	03/02→	Ate				21487																		
<b>Range Rover (03/02→)</b> 4.4i V8																								
F	03/02→	Ate			<b>ADB01157</b>																			
R	03/02→	Ate				21487																		
<b>Range Rover (03/02→)</b> 4.6i V8																								
F	03/02→	Ate			<b>ADB01157</b>																			
R	03/02→	Ate				21487																		
<table border="0" style="width:100%; text-align:center;"> <tr> <td><b>ADB0162</b></td> <td><b>ADB0224</b></td> <td><b>ADB0232</b></td> <td><b>ADB0319</b></td> <td><b>ADB0401</b></td> </tr> <tr> <td></td> <td></td> <td></td> <td></td> <td></td> </tr> <tr> <td>144.8 × 66.5 × 18</td> <td>88.7 × 72.0 × 15</td> <td>130.0 × 69 × 17.5</td> <td>104.9 × 74.7 × 18</td> <td>104.9 × 72.4 × 18</td> </tr> </table>										<b>ADB0162</b>	<b>ADB0224</b>	<b>ADB0232</b>	<b>ADB0319</b>	<b>ADB0401</b>						144.8 × 66.5 × 18	88.7 × 72.0 × 15	130.0 × 69 × 17.5	104.9 × 74.7 × 18	104.9 × 72.4 × 18
<b>ADB0162</b>	<b>ADB0224</b>	<b>ADB0232</b>	<b>ADB0319</b>	<b>ADB0401</b>																				
144.8 × 66.5 × 18	88.7 × 72.0 × 15	130.0 × 69 × 17.5	104.9 × 74.7 × 18	104.9 × 72.4 × 18																				
<table border="0" style="width:100%; text-align:center;"> <tr> <td><b>ADB0873</b></td> <td><b>ADB01052</b></td> <td><b>ADB01066</b></td> <td><b>ADB01078</b></td> <td><b>ADB01093</b></td> </tr> <tr> <td></td> <td></td> <td></td> <td></td> <td></td> </tr> <tr> <td>131.4 × 62 × 17.5</td> <td>126.8 × 68.5 × 18</td> <td>126.7 × 71.2 × 18</td> <td>85.0 × 75.0 × 14.5</td> <td>95.0 × 52.0 × 15.5</td> </tr> </table>										<b>ADB0873</b>	<b>ADB01052</b>	<b>ADB01066</b>	<b>ADB01078</b>	<b>ADB01093</b>						131.4 × 62 × 17.5	126.8 × 68.5 × 18	126.7 × 71.2 × 18	85.0 × 75.0 × 14.5	95.0 × 52.0 × 15.5
<b>ADB0873</b>	<b>ADB01052</b>	<b>ADB01066</b>	<b>ADB01078</b>	<b>ADB01093</b>																				
131.4 × 62 × 17.5	126.8 × 68.5 × 18	126.7 × 71.2 × 18	85.0 × 75.0 × 14.5	95.0 × 52.0 × 15.5																				
<table border="0" style="width:100%; text-align:center;"> <tr> <td><b>ADB01157</b></td> <td><b>ADB1224</b></td> <td><b>ADB1413</b></td> <td><b>ADB3232</b></td> <td><b>ADB11055</b></td> </tr> <tr> <td></td> <td></td> <td></td> <td></td> <td></td> </tr> <tr> <td>156.4/155.4 × 73.5 × 19</td> <td>88.7 × 72.0 × 15</td> <td>104.9 × 74.7 × 18</td> <td>130.0 × 69 × 17.5</td> <td>104.9 × 72.4 × 18</td> </tr> </table>										<b>ADB01157</b>	<b>ADB1224</b>	<b>ADB1413</b>	<b>ADB3232</b>	<b>ADB11055</b>						156.4/155.4 × 73.5 × 19	88.7 × 72.0 × 15	104.9 × 74.7 × 18	130.0 × 69 × 17.5	104.9 × 72.4 × 18
<b>ADB01157</b>	<b>ADB1224</b>	<b>ADB1413</b>	<b>ADB3232</b>	<b>ADB11055</b>																				
156.4/155.4 × 73.5 × 19	88.7 × 72.0 × 15	104.9 × 74.7 × 18	130.0 × 69 × 17.5	104.9 × 72.4 × 18																				

Where more than one part number is shown, use illustrations to determine correct pad fitment for the application











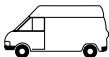
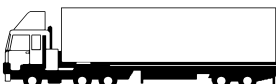







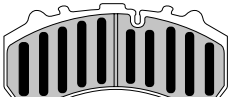





# Application Data

## Brake Pads, Wear Leads and Fitting Kits

# ANL

## Braking

					 mm				
<b>LECINENA</b>									
with Knorr brakes SB 7000			01/98→	Knorr		ACV042	29108		K005/ K018
<p><b>ACV042</b></p>  <p>248.0 × 108.0 × 30</p>									
<b>L.D.V (LEYLAND DAF VANS)</b>									
<b>Light commercials</b>									
<b>Sherpa (→85)</b> 215, 220, 240, 250	F	01/80–01/85	Lockheed		276	<b>ADB0239</b>	20364		
<b>Sherpa (→85)</b> 280, Combi	F	01/80–01/83	Lockheed		276	<b>ADB0319</b>	20359		
<b>Sherpa (→85)</b> 285, 310, 350, Combi	F	01/83–01/85	Lockheed		276	<b>ADB0319</b>	20359		
<b>200 Series (→89)</b> 200, 230, 250, 255	F	01/85–01/89	Lockheed		276	<b>ADB0239</b>	20364		
<b>200 Series (→89)</b> 280, Combi, PSV	F	01/85–01/89	Lockheed		276	<b>ADB0319</b>	20359		
<b>300 Series (→89)</b> 285, 300, 310, 350 4 x 41mm caliper pistons 4 x 46mm caliper pistons	F	01/85–01/89	Lockheed		276	<b>ADB0319</b>	20359		
	F	01/85–01/89	Lockheed		275	<b>ADB01066</b>	20904		
<b>400 Series (→89)</b> 2.8t, 3.1t, 3.5t, Combi, PSV 4 x 41mm caliper pistons 4 x 46mm caliper pistons	F	01/85–01/89	Lockheed		276	<b>ADB0319</b>	20359		
	F	01/85–01/89	Lockheed		275	<b>ADB01066</b>	20904		
<b>200 Series (89-94)</b> 2.0t, 2.3t, 2.5t	F	01/89–01/94	Lockheed		276	<b>ADB0239</b>	20364		
<b>200 Series (89-94)</b> 2.8t, Combi, PSV	F	01/89–01/94	Lockheed		276	<b>ADB0319</b>	20359		
<b>400 Series (89-94)</b> 2.8t, 3.1t, 3.5t, Combi, PSV 4 x 41mm caliper pistons 4 x 46mm caliper pistons	F	01/89–01/94	Lockheed		276	<b>ADB0319</b>	20359		
	F	01/89–01/94	Lockheed		275	<b>ADB01066</b>	20904		



























Where more than one part number is shown, use illustrations to determine correct pad fitment for the application



# Application Data

## Brake Pads, Wear Leads and Fitting Kits

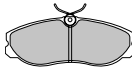
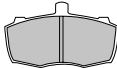
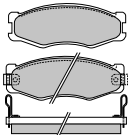
# ANL Braking

						ACV/ADB	WVA NO.	WL	K
									
<b>L.D.V – cont.</b> Convoy (400 Series 94→) 2.8t, 3.1t Chassis Cab, Crew Bus standard duty (4x41mm caliper pistons) heavy duty (4x46mm caliper pistons)	F	01/94→	Lockheed		276	<b>ADB0319</b>	20359		
	F	01/94→	Lockheed		275	<b>ADB01066</b>	20904		
<b>Convoy (400 Series 94→)</b> 2.8t, 3.1t, 3.3t, 3.5t Ambulance, Mini Bus standard duty (4x41mm caliper pistons) heavy duty (4x46mm caliper pistons)	F	01/94→	Lockheed		276	<b>ADB0319</b>	20359		
	F	01/94→	Lockheed		275	<b>ADB01066</b>	20904		
<b>Convoy (400 Series 94→)</b> 4.1t Chassis Cab, Recovery vehicle	F	01/94→	Lockheed		275	<b>ADB01066</b>	20904		
<b>Cub</b> 2.3 D	F	01/98→	Akebono		257	<b>ADB0177</b>	21099		
	F	01/98→	Akebono		257	<b>ADB3387</b>	21119		
	F	01/98→	Lucas		257	<b>ADB0447</b>	21481		
<b>Pilot (200 Series 94→)</b> 2.0t, 2.3t, 2.5t (Petrol and Diesel) 2 x 57mm caliper pistons 4 x 41mm caliper pistons	F	01/94→	Lockheed		276	<b>ADB0239</b>	20364		
	F	01/94→	Lockheed		276	<b>ADB0319</b>	20359		
<b>Pilot (200 Series 94→)</b> 2.3t, 2.5t, 2.8t Mini Bus (Petrol and Diesel)	F	01/94→	Lockheed		276	<b>ADB0319</b>	20359		
<b>Pilot (200 Series 94→)</b> 2.8t Chassis Cab, Crew Bus (Petrol and Diesel)	F	01/94→	Lockheed		276	<b>ADB0319</b>	20359		
<b>ADB0177</b>	<b>ADB0239</b>	<b>ADB0319</b>	<b>ADB0447</b>	<b>ADB01066</b>					
									
129.9 × 49.0 × 17	88.5 × 70.9 × 15	104.9 × 74.7 × 18	144.0 × 56.0 × 15.5	126.7 × 71.2 × 18					
<b>ADB3387</b>									
									
129.9 × 49.0 × 17									
<b>LIAZ</b>									
<b>400 Series</b>	F	01/98→	Knorr		430	<b>ACV041</b>	29106	<b>WL009</b>	<b>K005/ K018</b>

Where more than one part number is shown, use illustrations to determine correct pad fitment for the application



# Application Data

## Brake Pads, Wear Leads and Fitting Kits

# ANL

## Braking

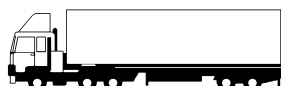

WL

K

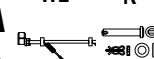

### LIAZ – cont.

ACV041

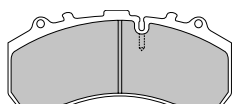

248.0 × 108.0 × 30

### MAN

19.502 F, FL, FS

F 01/89→  
F 01/89→

Meritor (Lucas)  
Meritor (Lucas)

438  
 438

ACV014<sup>①</sup> 29030  
ACV030<sup>②</sup> 29053

K002/  
K016  
K013/  
K016

Note: Disc Th 45→41mm use <sup>①</sup>, 41→38mm use <sup>②</sup>

25.502 DF, DFS

F 01/89→  
F 01/89→

Meritor (Lucas)  
Meritor (Lucas)

438  
 438

ACV014<sup>①</sup> 29030  
ACV030<sup>②</sup> 29053

K002/  
K016  
K013/  
K016

Note: Disc Th 45→41mm use <sup>①</sup>, 41→38mm use <sup>②</sup>

26.502 DF, DFS

F 01/89→  
F 01/89→

Meritor (Lucas)  
Meritor (Lucas)

438  
 438

ACV014<sup>①</sup> 29030  
ACV030<sup>②</sup> 29053

K002/  
K016  
K013/  
K016

Note: Disc Th 45→41mm use <sup>①</sup>, 41→38mm use <sup>②</sup>

26.502 FNL

F 01/89→  
F 01/89→

Meritor (Lucas)  
Meritor (Lucas)

438  
 438

ACV014<sup>①</sup> 29030  
ACV030<sup>②</sup> 29053

K002/  
K016  
K013/  
K016

Note: Disc Th 45→41mm use <sup>①</sup>, 41→38mm use <sup>②</sup>

27.502 DF, DFS

F 01/89→  
F 01/89→

Meritor (Lucas)  
Meritor (Lucas)

438  
 438

ACV014<sup>①</sup> 29030  
ACV030<sup>②</sup> 29053

K002/  
K016  
K013/  
K016

Note: Disc Th 45→41mm use <sup>①</sup>, 41→38mm use <sup>②</sup>

33.502 DF, DFS

F 01/89→  
F 01/89→

Meritor (Lucas)  
Meritor (Lucas)

438  
 438

ACV014<sup>①</sup> 29030  
ACV030<sup>②</sup> 29053

K002/  
K016  
K013/  
K016

Note: Disc Th 45→41mm use <sup>①</sup>, 41→38mm use <sup>②</sup>

Where more than one part number is shown, use illustrations to determine correct pad fitment for the application



# Application Data

## Brake Pads, Wear Leads and Fitting Kits

# ANL Braking

						ACV/ADB	WVA NO.	WL	K
					mm				
<b>MAN – cont.</b> 48.502 VF	F	01/89→	Meritor (Lucas)		438	ACV014 <sup>①</sup>	29030		K002/ K016 K013/ K016
	F	01/89→	Meritor (Lucas)		438	ACV030 <sup>②</sup>	29053		
<b>Note: Disc Th 45→41mm use ①, 41→38mm use ②</b>									
<b>F90 Series</b> 17 T → 19 T Series	F	01/89–01/96	Meritor (Lucas)		432	ACV014 <sup>①</sup>	29030	WL003	K002/ K016 K013/ K016
	F	01/89–01/96	Meritor (Lucas)		432	ACV030 <sup>②</sup>	29053	WL003	
<b>Note: Disc Th 45→41mm use ①, 41→38mm use ②</b>									
<b>F90 Series</b> 22 T → 27 T Series	F	01/89–01/96	Meritor (Lucas)		432	ACV014 <sup>①</sup>	29030	WL003	K002/ K016 K013/ K016
	F	01/89–01/96	Meritor (Lucas)		432	ACV030 <sup>②</sup>	29053	WL003	
<b>Note: Disc Th 45→41mm use ①, 41→38mm use ②</b>									
<b>F90 Series</b> 30 T → 33 T Series	F	01/89–01/96	Meritor (Lucas)		432	ACV014 <sup>①</sup>	29030	WL003	K002/ K016 K013/ K016
	F	01/89–01/96	Meritor (Lucas)		432	ACV030 <sup>②</sup>	29053	WL003	
<b>Note: Disc Th 45→41mm use ①, 41→38mm use ②</b>									
<b>F2000 Series</b> 17 T → 19 T Series	F	01/95–04/02	Meritor (Lucas)		438	ACV014 <sup>①</sup>	29030	WL003	K002/ K016 K013/ K016
	F	01/95–04/02	Meritor (Lucas)		438	ACV030 <sup>②</sup>	29053	WL003	
<b>Note: Disc Th 45→41mm use ①, 41→38mm use ②</b>									
<b>F2000 Series</b> 22 T → 27 T Series	F	01/95–04/02	Meritor (Lucas)		438	ACV014 <sup>①</sup>	29030	WL003	K002/ K016 K013/ K016
	F	01/95–04/02	Meritor (Lucas)		438	ACV030 <sup>②</sup>	29053	WL003	
<b>Note: Disc Th 45→41mm use ①, 41→38mm use ②</b>									
<b>F2000 Series</b> 30 T → 35 T Series	F	01/99→	Meritor (Lucas)		438	ACV014 <sup>①</sup>	29030	WL003	K002/ K016 K013/ K016
	F	01/99→	Meritor (Lucas)		438	ACV030 <sup>②</sup>	29053	WL003	
<b>Note: Disc Th 45→41mm use ①, 41→38mm use ②</b>									
<b>F2000 Series</b> 40 T Series	F	01/95–04/02	Meritor (Lucas)		438	ACV014 <sup>①</sup>	29030	WL003	K002/ K016 K013/ K016
	F	01/95–04/02	Meritor (Lucas)		438	ACV030 <sup>②</sup>	29053	WL003	
<b>Note: Disc Th 45→41mm use ①, 41→38mm use ②</b>									
<b>L2000 Series</b> 6.103 → 10.224	F	11/93–01/96	Wabco / Perrot		324	ACV025 <sup>①</sup>	29055	WL015	K006 K006 -cont.
	F	01/96→	Wabco / Perrot		330	ACV039 <sup>②</sup>	29088	WL032	
	F	01/96→	Wabco / Perrot		330	ACV040 <sup>③</sup>	29091	WL032	

Where more than one part number is shown, use illustrations to determine correct pad fitment for the application



# Application Data

## Brake Pads, Wear Leads and Fitting Kits

# ANL Braking

MAN – cont. L2000 Series – cont.									
<b>Note:</b> ① Replaced by ACV032, see Technical Bulletin #001 <b>Note:</b> Disc Th 30→26mm use ②, 26→24mm use ③	R	01/96→	Wabco / Perrot		330	ACV039 <sup>②</sup>	29088	WL032	K006
	R	01/96→	Wabco / Perrot		330	ACV040 <sup>③</sup>	29091	WL032	K006
<b>M90 Series</b> 12.192 F 4x2 Rigid	F	01/89–01/96	Meritor (Lucas)		432	ACV014	29030		K002/ K016
<b>M90 Series</b> 14.192 F 4x2 Rigid	F	01/89–01/96	Meritor (Lucas)		432	ACV014	29030		K002/ K016
<b>M90 Series</b> 17.192, 17.232 F, FD 4x2 Chassis Cab, Drawbar	F	01/89–01/98	Meritor (Lucas)		432	ACV014	29030		K002/ K016
<b>M2000 Series</b> 12 Series 12T GVW	F	11/96→	Wabco / Perrot		330	ACV039 <sup>①</sup>	29088	WL032	K006
	F	11/96→	Wabco / Perrot		330	ACV040 <sup>②</sup>	29091	WL032	K006
	R	11/96→	Wabco / Perrot		330	ACV039 <sup>①</sup>	29088	WL032	K006
	R	11/96→	Wabco / Perrot		330	ACV040 <sup>②</sup>	29091	WL032	K006
<b>Note:</b> Disc Th 30→26mm use ①, 26→24mm use ②									
<b>M2000 Series</b> 14 Series 14T GVW  33T GCW	F	11/96→	Knorr		377	ACV036 <sup>①</sup>	29093	WL015	K005/ K018
	F	11/96→	Knorr		377	ACV037 <sup>②</sup>	29095	WL015	K005/ K018
	F	11/96→	Knorr		377	ACV036 <sup>①</sup>	29093	WL015	K005/ K018
	F	11/96→	Knorr		377	ACV037 <sup>②</sup>	29095	WL015	K005/ K018
<b>Note:</b> Disc Th 45→41mm use ①, 41→38mm use ②									
<b>M2000 Series</b> 15 Series 15T GVW	F	11/96→	Meritor (Lucas)		432	ACV014 <sup>①</sup>	29030	WL003	K002/ K016
	F	11/96→	Meritor (Lucas)		432	ACV030 <sup>②</sup>	29053	WL003	K013/ K016
<b>Note:</b> Disc Th 45→41mm use ①, 41→38mm use ②									
<b>M2000 Series</b> 18 Series 17T GVW  36T GCW	F	11/96→	Meritor (Lucas)		432	ACV014 <sup>①</sup>	29030	WL003	K002/ K016
	F	11/96→	Meritor (Lucas)		432	ACV030 <sup>②</sup>	29053	WL003	K013/ K016
	F	11/96→	Meritor (Lucas)		432	ACV014 <sup>①</sup>	29030	WL003	K002/ K016
	F	11/96→	Meritor (Lucas)		432	ACV030 <sup>②</sup>	29053	WL003	K013/ K016
<b>Note:</b> Disc Th 45→41mm use ①, 41→38mm use ②									

Where more than one part number is shown, use illustrations to determine correct pad fitment for the application





# Application Data

## Brake Pads, Wear Leads and Fitting Kits

# ANL Braking

						ACV/ADB	WVA NO.	WL	K
<b>MAN – cont.</b> M2000 Series 23 Series 23T GVW	F	11/96→	Meritor (Lucas)		432	ACV014 <sup>①</sup>	29030	WL003	K002/ K016
	F	11/96→	Meritor (Lucas)		432	ACV030 <sup>②</sup>	29053	WL003	K013/ K016
<b>Note: Disc Th 45→41mm use ①, 41→38mm use ②</b>									
<b>M2000 Series</b> 25 Series 25T GVW	F	11/96→	Meritor (Lucas)		432	ACV014 <sup>①</sup>	29030	WL003	K002/ K016
	F	11/96→	Meritor (Lucas)		432	ACV030 <sup>②</sup>	29053	WL003	K013/ K016
<b>Note: Disc Th 45→41mm use ①, 41→38mm use ②</b>									
<b>M2000 Series</b> 26 Series 26T GVW	F	11/96→	Meritor (Lucas)		432	ACV014 <sup>①</sup>	29030	WL003	K002/ K016
	F	11/96→	Meritor (Lucas)		432	ACV030 <sup>②</sup>	29053	WL003	K013/ K016
<b>Note: Disc Th 45→41mm use ①, 41→38mm use ②</b>									
<b>PSV City Bus</b> 11.220 HOCL 19.5" wheels	F	01/98→	Knorr		377	ACV036 <sup>①</sup>	29093	WL015	K005/ K018
	F	01/98→	Knorr		377	ACV037 <sup>②</sup>	29095	WL015	K005/ K018
	R	01/98→	Knorr		377	ACV036 <sup>①</sup>	29093	WL015	K005/ K018
	R	01/98→	Knorr		377	ACV037 <sup>②</sup>	29095	WL015	K005/ K018
<b>Note: Disc Th 45→41mm use ①, 41→38mm use ②</b>									
<b>PSV City Bus</b> 14.220 HOCL 22.5" wheels	F	01/89–01/96	Meritor (Lucas)		432	ACV014 <sup>①</sup>	29030	WL003	K002/ K016
	F	01/89–01/96	Meritor (Lucas)		432	ACV030 <sup>②</sup>	29053	WL003	K013/ K016
	R	01/89–01/96	Meritor (Lucas)		432	ACV014 <sup>①</sup>	29030	WL003	K002/ K016
	R	01/89–01/96	Meritor (Lucas)		432	ACV030 <sup>②</sup>	29053	WL003	K013/ K016
<b>Note: Disc Th 45→41mm use ①, 41→38mm use ②</b>									
<b>PSV City Bus</b> 18.350 HOCL 22.5" wheels	F	01/89–01/96	Meritor (Lucas)		432	ACV014 <sup>①</sup>	29030	WL003	K002/ K016
	F	01/89–01/96	Meritor (Lucas)		432	ACV030 <sup>②</sup>	29053	WL003	K013/ K016
<b>Note: Disc Th 45→41mm use ①, 41→38mm use ②</b>									



























Where more than one part number is shown, use illustrations to determine correct pad fitment for the application



# Application Data

## Brake Pads, Wear Leads and Fitting Kits

# ANL Braking

											
<b>MAN – cont.</b> PSV City Bus EL Series 22.5" wheels	F	01/93→	Meritor (Lucas)		432	ACV014 <sup>①</sup>	29030	WL003	K002/ K016		
	F	01/93→	Meritor (Lucas)		432	ACV030 <sup>②</sup>	29053	WL003	K013/ K016		
Note: Disc Th 45→41mm use <sup>①</sup> , 41→38mm use <sup>②</sup>											
PSV City Bus NG Series 22.5" wheels	F	01/89–01/96	Meritor (Lucas)		432	ACV014 <sup>①</sup>	29030	WL003	K002/ K016		
	F	01/89–01/96	Meritor (Lucas)		432	ACV030 <sup>②</sup>	29053	WL003	K013/ K016		
Note: Disc Th 45→41mm use <sup>①</sup> , 41→38mm use <sup>②</sup>											
PSV City Bus NL Series 22.5" wheels	F	01/89–01/96	Meritor (Lucas)		432	ACV014 <sup>①</sup>	29030	WL003	K002/ K016		
	F	01/89–01/96	Meritor (Lucas)		432	ACV030 <sup>②</sup>	29053	WL003	K013/ K016		
Note: Disc Th 45→41mm use <sup>①</sup> , 41→38mm use <sup>②</sup>											
PSV City Bus NU Series 22.5" wheels	F	01/89→	Meritor (Lucas)		432	ACV014 <sup>①</sup>	29030	WL003	K002/ K016		
	F	01/89→	Meritor (Lucas)		432	ACV030 <sup>②</sup>	29053	WL003	K013/ K016		
Note: Disc Th 45→41mm use <sup>①</sup> , 41→38mm use <sup>②</sup>											
PSV City Bus UL Series 22.5" wheels	F	01/89→	Meritor (Lucas)		432	ACV014 <sup>①</sup>	29030	WL003	K002/ K016		
	F	01/89→	Meritor (Lucas)		432	ACV030 <sup>②</sup>	29053	WL003	K013/ K016		
Note: Disc Th 45→41mm use <sup>①</sup> , 41→38mm use <sup>②</sup>											
PSV Lion's Coach NG Series 22.5" wheels	F	01/89–01/96	Meritor (Lucas)		432	ACV014 <sup>①</sup>	29030	WL003	K002/ K016		
	F	01/89–01/96	Meritor (Lucas)		432	ACV030 <sup>②</sup>	29053	WL003	K013/ K016		
Note: Disc Th 45→41mm use <sup>①</sup> , 41→38mm use <sup>②</sup>											
PSV Lion's Comfort NG Series 22.5" wheels	F	01/89–01/96	Meritor (Lucas)		432	ACV014 <sup>①</sup>	29030	WL003	K002/ K016		
	F	01/89–01/96	Meritor (Lucas)		432	ACV030 <sup>②</sup>	29053	WL003	K013/ K016		
Note: Disc Th 45→41mm use <sup>①</sup> , 41→38mm use <sup>②</sup>											
PSV Lion's Star 403, 422 FRH 22.5" wheels	F	01/93–01/96	Knorr		438	ACV006	29747		K001		
	F	01/93→	Meritor (Lucas)		438	ACV014 <sup>①</sup>	29030	WL003	K002/ K016		
Note: Disc Th 45→41mm use <sup>①</sup> , 41→38mm use <sup>②</sup>											

Where more than one part number is shown, use illustrations to determine correct pad fitment for the application



# Application Data

## Brake Pads, Wear Leads and Fitting Kits

# ANL Braking

						ACV/ADB	WVA NO.	WL	K
					mm				
<b>MAN – cont.</b> PSV SG, SL (150 → 190 Series)	F	11/93–01/96	Wabco / Perrot		324	ACV025 <sup>①</sup>	29055	WL015	
	F	01/96→	Wabco / Perrot		330	ACV039 <sup>②</sup>	29088	WL032	K006
	F	01/96→	Wabco / Perrot		330	ACV040 <sup>③</sup>	29091	WL032	K006
	R	01/96→	Wabco / Perrot		330	ACV039 <sup>②</sup>	29088	WL032	K006
	R	01/96→	Wabco / Perrot		330	ACV040 <sup>③</sup>	29091	WL032	K006
	Note: <sup>①</sup> Replaced by ACV032, see Technical Bulletin #001 Note: Disc Th 30→26mm use <sup>②</sup> , 26→24mm use <sup>③</sup>								
PSV SG, SL (230 → 750 Series)	F	11/93–01/96	Wabco / Perrot		324	ACV025 <sup>①</sup>	29055	WL015	
	F	01/96→	Wabco / Perrot		330	ACV039 <sup>②</sup>	29088	WL032	K006
	F	01/96→	Wabco / Perrot		330	ACV040 <sup>③</sup>	29091	WL032	K006
	R	01/96→	Wabco / Perrot		330	ACV039 <sup>②</sup>	29088	WL032	K006
	R	01/96→	Wabco / Perrot		330	ACV040 <sup>③</sup>	29091	WL032	K006
	Note: <sup>①</sup> Replaced by ACV032, see Technical Bulletin #001 Note: Disc Th 30→26mm use <sup>②</sup> , 26→24mm use <sup>③</sup>								
PSV SU 210	F	11/93–01/96	Wabco / Perrot		324	ACV025 <sup>①</sup>	29055	WL015	
	F	01/96→	Wabco / Perrot		330	ACV039 <sup>②</sup>	29088	WL032	K006
	F	01/96→	Wabco / Perrot		330	ACV040 <sup>③</sup>	29091	WL032	K006
	R	01/96→	Wabco / Perrot		330	ACV039 <sup>②</sup>	29088	WL032	K006
	R	01/96→	Wabco / Perrot		330	ACV040 <sup>③</sup>	29091	WL032	K006
	Note: <sup>①</sup> Replaced by ACV032, see Technical Bulletin #001 Note: Disc Th 30→26mm use <sup>②</sup> , 26→24mm use <sup>③</sup>								
PSV SU 230	F	11/93–01/96	Wabco / Perrot		324	ACV025 <sup>①</sup>	29055	WL015	
	F	01/96→	Wabco / Perrot		330	ACV039 <sup>②</sup>	29088	WL032	K006
	F	01/96→	Wabco / Perrot		330	ACV040 <sup>③</sup>	29091	WL032	K006
	R	01/96→	Wabco / Perrot		330	ACV039 <sup>②</sup>	29088	WL032	K006
	R	01/96→	Wabco / Perrot		330	ACV040 <sup>③</sup>	29091	WL032	K006
	Note: <sup>①</sup> Replaced by ACV032, see Technical Bulletin #001 Note: Disc Th 30→26mm use <sup>②</sup> , 26→24mm use <sup>③</sup>								
TG-A 18 Series 310→510	F	03/00→	Meritor (Lucas)		432	ACV058	29131	WL011	K002
	R	03/00→	Meritor (Lucas)		432	ACV058	29131	WL011	K002
TG-A 26 Series 360→510	F	03/00→	Meritor (Lucas)		432	ACV058	29131	WL011	K002
	R	03/00→	Meritor (Lucas)		432	ACV058	29131	WL011	K002
TG-A 33 Series 460→510	F	03/00→	Meritor (Lucas)		432	ACV058	29131	WL011	K002
	R	03/00→	Meritor (Lucas)		432	ACV058	29131	WL011	K002

Where more than one part number is shown, use illustrations to determine correct pad fitment for the application



# Application Data

## Brake Pads, Wear Leads and Fitting Kits

# ANL Braking



WL

K

### MAN – cont.

ACV006

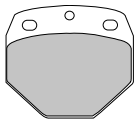

140.0 × 121.0 × 32

ACV014

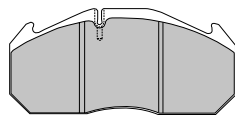

250.0 × 118.0 × 28

ACV025

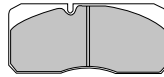

176.0 × 83.0 × 22

ACV030

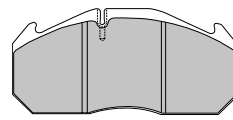

250.0 × 118.0 × 28

ACV036

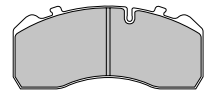

210.7 × 92.5 × 30

ACV037

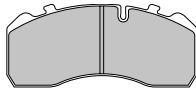

210.7 × 92.5 × 30

ACV039

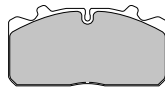

175.6 × 85.6 × 26

ACV040

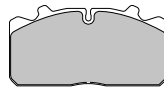

175.6 × 85.6 × 27

ACV058

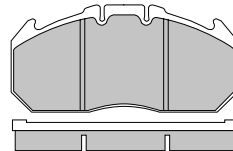

250.0 × 118.0 × 30

### MAZDA

**B Series (→02/99)**  
1.6, 1.8, - Petrol

F

01/73–01/81

Sumitomo



256

**ADB0313**

20313

F

01/81–01/85

Akebono



256

**ADB0323**

21243

**B Series (→02/99)**  
2.0

F

01/79–01/85

Akebono



256

**ADB0323**

21243

F

01/85–02/88

Akebono



256

**ADB0323**

21243

F

02/88–03/96

Sumitomo



256

**ADB3320**

**B Series (→02/99)**  
2.2 D

F

02/86–02/88

Akebono



256

**ADB0323**

21243

F

02/88–03/96

Sumitomo



256

**ADB3320**

**B Series (→02/99)**  
2.5 D 2x4

F

01/87–02/88

Akebono



256

**ADB0323**

21243

F

02/88–01/93

Sumitomo



256

**ADB3320**

F

04/96–02/99

Sumitomo



256

**ADB0733**

**B Series (→02/99)**  
2.5 D 4x4

F

01/87–02/88

Akebono



272

**ADB0323**

21243

F

02/88–01/93

Sumitomo



256

**ADB3320**

**B Series (→02/99)**  
2.6 2x4

F

01/87–02/88

Akebono



256

**ADB0323**

21243

F

02/88–01/93

Sumitomo



256

**ADB3320**

**B Series (→02/99)**  
2.6 4x4

F

01/87–02/88

Akebono



272

**ADB0323**

21243

F

02/88–01/93

Sumitomo



256

**ADB3320**

**B Series (02/99)**  
2.2 D 2x4

F

02/99→



23540

Where more than one part number is shown, use illustrations to determine correct pad fitment for the application



# Application Data

## Brake Pads, Wear Leads and Fitting Kits

# ANL Braking

						ACV/ADB	WVA NO.	WL	K															
						mm																		
<b>MAZDA – cont.</b>																								
<b>B Series (02/99)</b> 2.5 D 4x4	F	02/99→					23540																	
<b>B Series (02/99)</b> 2.6 4x4	F	02/99→					23540																	
<b>E Series</b> 1.6, 1.8, - Petrol	F	01/82–12/84	Sumitomo			256	<b>ADB0316</b>	21109																
<b>E Series</b> 2.0 - Petrol	F	01/84→	Akebono			256	<b>ADB0168</b>	20002																
	F	01/84→	Akebono			256	<b>ADB3168</b>	20002																
	F	01/84→	Akebono			268	<b>ADB0168</b>	20002																
	F	01/84→	Akebono			268	<b>ADB3168</b>	20002																
<b>E Series</b> 2.2 - Diesel	F	06/85→	Akebono			256	<b>ADB0168</b>	20002																
	F	06/85→	Akebono			256	<b>ADB3168</b>	20002																
	F	06/85→	Akebono			268	<b>ADB0168</b>	20002																
	F	06/85→	Akebono			268	<b>ADB3168</b>	20002																
<b>Econovan</b> 1.8, 2.0, 2.2	F	01/84–01/92	Akebono			256	<b>ADB0168</b>	20002																
	F	01/84–01/92	Akebono			256	<b>ADB3168</b>	20002																
	R	01/84–01/92																						
<table border="0" style="width:100%; text-align:center;"> <tr> <td><b>ADB0168</b></td> <td><b>ADB0313</b></td> <td><b>ADB0316</b></td> <td><b>ADB0323</b></td> <td><b>ADB0733</b></td> </tr> <tr> <td></td> <td></td> <td></td> <td></td> <td></td> </tr> <tr> <td>133.0 × 52.0 × 14.5</td> <td>108.9 × 52.5 × 14.3</td> <td>128.0 × 56.2 × 15.5</td> <td>127.8 × 52.2 × 14</td> <td>142 × 55 × 16</td> </tr> </table>										<b>ADB0168</b>	<b>ADB0313</b>	<b>ADB0316</b>	<b>ADB0323</b>	<b>ADB0733</b>						133.0 × 52.0 × 14.5	108.9 × 52.5 × 14.3	128.0 × 56.2 × 15.5	127.8 × 52.2 × 14	142 × 55 × 16
<b>ADB0168</b>	<b>ADB0313</b>	<b>ADB0316</b>	<b>ADB0323</b>	<b>ADB0733</b>																				
133.0 × 52.0 × 14.5	108.9 × 52.5 × 14.3	128.0 × 56.2 × 15.5	127.8 × 52.2 × 14	142 × 55 × 16																				
<table border="0" style="width:100%; text-align:center;"> <tr> <td><b>ADB3168</b></td> <td><b>ADB3320</b></td> </tr> <tr> <td></td> <td></td> </tr> <tr> <td>133.0 × 52.0 × 14.5</td> <td>127.0 × 51.0 × 15.5</td> </tr> </table>										<b>ADB3168</b>	<b>ADB3320</b>			133.0 × 52.0 × 14.5	127.0 × 51.0 × 15.5									
<b>ADB3168</b>	<b>ADB3320</b>																							
133.0 × 52.0 × 14.5	127.0 × 51.0 × 15.5																							
<b>MCW</b>																								
<b>Metro Cab</b>	F	08/91→	Lockheed			284	<b>ADB0401</b>	21459																

Where more than one part number is shown, use illustrations to determine correct pad fitment for the application



# Application Data

## Brake Pads, Wear Leads and Fitting Kits

# ANL

## Braking

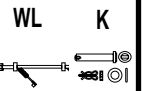

### MCW – cont.

ADB0401

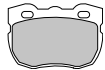

104.9 × 72.4 × 18

### MENARINI

Autobus, Autocar

F 01/95→

350

R 01/95→

350

Inbus

F 01/95→

425

Monocar  
201, 220

F →01/95

412

R →01/95

Monocar  
201, 220

F 01/95→

350

R 01/95→

350

Monocar  
5001

F 01/95→

Brembo

350

**ACV008**

29072

ACV008

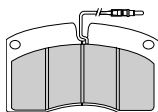

169.8 × 98.0 × 19

### MERCEDES

Actros

1831 → 2040 models  
2 axle models  
except all wheel drive

F 09/96→

Knorr

430

**ACV041**

29106

F 06/03→

Knorr

430

**ACV063**

29167

**K005/  
K018  
K005/  
K018  
-cont.**

Where more than one part number is shown, use illustrations to determine correct pad fitment for the application



# Application Data

## Brake Pads, Wear Leads and Fitting Kits

# ANL Braking

<b>MERCEDES – cont.</b> Actros – cont.	R	09/96→	Knorr		430	<b>ACV041</b>	29106		<b>K005/ K018</b>
	R	06/03→	Knorr		430	<b>ACV063</b>	29167		<b>K005/ K018</b>
<b>Actros</b> 2531 → 3353 models 3 axle models except all wheel drive	F	09/96→	Knorr		430	<b>ACV041</b>	29106		<b>K005/ K018</b>
	F	06/03→	Knorr		430	<b>ACV063</b>	29167		<b>K005/ K018</b>
1st axle	R	09/96→	Knorr		430	<b>ACV041</b>	29106		<b>K005/ K018</b>
	R	06/03→	Knorr		430	<b>ACV063</b>	29167		<b>K005/ K018</b>
2nd axle	R	09/96→	Knorr		430	<b>ACV041</b>	29106		<b>K005/ K018</b>
	R	06/03→	Knorr		430	<b>ACV063</b>	29167		<b>K005/ K018</b>
<b>Actros</b> 3231 → 4148 models 4 axle models except all wheel drive	F	09/96→	Knorr		430	<b>ACV041</b>	29106		<b>K005/ K018</b>
1st axle	F	06/03→	Knorr		430	<b>ACV063</b>	29167		<b>K005/ K018</b>
2nd axle	F	09/96→	Knorr		430	<b>ACV041</b>	29106		<b>K005/ K018</b>
	F	06/03→	Knorr		430	<b>ACV063</b>	29167		<b>K005/ K018</b>
1st axle	R	09/96→	Knorr		430	<b>ACV041</b>	29106		<b>K005/ K018</b>
	R	06/03→	Knorr		430	<b>ACV063</b>	29167		<b>K005/ K018</b>
2nd axle	R	09/96→	Knorr		430	<b>ACV041</b>	29106		<b>K005/ K018</b>
	R	06/03→	Knorr		430	<b>ACV063</b>	29167		<b>K005/ K018</b>
<b>Atego</b> 712 → 823 models except all wheel drive 17.5" wheels	F	01/98→	Knorr		335	<b>ACV038</b>	29115		<b>K005/ K018</b>
	R	01/98→	Knorr		335	<b>ACV038</b>	29115		<b>K005/ K018</b>
<b>Atego</b> 917 → 1023 models except all wheel drive 17.5" wheels	F	01/98→	Knorr		335	<b>ACV038</b>	29115		<b>K005/ K018</b> -cont.

Where more than one part number is shown, use illustrations to determine correct pad fitment for the application



# Application Data

## Brake Pads, Wear Leads and Fitting Kits

# ANL

## Braking

					ACV/ADB	WVA	WL	K
					mm	NO.		
<b>MERCEDES – cont.</b> <b>Atego – cont.</b> 19.5" wheels  17.5" wheels 19.5" wheels  <b>Note: Disc Th 45→41mm use ①, 41→38mm use ②</b>	F	01/98→	Knorr		377	ACV036①	29093	K005/ K018
	F	01/98→	Knorr		377	ACV037②	29095	K005/ K018
	R	01/98→	Knorr		335	ACV038	29115	K005/ K018
	R	01/98→	Knorr		377	ACV036①	29093	K005/ K018
	R	01/98→	Knorr		377	ACV037②	29095	K005/ K018
<b>Atego</b> 1215 → 1528 models except all wheel drive 19.5" wheels  <b>Note: Disc Th 45→41mm use ①, 41→38mm use ②</b>	F	01/98→	Knorr		377	ACV036①	29093	K005/ K018
	F	01/98→	Knorr		377	ACV037②	29095	K005/ K018
	R	01/98→	Knorr		377	ACV036①	29093	K005/ K018
	R	01/98→	Knorr		377	ACV037②	29095	K005/ K018
<b>Atego</b> 1823 → 1828 models 2 axle models 22.5" wheels	F	09/96→	Knorr		430	ACV041	29106	K005/ K018
	F	06/03→	Knorr		430	ACV063	29167	K005/ K018
	R	09/96→	Knorr		430	ACV041	29106	K005/ K018
	R	06/03→	Knorr		430	ACV063	29167	K005/ K018
<b>Atego</b> 2528 → 2628 models 3 axle models  1st axle  2nd axle	F	09/96→	Knorr		430	ACV041	29106	K005/ K018
	F	06/03→	Knorr		430	ACV063	29167	K005/ K018
	R	09/96→	Knorr		430	ACV041	29106	K005/ K018
	R	06/03→	Knorr		430	ACV063	29167	K005/ K018
	R	09/96→	Knorr		430	ACV041	29106	K005/ K018
	R	06/03→	Knorr		430	ACV063	29167	K005/ K018
<b>Axor</b> 1835→1843	F	01/02→	Knorr		430	ACV041	29106	K005/ K018
	F	06/03→	Knorr		430	ACV063	29167	K005/ K018 -cont.

Where more than one part number is shown, use illustrations to determine correct pad fitment for the application





# Application Data

## Brake Pads, Wear Leads and Fitting Kits

# ANL

## Braking

						ACV/ADB	WVA NO.	WL	K
<b>MERCEDES – cont.</b> Axor – cont.	R	01/02→	Knorr		430	ACV041	29106		K005/ K018
	R	06/03→	Knorr		430	ACV063	29167		K005/ K018
<b>Axor</b> 2535→2543	F	01/02→	Knorr		430	ACV041	29106		K005/ K018
	F	06/03→	Knorr		430	ACV063	29167		K005/ K018
	R	01/02→	Knorr		430	ACV041	29106		K005/ K018
	R	06/03→	Knorr		430	ACV063	29167		K005/ K018
<b>Econic</b> 1823→1828	F	03/98→	Knorr		430	ACV041	29106		K005/ K018
	F	06/03→	Knorr		430	ACV063	29167		K005/ K018
	R	03/98→	Knorr		430	ACV041	29106		K005/ K018
	R	06/03→	Knorr		430	ACV063	29167		K005/ K018
<b>Econic</b> 2628	F	03/98→	Knorr		430	ACV041	29106		K005/ K018
	F	06/03→	Knorr		430	ACV063	29167		K005/ K018
	R	03/98→	Knorr		430	ACV041	29106		K005/ K018
	R	06/03→	Knorr		430	ACV063	29167		K005/ K018
<b>Heavyworth Series (Powerliner)</b> 1717 (K, AK)	F	01/90–01/94	Knorr			ACV041	29106		K005/ K018
<b>Heavyworth Series (Powerliner)</b> 1820, 1827 (AK, K, L, LS)	F	01/92–12/98	Knorr			ACV041	29106		K005/ K018
<b>Heavyworth Series (Powerliner)</b> 1831, 1834, 1838 (L, LS)	F	01/92–12/98	Knorr			ACV041	29106		K005/ K018
<b>Heavyworth Series (Powerliner)</b> 1844, 1850 (LS)	F	01/92–12/98	Knorr			ACV041	29106		K005/ K018
<b>LN2 Series</b> 811 Note: ① Replaced by ACV032, see Technical Bulletin #001	F	01/87→	Meritor (Lucas)			ACV002①	29835	WL028	

Where more than one part number is shown, use illustrations to determine correct pad fitment for the application



# Application Data

## Brake Pads, Wear Leads and Fitting Kits

# ANL Braking

 	 			mm					
<b>MERCEDES – cont.</b>									
<b>MB100</b> 2.4D	F	01/80–01/89	Bendix		238	<b>ADB0991</b>	29706		
	F	01/80–01/89	Bendix		238	<b>ADB1991</b>	29984		
	F	01/89–01/96	Bendix		238	<b>ADB0183</b>	29071		
	F	01/89–01/96	Bendix		238	<b>ADB1183</b>	29985		
<b>MB100 D</b> 2.4D, 2.4 TD	F	01/87–02/96	Bendix		238	<b>ADB01089</b>	21573		
<b>MB130</b> 2.4D	F	01/80–01/89	Bendix		238	<b>ADB0991</b>	29706		
	F	01/80–01/89	Bendix		238	<b>ADB1991</b>	29984		
<b>MB130</b> 2.4D, 2.4 TD	F	01/89–01/96	Bendix		263	<b>ADB0183</b>	29071		
	F	01/89–01/96	Bendix		263	<b>ADB1183</b>	29985		
<b>PSV (Includes Evobus)</b> 307D, 308, 308D, 310	F	01/82–01/95	Wabco / Perrot		280	<b>ADB0238</b>	20784	<b>WL029</b>	
<b>PSV (Includes Evobus)</b> 0350	F	01/94→	Meritor (Lucas)		438	<b>ACV014</b> <sup>①</sup>	29030	<b>WL028</b>	<b>K002/ K016</b>
	F	01/94→	Meritor (Lucas)		438	<b>ACV030</b> <sup>②</sup>	29053	<b>WL028</b>	<b>K013/ K016</b>
	R	01/94→	Meritor (Lucas)		438	<b>ACV014</b> <sup>①</sup>	29030	<b>WL028</b>	<b>K002/ K016</b>
	R	01/94→	Meritor (Lucas)		438	<b>ACV030</b> <sup>②</sup>	29053	<b>WL028</b>	<b>K013/ K016</b>
<b>Note: Disc Th 45→41mm use ①, 41→38mm use ②</b>									
<b>PSV (Includes Evobus)</b> 0404 Neoplan (10R → 15R)	F	10/91→	Meritor (Lucas)		438	<b>ACV014</b> <sup>①</sup>	29030	<b>WL028</b>	<b>K002/ K016</b>
	F	10/91→	Meritor (Lucas)		438	<b>ACV030</b> <sup>②</sup>	29053	<b>WL028</b>	<b>K013/ K016</b>
	R	10/91→	Meritor (Lucas)		438	<b>ACV014</b> <sup>①</sup>	29030	<b>WL028</b>	<b>K002/ K016</b>
	R	10/91→	Meritor (Lucas)		438	<b>ACV030</b> <sup>②</sup>	29053	<b>WL028</b>	<b>K013/ K016</b>
<b>Note: Disc Th 45→41mm use ①, 41→38mm use ②</b>									
<b>PSV (Includes Evobus)</b> 0409	F	01/96→	Meritor (Lucas)		304	<b>ACV002</b> <sup>①</sup>	29835	<b>WL028</b>	
	R	01/96→	Meritor (Lucas)		285	<b>ACV002</b> <sup>①</sup>	29835	<b>WL028</b>	
<b>Note: ① Replaced by ACV032, see Technical Bulletin #001</b>									
<b>PSV (Includes Evobus)</b> 508D, 510, 511D	F	01/86→	Meritor (Lucas)		304	<b>ACV002</b> <sup>①</sup>	29835	<b>WL028</b>	
<b>Note: ① Replaced by ACV032, see Technical Bulletin #001</b>									
<b>PSV (Includes Evobus)</b> 608D, 609D	F	01/86→	Meritor (Lucas)		304	<b>ACV002</b> <sup>①</sup>	29835	<b>WL028</b>	
<b>Note: ① Replaced by ACV032, see Technical Bulletin #001</b>									
<b>PSV (Includes Evobus)</b> 709D, 711D 16" wheels	F	01/86–06/98	Meritor (Lucas)		304	<b>ACV002</b> <sup>①</sup>	29835	<b>WL028</b>	
	F	01/86–06/98	Meritor (Lucas)		324	<b>ACV002</b> <sup>①</sup>	29835	<b>WL028</b>	
<b>Note: ① Replaced by ACV032, see Technical Bulletin #001</b>									

Where more than one part number is shown, use illustrations to determine correct pad fitment for the application



# Application Data

## Brake Pads, Wear Leads and Fitting Kits

# ANL Braking

<b>MERCEDES – cont.</b> <b>PSV (Includes Evobus)</b> 809D, 811D, 814D 16" wheels 17.5" wheels <b>Note:</b> ① Replaced by ACV032, see Technical Bulletin #001	F	01/86–06/98	Meritor (Lucas)		324	ACV002①	29835	WL028	
	F	01/86–06/98	Meritor (Lucas)		324	ACV002①	29835	WL028	
<b>PSV (Includes Evobus)</b> Citaro 0530 except all wheel drive	F	09/96→	Knorr		430	ACV041	29106		K005/ K018
	R	09/96→	Knorr		430	ACV041	29106		K005/ K018
<b>PSV (Includes Evobus)</b> Citybus 0100	F	01/92→	Knorr		430	ACV041	29106	WL009	K005/ K018
	R	01/92→	Knorr		430	ACV041	29106	WL009	K005/ K018
<b>PSV (Includes Evobus)</b> Integro 0550 except all wheel drive	F	09/96→	Knorr		430	ACV041	29106	WL009	K005/ K018
	R	09/96→	Knorr		430	ACV041	29106	WL009	K005/ K018
<b>PSV (Includes Evobus)</b> N Series Bus NF3	F	01/92→	Knorr		430	ACV041	29106	WL009	K005/ K018
	R	01/92→	Knorr		430	ACV041	29106	WL009	K005/ K018
<b>PSV (Includes Evobus)</b> Sprinter 400 Series	F	01/00→	Bosch		276	ADB0271	29076	WL030	
	F	01/96→	Wabco / Perrot		276	ADB0271	29076	WL030	
	F	01/96→	Wabco / Perrot		276	ADB0271	29076	WL030	
	R	01/96→	Bosch		272	ADB0271	29076	WL030	
	R	01/00→	Bosch		285	ADB0271	29076	WL030	
	R	01/96→	Wabco / Perrot		258	ADB0271	29076	WL030	
<b>PSV (Includes Evobus)</b> Turismo except all wheel drive	F	01/00→	Knorr		430	ACV041	29106	WL009	K005/ K018
	R	01/00→	Knorr		430	ACV041	29106	WL009	K005/ K018

Where more than one part number is shown, use illustrations to determine correct pad fitment for the application



# Application Data

## Brake Pads, Wear Leads and Fitting Kits

# ANL Braking

<b>MERCEDES – cont.</b> <b>PSV (Includes Evobus)</b> Travego 0580 except all wheel drive	F	09/96→	Knorr		430	ACV041	29106	WL009	K005/ K018
	R	09/96→	Knorr		430	ACV041	29106	WL009	K005/ K018
<b>PSV (Includes Evobus)</b> Traveliner TL7	F	01/98→	Bosch		276	ADB0480	23022	WL030	
	R	01/98→	Bosch		280	ADB0888	23020		
<b>PSV (Includes Evobus)</b> Traveliner TL12	F	01/98→	Bosch		276	ADB0480	23022	WL030	
	R	01/98→	Bosch		280	ADB0888	23020		
<b>PSV (Includes Evobus)</b> Traveliner TL13, TL14, TL16	F	01/98→	Ate		276	ADB0212	21576	WL030	
	F	01/98→	Bosch		276	ADB0480	23022	WL030	
	R	01/98→	Ate		272	ADB0478	21592	WL030	
	R	01/98→	Bosch		258	ADB0914	23021	WL030	
<b>PSV (Includes Evobus)</b> Vario, Vario Plus 0409	F	01/96→	Meritor (Lucas)		304	ACV002 <sup>Ⓢ</sup>	29835	WL028	
	R	01/96→	Meritor (Lucas)		285	ACV002 <sup>Ⓢ</sup>	29835	WL028	
<b>Note: <sup>Ⓢ</sup> Replaced by ACV032, see Technical Bulletin #001</b>									
<b>PSV (Includes Evobus)</b> Vario, Vario Plus 512D	F	01/96→	Meritor (Lucas)		304	ACV002 <sup>Ⓢ</sup>	29835	WL028	
	R	01/96→	Meritor (Lucas)		285	ACV002 <sup>Ⓢ</sup>	29835	WL028	
<b>Note: <sup>Ⓢ</sup> Replaced by ACV032, see Technical Bulletin #001</b>									
<b>PSV (Includes Evobus)</b> Vario, Vario Plus 612D	F	01/96→	Meritor (Lucas)		304	ACV002 <sup>Ⓢ</sup>	29835	WL028	
	R	01/96→	Meritor (Lucas)		304	ACV002 <sup>Ⓢ</sup>	29835	WL028	
<b>Note: <sup>Ⓢ</sup> Replaced by ACV032, see Technical Bulletin #001</b>									
<b>PSV (Includes Evobus)</b> Vario, Vario Plus 614D	F	01/96→	Meritor (Lucas)		324	ACV002 <sup>Ⓢ</sup>	29835	WL028	
	R	01/96→	Meritor (Lucas)		324	ACV002 <sup>Ⓢ</sup>	29835	WL028	
<b>Note: <sup>Ⓢ</sup> Replaced by ACV032, see Technical Bulletin #001</b>									
<b>PSV (Includes Evobus)</b> Vario, Vario Plus 810TD 812D	F	01/96→	Meritor (Lucas)		324	ACV002 <sup>Ⓢ</sup>	29835	WL028	
	F	01/96→	Meritor (Lucas)		304	ACV002 <sup>Ⓢ</sup>	29835	WL028	
									-cont.

Where more than one part number is shown, use illustrations to determine correct pad fitment for the application



# Application Data

## Brake Pads, Wear Leads and Fitting Kits

# ANL Braking

						ACV/ADB	WVA NO.	WL	K
<b>MERCEDES – cont.</b> PSV (Includes Evobus) – cont.	R	01/96→	Meritor (Lucas)		304	ACV002 <sup>①</sup>	29835	WL028	
<b>Note:</b> ① Replaced by ACV032, see Technical Bulletin #001									
<b>PSV (Includes Evobus)</b> Vario, Vario Plus 814D	F	01/96→	Meritor (Lucas)		324	ACV002 <sup>①</sup>	29835	WL028	
	R	01/96→	Meritor (Lucas)		324	ACV002 <sup>①</sup>	29835	WL028	
<b>Note:</b> ① Replaced by ACV032, see Technical Bulletin #001									
<b>PSV (Includes Evobus)</b> Vario, Vario Plus 814TD	F	01/96→	Meritor (Lucas)		324	ACV002 <sup>①</sup>	29835	WL028	
	F	01/96→	Meritor (Lucas)		324	ACV002 <sup>①</sup>	29835	WL028	
<b>Note:</b> ① Replaced by ACV032, see Technical Bulletin #001									
<b>Sprinter</b> 200 Series	F	01/96→	Ate		276	ADB0212	21576	WL030	
	F	01/96→	Ate		276	ADB0212	21576	WL030	
	R	01/96→	Ate		258	ADB0453	21621	WL030	
	R	01/96→	Ate		272	ADB0453	21621	WL030	
	R	01/96→	Bosch		258	ADB0914	23021	WL030	
	R	01/96→	Bosch		272	ADB0914	23021	WL030	
<b>Sprinter</b> 300 Series	F	01/96→	Ate		276	ADB0212	21576	WL030	
	F	01/96→	Ate		276	ADB0212	21576	WL030	
	R	01/96→	Ate		258	ADB0478	21592	WL030	
	R	01/96→	Ate		272	ADB0478	21592	WL030	
	R	01/96→	Bosch		258	ADB0914	23021	WL030	
	R	01/96→	Bosch		272	ADB0914	23021	WL030	
<b>Sprinter</b> 400 Series	F	01/00→	Bosch		276	ADB0271	29076	WL030	
	F	01/96→	Wabco / Perrot		276	ADB0271	29076	WL030	
	F	01/96→	Wabco / Perrot		276	ADB0271	29076	WL030	
	R	01/96→	Bosch		272	ADB0271	29076	WL030	
	R	01/00→	Bosch		285	ADB0271	29076	WL030	
	R	01/96→	Wabco / Perrot		258	ADB0271	29076	WL030	
	R	01/96→	Wabco / Perrot		272	ADB0271	29076	WL030	
	R	01/96→	Wabco / Perrot		285	ADB0271	29076	WL030	
<b>T1 Series</b> 207D, 208, 209D, 210	F	01/77–01/95	Wabco / Perrot		280		20784		
	F	01/77–01/95	Wabco / Perrot		280	ADB0238	20784	WL029	
<b>T1 Series</b> 307D, 308, 308D, 310	F	01/77–01/95	Wabco / Perrot		280		20784		
	F	01/77–01/95	Wabco / Perrot		280	ADB0238	20784	WL029	
<b>T1 Series</b> 407D, 408D, 410, 410D	F	01/82–01/95	Wabco / Perrot		280		20784		
	F	10/82–01/95	Wabco / Perrot		280	ADB0238	20784	WL029	
	F	10/88–01/95	Wabco / Perrot		280		20784		
	F	10/88–01/95	Wabco / Perrot		280		20784		
	R	01/82–01/95							
	R	01/82–01/95							

Where more than one part number is shown, use illustrations to determine correct pad fitment for the application



# Application Data

## Brake Pads, Wear Leads and Fitting Kits

# ANL Braking

 	 			mm					
<b>MERCEDES – cont.</b>									
<b>T1 Series</b> 507D, 508D, 510, 510D									
	F	01/82–01/95	Wabco / Perrot		280				
	F	01/82–01/95	Wabco / Perrot		280	<b>ADB0238</b>	20784	<b>WL029</b>	
	F	10/88–01/95	Wabco / Perrot		280		20784		
	F	10/88–01/95	Wabco / Perrot		280		20784		
<b>T2 Series</b> 508D, 510, 511D <b>Note:</b> ① Replaced by ACV032, see Technical Bulletin #001									
	F	01/86→	Lucas		304	<b>ACV002</b> ①	29835	<b>WL028</b>	
<b>T2 Series</b> 608D, 609D <b>Note:</b> ① Replaced by ACV032, see Technical Bulletin #001									
	F	01/86→	Lucas		304	<b>ACV002</b> ①	29835	<b>WL028</b>	
<b>T2 Series</b> 709D, 711D 16" wheels <b>Note:</b> ① Replaced by ACV032, see Technical Bulletin #001									
	F	01/86–06/98	Lucas		304	<b>ACV002</b> ①	29835	<b>WL028</b>	
	F	01/86–06/98	Lucas		324	<b>ACV002</b> ①	29835	<b>WL028</b>	
<b>T2 Series</b> 809D, 811D, 814D 16" wheels 17.5" wheels <b>Note:</b> ① Replaced by ACV032, see Technical Bulletin #001									
	F	01/86–06/98	Lucas		324	<b>ACV002</b> ①	29835	<b>WL028</b>	
	F	01/86–06/98	Lucas		324	<b>ACV002</b> ①	29835	<b>WL028</b>	
<b>Unimog Series</b> MB Trac 65, 70									
	F	01/73–05/92	Ate		421	<b>ADB0125</b>	20392		
	R	01/73–05/92	Ate		421	<b>ADB0125</b>	20392		
<b>Unimog Series</b> MB Trac 700 → 1000									
	F	01/76–05/92	Ate		421	<b>ADB0125</b>	20392		
	R	01/76–05/92	Ate		421	<b>ADB0125</b>	20392		
<b>Unimog Series</b> U54 → U90									
	F	07/73–05/92	Ate			<b>ADB0125</b>	20392		
	R	07/73–05/92	Ate			<b>ADB0125</b>	20392		
<b>Unimog Series</b> U90 → U800									
	F	07/73–05/92	Ate		374	<b>ADB0125</b>	20392		
	F	07/73–05/92	Ate		386	<b>ADB0125</b>	20392		
	F	05/92→	Ate		374	<b>OTR162</b>	29324		
	F	05/92→	Ate		386	<b>OTR162</b>	29324		
	R	07/73–05/92	Ate		374	<b>ADB0125</b>	20392		
	R	07/73–05/92	Ate		386	<b>ADB0125</b>	20392		
	R	05/92→	Ate		374				
	R	05/92→	Ate		386				
<b>Unimog Series</b> U900, U1000									
	F	01/78–05/92	Ate			<b>ADB0125</b>	20392		
	R	01/78–05/92	Ate			<b>ADB0125</b>	20392		
<b>Unimog Series</b> U900, U1000									
	F	05/92→	Ate		374	<b>ADB0147</b>	20341		
	F	05/92→	Ate		386	<b>ADB0147</b>	20341		
	R	05/92→	Ate		374	<b>ADB0147</b>	20341		
	R	05/92→	Ate		386	<b>ADB0147</b>	20341		

Where more than one part number is shown, use illustrations to determine correct pad fitment for the application



# Application Data

## Brake Pads, Wear Leads and Fitting Kits

# ANL Braking

						ACV/ADB 	WVA NO.	WL 	K 
<b>MERCEDES – cont.</b>									
<b>Unimog Series</b> U1100	F	01/78–05/92	Ate			<b>ADB0147</b>	20341		
	R	01/78–05/92	Ate			<b>ADB0147</b>	20341		
<b>Unimog Series</b> U1100	F	05/92→	Ate		374	<b>OTR162</b>	29324		
	F	05/92→	Ate		386	<b>OTR162</b>	29324		
	R	05/92→	Ate		374				
	R	05/92→	Ate		386				
<b>Unimog Series</b> U1150	F	05/92→	Ate		374	<b>ADB0147</b>	20341		
	F	05/92→	Ate		386	<b>ADB0147</b>	20341		
	R	05/92→	Ate		374	<b>ADB0147</b>	20341		
	R	05/92→	Ate		386	<b>ADB0147</b>	20341		
<b>Unimog Series</b> U1200	F	01/78–05/92	Ate			<b>OTR162</b>	29324		
	R	01/78–05/92	Ate						
<b>Unimog Series</b> U1200	F	05/92→	Ate		374	<b>ADB0147</b>	20341		
	F	05/92→	Ate		386	<b>ADB0147</b>	20341		
	R	05/92→	Ate		374	<b>ADB0147</b>	20341		
	R	05/92→	Ate		386	<b>ADB0147</b>	20341		
<b>Unimog Series</b> U1250	F	05/92→	Ate		374	<b>OTR162</b>	29324		
	F	05/92→	Ate		386	<b>OTR162</b>	29324		
	R	05/92→	Ate		374				
	R	05/92→	Ate		386				
<b>Unimog Series</b> U1250L	F	05/92→	Ate		374	<b>ADB0147</b>	20341		
	F	05/92→	Ate		386	<b>ADB0147</b>	20341		
	R	05/92→	Ate		374	<b>ADB0147</b>	20341		
	R	05/92→	Ate		386	<b>ADB0147</b>	20341		
<b>Unimog Series</b> U1300	F	01/78–05/92	Ate			<b>OTR162</b>	29324		
	R	01/78–05/92	Ate						
<b>Unimog Series</b> U1300L, LL	F	01/78–05/92	Ate			<b>ADB0125</b>	20392		
	R	01/78–05/92	Ate			<b>ADB0125</b>	20392		
<b>Unimog Series</b> U1350L → U1450	F	05/92→	Ate		374	<b>ADB0147</b>	20341		
	F	05/92→	Ate		386	<b>ADB0147</b>	20341		
	R	05/92→	Ate		374	<b>ADB0147</b>	20341		
	R	05/92→	Ate		386	<b>ADB0147</b>	20341		

Where more than one part number is shown, use illustrations to determine correct pad fitment for the application



# Application Data

## Brake Pads, Wear Leads and Fitting Kits

# ANL Braking

					ACV/ADB	WVA NO.	WL	K
					mm			
<b>MERCEDES – cont.</b> Unimog Series U1500	F	01/78–05/92	Ate			<b>OTR162</b>	29324	
	R	01/78–05/92	Ate					
Unimog Series U1550	F	05/92→	Ate		374	<b>ADB0147</b>	20341	
	F	05/92→	Ate		386	<b>ADB0147</b>	20341	
	R	05/92→	Ate		374	<b>ADB0147</b>	20341	
	R	05/92→	Ate		386	<b>ADB0147</b>	20341	
Unimog Series U1600, U1650	F	05/92→	Ate		374	<b>OTR162</b>	29324	
	F	05/92→	Ate		386	<b>OTR162</b>	29324	
	R	05/92→	Ate		374	<b>ADB0147</b>	20341	
	R	05/92→	Ate		386	<b>ADB0147</b>	20341	
Unimog Series U1650L → U2450	F	05/92→	Ate		374	<b>OTR162</b>	29324	
	F	05/92→	Ate		386	<b>OTR162</b>	29324	
	R	05/92→	Ate		374			
	R	05/92→	Ate		386			
<b>Vito</b> 108 D, 110 D, 112 D, 113, 114	F	01/96→	Ate		276	<b>ADB0212</b>	21576	<b>WL030</b>
	F	01/96→	Bosch		276	<b>ADB0480</b>	23022	<b>WL030</b>
	R	01/96→	Ate		280		21904	
	R	01/96→	Ate		280	<b>ADB1455</b>	21904	
	R	01/98→	Bosch		280	<b>ADB0888</b>	23020	

**ACV002**

**ACV014**

**ACV030**

**ACV036**

**ACV037**

Replaced by **ACV032**

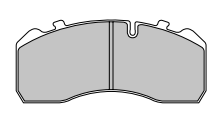
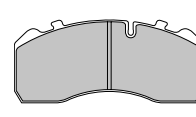
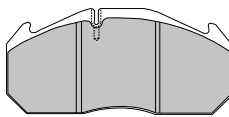
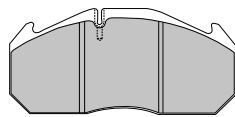
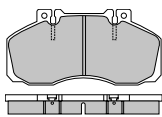

173.0 × 83.0 × 21.5

250.0 × 118.0 × 28

250.0 × 118.0 × 28

210.7 × 92.5 × 30

210.7 × 92.5 × 30

**ACV038**

**ACV041**

**ACV063**

**ADB0125**

**ADB0147**

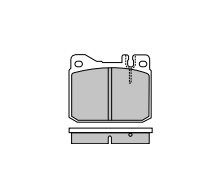
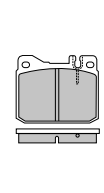
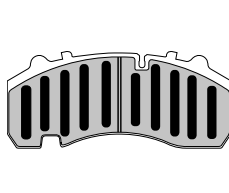
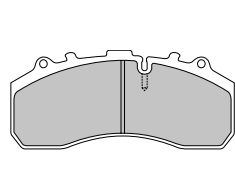
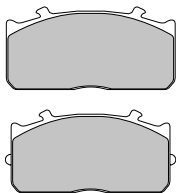

173.6 × 84 × 34.00/27.00

248.0 × 108.0 × 30

247 × 110 × 29

89.7 × 73.8 × 15

89.7 × 73.8 × 17.5

Where more than one part number is shown, use illustrations to determine correct pad fitment for the application





# Application Data

## Brake Pads, Wear Leads and Fitting Kits

# ANL Braking

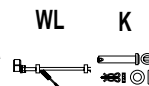
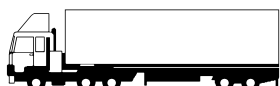

### MERCEDES – cont.

**ADB0183**

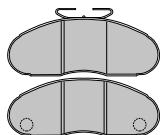

168.0 × 62.0 × 17

**ADB0212**

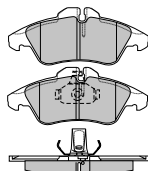

156.5 × 64.8 × 19.30

**ADB0238**

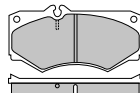

149.0 × 75.5 × 18

**ADB0271**

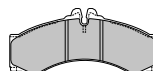

165.0 × 73.0 × 19.5

**ADB0453**

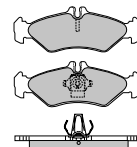

141.0 × 49.0 × 16.6

**ADB0478**

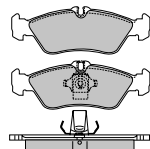

156.0 × 55.0 × 18

**ADB0480**



134.5 × 66 × 20

**ADB0888**



104 × 53 × 17

**ADB0914**

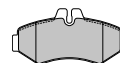

126 × 63 × 17.8

**ADB0991**

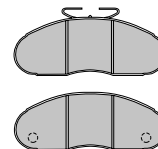

168.0 × 62.0 × 16.5

**ADB01089**

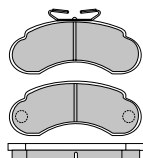

145.5 × 59.0 × 14

**ADB1183**

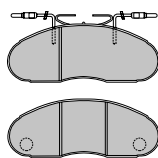

168.0 × 62.0 × 17

**ADB1455**

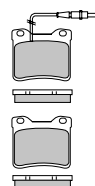

64.0 × 57.0 × 17

**ADB1991**

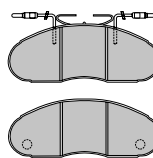

168.0 × 62.0 × 16.5

**OTR162**

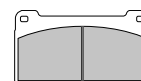

150 × 81 × 20.3

### MERCEDES AXLES

**with Haldex brakes**

DB 19

01/99→

Haldex



**ACV053**

29147

**K012**

**with Haldex brakes**

DB 20

01/99→

Haldex



430

**ACV054**

29143

**K012**

**with Knorr brakes**

SB 7000

01/98→

Knorr



430

**ACV042**

29108

**K005/  
K018**

**with Wabco / Perrot brakes**

PAN 19-1

01/99→

Wabco / Perrot



377

**ACV048**

29126

**K008**

**with Wabco / Perrot brakes**

PAN 22

01/98→

Wabco / Perrot



430

**ACV049**

29146

**K009**

Where more than one part number is shown, use illustrations to determine correct pad fitment for the application



# Application Data

## Brake Pads, Wear Leads and Fitting Kits

# ANL Braking

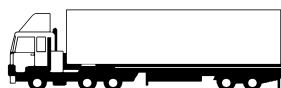

WL

K

### MERCEDES AXLES – cont.

ACV042

ACV048

ACV049

ACV053

ACV054

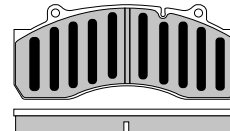
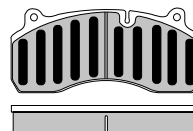
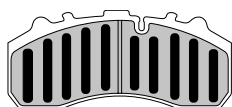

248.0 × 108.0 × 30

210 × 93 × 30

247 × 107 × 30

210.7 × 93.5 × 30

248 × 105 × 30

### MERITOR (Includes Lucas CV, Rockwell, R.O.R, Rubery Owen axles)

<b>B Duco</b> 17.5" wheels			Meritor (Lucas)			<b>ACV050</b>	29136		<b>K010</b>
<b>C Duco</b> 19.5" wheels			Meritor (Lucas)			<b>ACV051</b>	29137		<b>K011</b>
<b>D Duco</b> 22.5" wheels		01/99→	Meritor (Lucas)		434	<b>ACV055</b>	29125		<b>K013</b>
<b>DX175 Axle</b> 17.5" wheels			Meritor (Lucas)			<b>ACV056</b>	29149		<b>K014</b>
<b>DX195 Axle</b> 19.5" wheels		01/99→	Meritor (Lucas)		378	<b>ACV047</b>	29124		<b>K007</b>
<b>DX225 Axle</b> 22.5" wheels		06/00→	Meritor (Lucas)		434	<b>ACV057</b>	29150		<b>K007</b>
<b>D Elsa (D3)</b> 22.5" wheels			Meritor (Lucas)			<b>ACV014</b> <sup>①</sup>	29030		<b>K002/ K016 K013/ K016</b>
			Meritor (Lucas)			<b>ACV030</b> <sup>②</sup>	29053		
<b>Note: Disc Th 45→41mm use ①, 41→38mm use ②</b>									
<b>D Elsa 2</b> 22.5" wheels			Meritor (Lucas)			<b>ACV058</b>	29131		<b>K002</b>
<b>C Lisa</b> 19.5" wheels			Meritor (Lucas)			<b>ACV033</b>	29099		<b>K004</b>
<b>D Lisa</b> 22.5" wheels			Meritor (Lucas)			<b>ACV029</b>	29090		<b>K003/ K017</b>

Where more than one part number is shown, use illustrations to determine correct pad fitment for the application



# Application Data

## Brake Pads, Wear Leads and Fitting Kits

# ANL Braking



mm

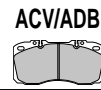

ACV/ADB



WVA NO.

WL

K



### MERITOR – cont.

ACV014

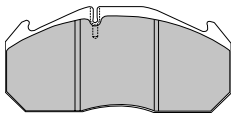

250.0 × 118.0 × 28

ACV029

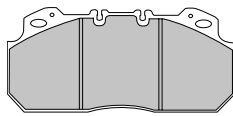

250.0 × 114.0 × 28

ACV030

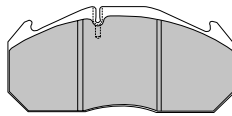

250.0 × 118.0 × 28

ACV033

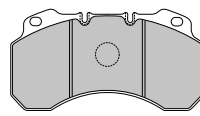

214 × 112 × 25

ACV047



205.5 × 100 × 27

ACV050

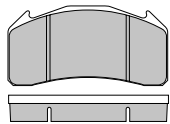

176 × 88 × 30

ACV051

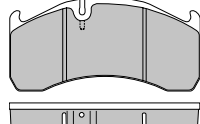

210 × 102 × 30

ACV055

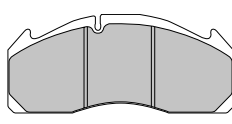

248 × 109 × 30

ACV056

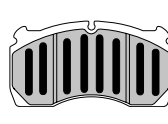

179.5 × 95 × 28

ACV057

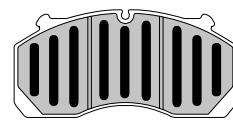

245 × 120 × 30

ACV058

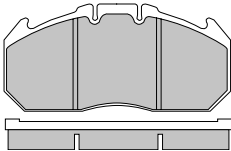

250.0 × 118.0 × 30

### MITSUBISHI

#### Canter

2.3, 2.5 (FB433, FB436)

F

01/86–08/92

Sumitomo

ADB01086

#### Canter

35 (3.5 T FE Series)  
2.8 Diesel  
Single Front Calipers

F

01/99→

Sumitomo



243

ADB01087

#### Canter

63 (6.3 T FE Series)  
3.9 Diesel  
Dual Front Caliper

F

01/99→

Sumitomo



252

ADB01088

R

01/99→



252

ADB01088

#### Canter

75 (7.5 T FE Series)  
3.9 Diesel  
Dual Front Caliper

F

01/99→

Sumitomo



252

ADB01088

R

01/99→



252

ADB01088

Where more than one part number is shown, use illustrations to determine correct pad fitment for the application



# Application Data

## Brake Pads, Wear Leads and Fitting Kits

# ANL Braking

						ACV/ADB	WVA NO.	WL	K
						mm			
<b>MITSUBISHI – cont.</b> Fuso FE Series	F	01/87–01/89	Sumitomo						
	R	01/87–01/89							
Fuso FE Series Dual Caliper models	F	01/89–01/94	Sumitomo			<b>ADB3285</b>	20892		
	F	01/94→	Sumitomo						
	R	01/94→							
<b>L200</b> 1.6 2x4 (L021)	F	01/79–01/86	Sumitomo		255	<b>ADB0316</b>	21109		
<b>L200</b> 2.0 2x4 LWB (K12T)	F	01/87–06/95	Sumitomo		258	<b>ADB3295</b>	21373		
<b>L200</b> 2.0 4x4 SWB (K22T)	F	01/87–06/95	Sumitomo			<b>ADB3295</b>	21373		
<b>L200</b> 2.5 2x4 LWB (K14T)	F	01/87–06/95	Sumitomo		258	<b>ADB3295</b>	21373		
<b>L200</b> 2.5 4x4 SWB (K24T)	F	01/87–06/95	Sumitomo			<b>ADB3295</b>	21373		
<b>L200</b> 2.4i 4x4	F	06/95–01/96	Akebono		277	<b>ADB3234</b>	21769		
	F	01/96–06/00	Akebono		276	<b>ADB3269</b>	23290		
	F	06/00–07/01	Sumitomo		276				
	F	07/01→	Sumitomo						
<b>L200</b> 2.5 4x4 Turbo Diesel (K34T)	F	06/95–01/96	Akebono		277	<b>ADB3234</b>	21769		
	F	01/96–06/00	Akebono		276	<b>ADB3269</b>	23290		
	F	06/00–07/01	Sumitomo		276				
	F	07/01→	Sumitomo						
<b>L300</b> 1.6 (L032)	F	01/80–01/81	Sumitomo						
	F	01/81–01/86	Sumitomo		255	<b>ADB0316</b>	21109		
<b>L300</b> 1.6 (L062)	F	01/83–01/86	Sumitomo		255	<b>ADB0316</b>	21109		
<b>L300</b> 1.6 (P02, P12)	F	01/87–05/99	Sumitomo		258	<b>ADB3295</b>	21373		
<b>L300</b> 2.5 (P05, P15)	F	01/87–05/99	Sumitomo		258	<b>ADB3295</b>	21373		
<b>L300</b> 2.5 (L039)	F	01/87→	Sumitomo		255	<b>ADB3295</b>	21373		
<b>L400</b> 2.0 except 4x4	F	09/96→	Akebono			<b>ADB3269</b>	23290		
	F	09/96→	Akebono						
	F	09/96→	Akebono			<b>ADB3234</b>	21769		
	R	09/96→	Akebono		315	<b>ADB3233</b>	21842		

Where more than one part number is shown, use illustrations to determine correct pad fitment for the application



# Application Data

## Brake Pads, Wear Leads and Fitting Kits

# ANL Braking

					ACV/ADB	WVA NO.	WL	K															
<b>MITSUBISHI – cont.</b>																							
<b>L400</b> 2.4 except 4x4  4x4	F	09/96→	Akebono			<b>ADB3269</b>	23290																
	F	09/96→	Akebono			<b>ADB3234</b>	21769																
	F	09/96→	Akebono			<b>ADB3234</b>	21769																
	R	09/96→	Akebono		315	<b>ADB3233</b>	21842																
<b>L400</b> 2.5 Turbo Diesel except 4x4  4x4	F	09/96→	Akebono			<b>ADB3269</b>	23290																
	F	09/96→	Akebono			<b>ADB3234</b>	21769																
	F	09/96→	Akebono			<b>ADB3234</b>	21769																
	R	09/96→	Akebono		315	<b>ADB3233</b>	21842																
<b>Montero</b> 2.5, 2.8, Turbo Diesel	F	04/91→	Akebono		276	<b>ADB3234</b>	21769																
	R	04/91→	Akebono		315	<b>ADB3233</b>	21842																
<b>Montero</b> 3.0 V6, 3.5 V6	F	04/91→	Akebono		276	<b>ADB3234</b>	21769																
	R	04/91→	Akebono		315	<b>ADB3233</b>	21842																
<table border="0" style="width:100%; text-align:center;"> <tr> <td><b>ADB0316</b></td> <td><b>ADB01086</b></td> <td><b>ADB01087</b></td> <td><b>ADB01088</b></td> <td><b>ADB3233</b></td> </tr> <tr> <td></td> <td></td> <td></td> <td></td> <td></td> </tr> <tr> <td>128.0 × 56.2 × 15.5</td> <td>133.0 × 53.0 × 17</td> <td>133.0 × 53.0 × 17</td> <td>125.25 × 60 × 19</td> <td>107.0 × 44.0 × 15.5</td> </tr> </table>									<b>ADB0316</b>	<b>ADB01086</b>	<b>ADB01087</b>	<b>ADB01088</b>	<b>ADB3233</b>						128.0 × 56.2 × 15.5	133.0 × 53.0 × 17	133.0 × 53.0 × 17	125.25 × 60 × 19	107.0 × 44.0 × 15.5
<b>ADB0316</b>	<b>ADB01086</b>	<b>ADB01087</b>	<b>ADB01088</b>	<b>ADB3233</b>																			
128.0 × 56.2 × 15.5	133.0 × 53.0 × 17	133.0 × 53.0 × 17	125.25 × 60 × 19	107.0 × 44.0 × 15.5																			
<table border="0" style="width:100%; text-align:center;"> <tr> <td><b>ADB3234</b></td> <td><b>ADB3269</b></td> <td><b>ADB3285</b></td> <td><b>ADB3295</b></td> </tr> <tr> <td></td> <td></td> <td></td> <td></td> </tr> <tr> <td>147.0 × 58.0 × 15.7</td> <td>137.6 × 55 × 16.5</td> <td>116.7 × 54.5 × 15</td> <td>128.3 × 57.3 × 16.2</td> </tr> </table>									<b>ADB3234</b>	<b>ADB3269</b>	<b>ADB3285</b>	<b>ADB3295</b>					147.0 × 58.0 × 15.7	137.6 × 55 × 16.5	116.7 × 54.5 × 15	128.3 × 57.3 × 16.2			
<b>ADB3234</b>	<b>ADB3269</b>	<b>ADB3285</b>	<b>ADB3295</b>																				
147.0 × 58.0 × 15.7	137.6 × 55 × 16.5	116.7 × 54.5 × 15	128.3 × 57.3 × 16.2																				
<b>MOSELEY / BOVA (→88)</b>																							
<b>Futura</b>	F	01/84–01/88	Knorr		460	<b>ACV006</b>	29747	<b>K001</b>															

Where more than one part number is shown, use illustrations to determine correct pad fitment for the application



# Application Data

## Brake Pads, Wear Leads and Fitting Kits

# ANL

## Braking

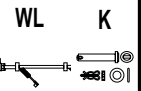

### MOSELEY / BOVA (→88) – cont.

ACV006

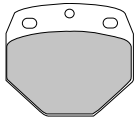

140.0 × 121.0 × 32

### MOSELEY / BOVA (88→)

see LEYLAND DAF

### NISSAN

**Avia**  
2.0 F 350

F 01/82→  
F 01/82→

Bendix  
Bendix

**ADB0183**  
**ADB1183**

29071  
29985

**Cabstar**  
2.0 (PGF22)

F 01/82–10/88  
F 01/82–10/88  
F 01/82–10/88  
F 01/82–10/88  
F 10/88–02/89  
F 02/89–08/92

Akebono  
Sumitomo  
Akebono  
Sumitomo  
Akebono  
Akebono

252  
 252  
 261  
 261  
 262  
 262

**ADB0276**<sup>①</sup>  
**ADB0276**<sup>①</sup>  
**ADB0758**

20863  
20863

Note: ① Use illustrations to determine correct pad fitment

**Cabstar**  
2.0 (F23)

F 08/92–12/00

Akebono

**ADB0758**

**Cabstar**  
2.3 (TGF22)

F 01/87–10/88  
F 01/87–10/88  
F 01/87–10/88  
F 01/87–10/88

Akebono  
Sumitomo  
Akebono  
Sumitomo

252  
 252  
 261  
 261

**ADB0276**  
**ADB0276**

20863  
20863

**Cabstar**  
2.3 (F22)

F 01/89–08/92

Akebono

262

**ADB0758**

**Cabstar**  
2.5 (EGF22)

F 01/86–01/87  
F 01/86–01/87  
F 01/86–01/87  
F 01/86–01/87

Akebono  
Sumitomo  
Akebono  
Sumitomo

252  
 252  
 261  
 261

**ADB0276**  
**ADB0276**

20863  
20863

**Cabstar**  
2.5 (F22)

F 01/89–08/92

Akebono

262

**ADB0758**

**Cabstar**  
2.5 (F23)

F 01/93–12/00

Akebono

**ADB0758**

**Cabstar**  
3.5 (F23)

F 01/95–12/00

Akebono

**ADB0758**

**Cherry Van**  
1.0 (F10 Series)

F 01/77–01/79

Tokico

219

**ADB0122**

20128

Where more than one part number is shown, use illustrations to determine correct pad fitment for the application



# Application Data

## Brake Pads, Wear Leads and Fitting Kits

# ANL

## Braking

						<b>WVA NO.</b>	<b>WL</b>	<b>K</b>	
<b>NISSAN – cont.</b> Ebro Pick-Up, Van F260, F275, F350	F	06/82–01/98	Bendix		263	<b>ADB0991</b>	29706		
	F	06/82–01/98	Bendix		263	<b>ADB1991</b>	29984		
	R	06/82–01/98	Wabco / Perrot						
Ebro Pick-Up, Van L35, L45	F	06/82–01/98	Bendix			<b>ADB0991</b>	29706		
	F	06/82–01/98	Bendix			<b>ADB1991</b>	29984		
	R	06/82–01/98	Bendix			<b>ADB0991</b>	29706		
Ebro Pick-Up, Van L60, L80  <b>Note: ① Replaced by ACV032, see Technical Bulletin #001</b>	F	01/92–01/98	Meritor (Lucas)			<b>ACV004</b> ①	29302		
	F	01/92–01/98	Meritor (Lucas)			<b>ACV007</b> ①	29033		
	R	01/92–01/98	Meritor (Lucas)			<b>ACV004</b> ①	29302		
Ebro Pick-Up, Van M90, M150  <b>Note: ① Replaced by ACV032, see Technical Bulletin #001</b>	F	06/82–01/98	Meritor (Lucas)			<b>ACV010</b> ①	29039		
	R	06/82–01/98	Meritor (Lucas)			<b>ACV010</b> ①	29039		
	F	06/82–01/98	Meritor (Lucas)			<b>ACV010</b> ①	29039		
Ebro Pick-Up, Van 2.8, 3.0 D, TD	F	03/89–06/93	Akebono		263	<b>ADB0276</b>	20863		
	F	03/89–06/93	Sumitomo		263				
Eco T T100.45, T100.56	F	01/98→	Meritor (Lucas)			<b>ACV033</b>	29099	<b>WL010</b>	<b>K004</b>
	R	01/98→							
Eco T T135.60, T135.70, T135.75	F	01/98→	Meritor (Lucas)			<b>ACV033</b>	29099	<b>WL010</b>	<b>K004</b>
	R	01/98→							
Eco T T160.75, T160.90	F	01/98→	Meritor (Lucas)			<b>ACV033</b>	29099	<b>WL010</b>	<b>K004</b>
	R	01/98→							
Interstar LH35 3.5T	F	10/01→	Bosch		280	<b>ADB01035</b>	23616		
	R	10/01→	Bosch		305	<b>ADB01036</b>	23669		
Interstar LM35 3.5T	F	10/01→	Bosch		280	<b>ADB01035</b>	23616		
	R	10/01→	Bosch		305	<b>ADB01036</b>	23669		
Interstar MH35 3.5T	F	10/01→	Bosch		280	<b>ADB01035</b>	23616		-cont.

Where more than one part number is shown, use illustrations to determine correct pad fitment for the application



# Application Data

## Brake Pads, Wear Leads and Fitting Kits

# ANL Braking

<b>NISSAN – cont.</b> Interstar – cont.	R	10/01→	Bosch		305	<b>ADB01036</b>	23669		
Interstar MM33 3.3T	F	10/01→	Bosch		280	<b>ADB01035</b>	23616		
	R	10/01→	Bosch		305	<b>ADB01036</b>	23669		
Interstar MM35 3.5T	F	10/01→	Bosch		280	<b>ADB01035</b>	23616		
	R	10/01→	Bosch		305	<b>ADB01036</b>	23669		
Interstar SL28 2.8T	F	10/01→	Bosch		280	<b>ADB01035</b>	23616		
	R	10/01→	Bosch		305	<b>ADB01036</b>	23669		
Interstar SL33 3.3T	F	10/01→	Bosch		280	<b>ADB01035</b>	23616		
	R	10/01→	Bosch		305	<b>ADB01036</b>	23669		
Interstar SM33 3.3T	F	10/01→	Bosch		280	<b>ADB01035</b>	23616		
	R	10/01→	Bosch		305	<b>ADB01036</b>	23669		
<b>King Cab</b> 2.0 (D21 Series - 2x4)	F	01/86→	Akebono		250	<b>ADB0177</b>	21099		
	F	01/86→	Akebono		250	<b>ADB3387</b>	21119		
<b>King Cab</b> 2.4 (D21 Series - 4x4)	F	01/86→	Akebono		267	<b>ADB0177</b>	21099		
	F	01/86→	Akebono		267	<b>ADB3387</b>	21119		
<b>King Cab</b> 2.5 (D21 Series - 2x4)	F	01/88→	Akebono		250	<b>ADB0177</b>	21099		
	F	01/88→	Akebono		250	<b>ADB3387</b>	21119		
<b>King Cab</b> 2.5 (D21 Series - 4x4)	F	01/88→	Akebono		267	<b>ADB0177</b>	21099		
	F	01/88→	Akebono		267	<b>ADB3387</b>	21119		
<b>Pick-Ups</b> 1.5 (620 Series - 2x4)	F	01/75–01/80	Sumitomo			<b>ADB0111</b> Ⓢ	20703		
	F	01/75–01/80	Sumitomo			<b>ADB0171</b> Ⓢ	20289		
<b>Note: Ⓢ Use illustrations to determine correct pad fitment</b>									
<b>Pick-Ups</b> 1.6 (720 Series - 2x4)	F	01/80–01/81	Sumitomo		271	<b>ADB0111</b> Ⓢ	20703		
	F	01/80–01/81	Sumitomo		271	<b>ADB0171</b> Ⓢ	20289		
<b>Note: Ⓢ Use illustrations to determine correct pad fitment</b>									

Where more than one part number is shown, use illustrations to determine correct pad fitment for the application





# Application Data

## Brake Pads, Wear Leads and Fitting Kits

# ANL

## Braking

						ACV/ADB	WVA NO.	WL	K
					mm				
<b>NISSAN – cont.</b> <b>Pick-Ups</b> 1.8 (720 Series - 2x4)	F	01/81–01/83	Sumitomo		271	ADB0111 <sup>⓪</sup>	20703		
	F	01/81–01/83	Sumitomo		271	ADB0171 <sup>⓪</sup>	20289		
	F	01/83–01/86	Sumitomo		250	ADB0111 <sup>⓪</sup>	20703		
	F	01/83–01/86	Sumitomo		250	ADB0171 <sup>⓪</sup>	20289		
<b>Note:</b> <sup>⓪</sup> Use illustrations to determine correct pad fitment									
<b>Pick-Ups</b> 2.0 (720 Series - 4x4)	F	01/80–01/83	Akebono		271	ADB0177	21099		
	F	01/80–01/83	Akebono		271	ADB3387	21119		
<b>Pick-Ups</b> 2.2 (720 Series - 4x4)	F	01/83–01/85	Akebono		267	ADB0177	21099		
	F	01/83–01/85	Akebono		267	ADB3387	21119		
<b>Pick-Ups</b> 2.0 (D21 Series - 2x4)	F	01/86→	Akebono		250	ADB0177	21099		
	F	01/86→	Akebono		250	ADB3387	21119		
<b>Pick-Ups</b> 2.4 (D21 Series - 4x4)	F	01/86→	Akebono		267	ADB0177	21099		
	F	01/86→	Akebono		267	ADB3387	21119		
<b>Pick-Ups</b> 2.5 (D21 Series - 2x4)	F	01/88→	Akebono		250	ADB0177	21099		
	F	01/88→	Akebono		250	ADB3387	21119		
<b>Pick-Ups</b> 2.5 (D21 Series - 4x4)	F	01/88→	Akebono		267	ADB0177	21099		
	F	01/88→	Akebono		267	ADB3387	21119		
<b>Primastar</b> 1.9 TDi	F	10/00→	Lucas			ADB01127	23099		
	R	10/00→	Lucas			ADB0874	23224		
<b>Primastar</b> 2.0i	F	10/00→	Lucas			ADB01127	23099		
	R	10/00→	Lucas			ADB0874	23224		
<b>Q Bic</b> 1.6	F	03/92–01/98	Sumitomo		240	ADB0207	20958		
	F	03/92–01/98	Sumitomo		240	ADB3207	21224		
<b>Q Bic</b> 1.7 Diesel	F	03/92–01/98	Sumitomo		240	ADB0207	20958		
	F	03/92–01/98	Sumitomo		240	ADB3207	21224		
<b>S Cargo</b> 2.3, 2.5, 2.7 Diesel, Turbo Diesel	F	06/90–01/98	Akebono		252	ADB0276	20863		
	F	06/90–01/98	Sumitomo		252				
<b>Sunny Van</b> 1.2 (B310 Series)	F	01/76–01/83	Sumitomo		245				
<b>Sunny Van</b> 1.3 (B11 Series)	F	01/83–07/92	Sumitomo		240	ADB0207	20958		
	F	01/83–07/92	Sumitomo		240	ADB3207	21224		
<b>Sunny Van</b> 1.7 D (Y10 Series)	F	01/92–10/96	Akebono		240	ADB3330	21718		

Where more than one part number is shown, use illustrations to determine correct pad fitment for the application



# Application Data

## Brake Pads, Wear Leads and Fitting Kits

# ANL Braking

						ACV/ADB	WVA	WL	K
						mm	NO.		
<b>NISSAN – cont.</b> Urvan 2.0, 2.3 (E23 Series)	F	01/81–01/87	Sumitomo		252				
	F	01/81–01/87	Sumitomo		252	<b>ADB0391</b>	20832 20628		
Urvan 2.0 (E24 Series)	F	01/87–10/96	Sumitomo		260	<b>ADB0423</b>	21347		
	F	01/87–10/96	Sumitomo		260	<b>ADB3863</b>	21348		
Urvan 2.3 (E24 Series)	F	01/87–01/89	Sumitomo		260	<b>ADB0423</b>	21347		
	F	01/87–01/89	Sumitomo		260	<b>ADB3863</b>	21348		
Urvan 2.5 (E24 Series)	F	01/89–10/96	Sumitomo		260	<b>ADB0423</b>	21347		
	F	01/89–10/96	Sumitomo		260	<b>ADB3863</b>	21348		
Vanette 1.5, 2.0 (C20 Series)	F	06/81–01/83	Akebono		250.3	<b>ADB0368</b>	20718		
	F	06/81–01/83	Akebono		250.3	<b>ADB3368</b>	20718		
	F	01/83–06/85	Akebono		250.3	<b>ADB0368</b>	20718		
	F	01/83–06/85	Akebono		250.3	<b>ADB3368</b>	20718		
Vanette 1.5, 2.0 (C120 Series)	F	01/86–01/87	Akebono		250	<b>ADB0177</b>	21099		
	F	01/86–01/87	Akebono		250	<b>ADB3387</b>	21119		
Vanette 1.5, 2.0 (C220 Series)	F	01/87–01/92	Akebono		250	<b>ADB0177</b>	21099		
	F	01/87–01/92	Akebono		250	<b>ADB3387</b>	21119		
	F	01/92–12/94	Akebono		250	<b>ADB0177</b>	21099		
	F	01/92–12/94	Akebono		250	<b>ADB3387</b>	21119		
Vanette Cargo (Serena van) 1.6	F	01/98→	Akebono		257	<b>ADB0177</b>	21099		
	F	01/98→	Akebono		257	<b>ADB3387</b>	21119		
	F	01/98→	Lucas		257	<b>ADB0447</b>	21481		
Vanette Cargo (Serena van) 2.0 Petrol	F	01/98→	Akebono		257	<b>ADB0177</b>	21099		
	F	01/98→	Akebono		257	<b>ADB3387</b>	21119		
	F	01/98→	Lucas		257	<b>ADB0447</b>	21481		
Vanette Cargo (Serena van) 2.0 Diesel, 2.3 Diesel	F	01/98→	Akebono		257	<b>ADB0177</b>	21099		
	F	01/98→	Akebono		257	<b>ADB3387</b>	21119		
	F	01/98→	Lucas		257	<b>ADB0447</b>	21481		

**ACV004**

Replaced by **ACV032**

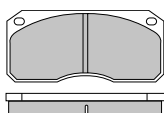

177 × 77.0 × 22

**ACV007**

Replaced by **ACV032**

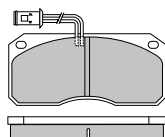

177 × 77 × 22

**ACV010**

Replaced by **ACV032**

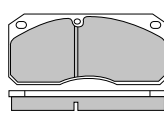

176 × 78 × 22

**ACV033**

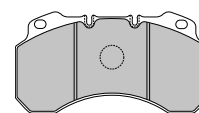

214 × 112 × 25

**ADB0111**



78.7 × 60.0 × 14.5

Where more than one part number is shown, use illustrations to determine correct pad fitment for the application



# Application Data

## Brake Pads, Wear Leads and Fitting Kits

# ANL

## Braking

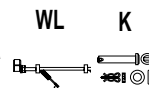

### NISSAN – cont.

ADB0122



58.0 × 55.0 × 14.5

ADB0171



77.8 × 68.7 × 15.3

ADB0177



129.9 × 49.0 × 17

ADB0183

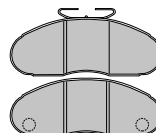

168.0 × 62.0 × 17

ADB0207



108.6 × 40.5 × 16

ADB0276

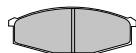

142.0 × 53.0 × 16.5

ADB0368



111.7 × 44.0 × 14.5

ADB0391



130.0 × 50.0 × 16.3

ADB0423



160.0 × 49.2 × 17

ADB0447



144.0 × 56.0 × 15.5

ADB0758

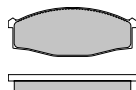

142.0 × 54.7 × 18

ADB0874



95.0 × 57.5 × 17

ADB0991

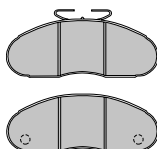

168.0 × 62.0 × 16.5

ADB01035

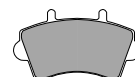

138 × 80 × 17.8

ADB01036



116 × 51 × 16.8

ADB01127



145 × 62 × 18

ADB1183

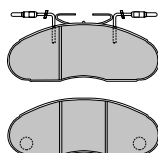

168.0 × 62.0 × 17

ADB1991

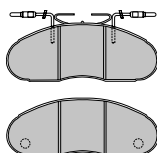

168.0 × 62.0 × 16.5

ADB3207

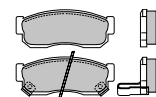

108.6 × 40.5 × 16

ADB3330

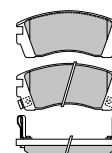

115.0 × 51.0 × 16

ADB3368

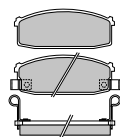

111.7 × 44.0 × 14.5

ADB3387

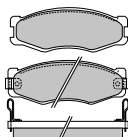

129.9 × 49.0 × 17

ADB3863

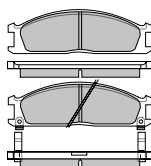

160.0 × 49.2 × 17

Where more than one part number is shown, use illustrations to determine correct pad fitment for the application











































# Application Data

## Brake Pads, Wear Leads and Fitting Kits

# ANL

## Braking

								ACV/ADB mm 	WVA NO. 	WL 	K 
<b>OPEL</b>											
<b>Astra Van (7/98→)</b> 1.2i non ABS ABS	F	07/98→	Ate		256	<b>ADB3584</b>	23063				
	F	07/98→	Ate		256	<b>ADB3583</b>	23116				
	R	07/98→	Bosch		240	<b>ADB3750</b>	23258				
<b>Astra Van (7/98→)</b> 1.4i 16V non ABS ABS	F	07/98→	Ate		256	<b>ADB3584</b>	23063				
	F	07/98→	Ate		256	<b>ADB3583</b>	23116				
	R	07/98→	Bosch		240	<b>ADB3750</b>	23258				
<b>Astra Van (7/98→)</b> 1.6i, 1.6i 16V non ABS ABS	F	07/98→	Ate		256	<b>ADB3584</b>	23063				
	F	07/98→	Ate		256	<b>ADB3583</b>	23116				
	R	07/98→	Bosch		240	<b>ADB3750</b>	23258				
<b>Astra Van (7/98→)</b> 1.7 Turbo Diesel non ABS ABS	F	07/98→	Ate		256	<b>ADB3584</b>	23063				
	F	07/98→	Ate		256	<b>ADB3583</b>	23116				
	R	07/98→	Bosch		240	<b>ADB3750</b>	23258				
<b>Astra Van (7/98→)</b> 2.0 Diesel non ABS ABS  non ABS ABS	F	07/98→	Ate		256	<b>ADB3584</b>	23063				
	F	07/98→	Ate		280	<b>ADB3583</b>	23116				
	R	07/98→	Bosch		240	<b>ADB3750</b>	23258				
	R	07/98→	Bosch		264	<b>ADB3750</b>	23258				
<b>Corsa Van / Combo (10/00→)</b> 1.2i 16V	F	10/00-06/02	Lucas		240	<b>ADB31112</b>	23225				
	F	06/02→	Lucas		240	<b>ADB31161</b>					
	F	10/00-06/02	Lucas		240	<b>ADB31112</b>	23225				
	F	06/02→	Lucas		240	<b>ADB31161</b>					
<b>Corsa Van / Combo (10/00→)</b> 1.7 TDi	F	10/00-06/02	Lucas		260	<b>ADB31112</b>	23225				
	F	06/02→	Lucas		260	<b>ADB31161</b>					
<b>Movano</b> 2.5 Diesel	F	03/98-10/00	Bendix		280	<b>ADB01021</b>	23302				
	F	10/00→	Bosch		280	<b>ADB01035</b>	23616				
	R	10/00→	Bosch		305	<b>ADB01036</b>	23669				
<b>Movano</b> 2.8 Turbo Diesel	F	03/98-10/00	Bendix		280	<b>ADB01021</b>	23302				
	F	10/00→	Bosch		280	<b>ADB01035</b>	23616				
	R	10/00→	Bosch		305	<b>ADB01036</b>	23669				
<b>Vivaro</b> 1.9Di, 1.9TDi	F	09/00→	Lucas			<b>ADB01127</b>	23099				-cont.

Where more than one part number is shown, use illustrations to determine correct pad fitment for the application



# Application Data

## Brake Pads, Wear Leads and Fitting Kits

# ANL Braking

						ACV/ADB	WVA NO.	WL	K
<b>OPEL – cont.</b> Vivaro – cont.	R	09/00→	Lucas			ADB0874	23224		
Vivaro 2.0i	F	09/00→	Lucas			ADB01127	23099		
	R	09/00→	Lucas			ADB0874	23224		
<b>ADB0874</b>	<b>ADB01021</b>	<b>ADB01035</b>	<b>ADB01036</b>	<b>ADB01127</b>					
95.0 × 57.5 × 17	139 × 68 × 18.7	138 × 80 × 17.8	116 × 51 × 16.8	145 × 62 × 18					
<b>ADB3583</b>	<b>ADB3584</b>	<b>ADB3750</b>	<b>ADB31112</b>	<b>ADB31161</b>					
156.5 × 79.5/72.0 × 19.6	177.8/160.2 × 62.5/63 × 17.7/16.7	105 × 43 × 16	131.8 × 51.4 × 17.0	131.8 × 51.4 × 17.0					
<b>OPTARE</b>									
City Pacer	F	01/86→	Ate		281		20280		
Metro Rider	F	01/88→	Meritor (Lucas)		322	ACV004 <sup>①</sup>	29302		
	F	01/88→	Meritor (Lucas)		322	ACV007 <sup>①</sup>	29033		
	R	01/88→	Meritor (Lucas)		322	ACV004 <sup>①</sup>	29302		
	R	01/88→	Meritor (Lucas)		322	ACV007 <sup>①</sup>	29033		
Note: <sup>①</sup> Replaced by ACV032, see Technical Bulletin #001									
Solo	F	01/96–06/02	Meritor (Lucas)		322	ACV004 <sup>①</sup>	29302		
	F	01/96–06/02	Meritor (Lucas)		322	ACV007 <sup>①</sup>	29033		
	R	01/96–06/02	Meritor (Lucas)		322	ACV004 <sup>①</sup>	29302		
	R	01/96–06/02	Meritor (Lucas)		322	ACV007 <sup>①</sup>	29033		
Note: <sup>①</sup> Replaced by ACV032, see Technical Bulletin #001									
Solo	F	06/02→	Wabco / Perrot		330	ACV039	29088	WL013	
	R	06/02→	Wabco / Perrot		330	ACV039	29088	WL013	
Star Rider	F	01/86→	Meritor (Lucas)		324	ACV002 <sup>①</sup>	29835	WL028	–cont.

Where more than one part number is shown, use illustrations to determine correct pad fitment for the application



# Application Data

## Brake Pads, Wear Leads and Fitting Kits

# ANL

## Braking



WL

K

### OPTARE – cont.

Star Rider – cont.

R 01/86→

Note: ① Replaced by ACV032, see Technical Bulletin #001

**ACV002**

**ACV004**

**ACV007**

**ACV039**

Replaced by **ACV032**

Replaced by **ACV032**

Replaced by **ACV032**

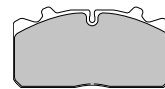
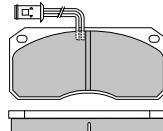
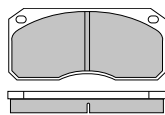
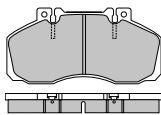

173.0 × 83.0 × 21.5

177 × 77.0 × 22

177 × 77 × 22

175.6 × 85.6 × 26

### PERLINI

121-27, 131-30, 131-33

F 01/85→

Wabco / Perrot

29626

R 01/85→

Wabco / Perrot

29626

DP366C, DP655C

F

29025

R

29025

### PERROT

see WABCO

### PEUGEOT

106 Van  
1.5 Diesel

F 01/94→  
F 01/94→  
F 01/94→  
F 01/94→  
F 01/94→  
F 01/94→  
F 10/91→

Bendix  
Bendix  
Ate  
Ate  
Bendix  
Bendix  
Lucas

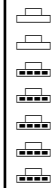

247  
247  
247  
247  
247  
247  
247

**ADB0258**  
**ADB2416**  
**ADB0570**  
**ADB1570**  
**ADB0258**  
**ADB2416**  
**ADB1926**

20905  
21061  
21827  
21430  
20905  
21061  
21614

205 Van  
all models

F 03/83–01/95  
F 03/83–01/95  
F 03/83–01/95  
F 03/83–01/95

Bendix  
Bendix  
Lucas  
Lucas



247  
247  
247  
247

**ADB0258**  
**ADB2258**  
**ADB0515**  
**ADB1515**

20905  
20905  
20988  
20988

305 Van  
all models

F 07/82–01/88  
F 07/82–01/88

Bendix  
Bendix



266  
266

**ADB0258**  
**ADB2258**

20905  
20905

306 Van (→5/97)  
1.9 Diesel, 1.9 Turbo Diesel

F 01/93–05/97  
F 01/93–05/97

Ate  
Ate



247  
247

**ADB0570**  
**ADB1570**

21827  
21430

Where more than one part number is shown, use illustrations to determine correct pad fitment for the application



# Application Data

## Brake Pads, Wear Leads and Fitting Kits

# ANL

## Braking

						ACV/ADB	WVA NO.	WL	K
<b>PEUGEOT – cont.</b> 306 Van (5/97→) 1.9 Diesel, 1.9 Turbo Diesel	F	05/97–04/00	Ate		247	<b>ADB0570</b>	21827		
	F	05/97–04/00	Ate		247	<b>ADB1570</b>	21430		
	F	05/97–04/00	Lucas		266	<b>ADB0892</b>	23346		
	F	05/97–04/00	Lucas		266	<b>ADB1174</b>	23124		
<b>306 Van (5/97→)</b> 2.0 HDi	F	04/00→	Ate		247	<b>ADB0570</b>	21827		
	F	04/00→	Ate		247	<b>ADB1570</b>	21430		
	F	04/00→	Lucas		266	<b>ADB0892</b>	23346		
	F	04/00→	Lucas		266	<b>ADB1174</b>	23124		
<b>504 Pick-up, Van</b> all models	F	01/71–01/92	Ate		273	<b>ADB1308</b>	20455		
	F	01/71–01/92	Lucas		273	<b>ADB1205</b>	20145		
	F	01/71–01/92	Ate		273	<b>ADB1308</b>	20455		
	F	01/71–01/92	Lucas		273	<b>ADB1205</b>	20145		
<b>Boxer →01/02</b> 1.0 Tonne 1.9 D, 1.9 TD, 2.0i, 2.5 D, 2.5 TD	F	02/94–01/02	Lucas		280	<b>ADB2219</b>	21627		
	F	02/94–01/02	Lucas		280	<b>ADB2219</b>	21627		
<b>Boxer →01/02</b> 1.4 Tonne 1.9 D, 1.9 TD, 2.0i, 2.5 D, 2.5 TD	F	02/94–01/02	Lucas		280	<b>ADB2219</b>	21627		
	F	02/94–01/02	Lucas		280	<b>ADB2219</b>	21627		
<b>Boxer →01/02</b> 1.8 Tonne 2.0i non ABS ABS 2.5 D, 2.5 TD non ABS ABS	F	02/94–01/02	Lucas		300	<b>ADB1275</b>	21629		
	F	02/94–01/02	Lucas		300	<b>ADB1275</b>	21629		
	F	02/94–01/02	Lucas		300	<b>ADB1275</b>	21629		
	F	02/94–01/02	Lucas		300	<b>ADB1275</b>	21629		
<b>Boxer 01/02→</b> 11	F	01/02→	Brembo		280	<b>ADB11040</b>	23602		
	R	01/02→	Brembo		280	<b>ADB01042</b>			
<b>Boxer 01/02→</b> 15	F	01/02→	Brembo		280	<b>ADB11040</b>	23602		
	R	01/02→	Brembo		280	<b>ADB01042</b>			
<b>Boxer 01/02→</b> 18	F	01/02→	Brembo		300	<b>ADB11041</b>	23603		
	R	01/02→	Brembo		280	<b>ADB01042</b>			
<b>Expert</b> 1.4i	F	01/96→	Bendix		257	<b>ADB2714</b>	23003		
	F	01/96→	Lucas		257	<b>ADB11001</b>	21801		
<b>Expert</b> 1.6i	F	01/96→	Bendix		257	<b>ADB2714</b>	23003		
	F	01/96→	Lucas		257	<b>ADB11001</b>	21801		

Where more than one part number is shown, use illustrations to determine correct pad fitment for the application



# Application Data

## Brake Pads, Wear Leads and Fitting Kits

# ANL Braking

					ACV/ADB	WVA NO.	WL	K															
					mm																		
<b>PEUGEOT – cont.</b>																							
<b>Expert</b> 1.9 D, 1.9 TD	F	01/96→	Bendix		257	<b>ADB2714</b>	23003																
	F	01/96→	Bendix		281	<b>ADB2714</b>	23003																
	F	01/96→	Lucas		257	<b>ADB11001</b>	21801																
	F	01/96→	Lucas		281	<b>ADB11001</b>	21801																
<b>Expert</b> 2.0 HDI	F	01/96→	Bendix		257	<b>ADB2714</b>	23003																
	F	01/96→	Bendix		281	<b>ADB2714</b>	23003																
	F	01/96→	Lucas		257	<b>ADB11001</b>	21801																
	F	01/96→	Lucas		281	<b>ADB11001</b>	21801																
<b>J5 Van</b> except 1.8 Ton, Turbo →VIN 0154461 VIN 0154462→	F	01/81–03/84	Lucas		256	<b>ADB1254</b>	20741																
	F	03/84–01/94	Lucas		256	<b>ADB1254</b>	20741																
<b>J5 Van</b> 1.8 Ton, Turbo	F	01/87–01/94	Lucas		290		21205																
<b>J7 Van</b> all models	F	09/73–01/80	Bendix		280																		
	R	09/73–01/80																					
<b>J9 Van</b> all models	F	09/73–01/85	Bendix		280																		
	F	01/85–01/88	Bendix		280																		
	R	09/73–01/88																					
<b>Partner</b> 1.4	F	01/97→	Lucas		266	<b>ADB0892</b>	23346																
	F	01/97→	Lucas		266	<b>ADB1174</b>	23124																
	F	01/97→	Lucas		266	<b>ADB0892</b>	23346																
	F	01/97→	Lucas		266	<b>ADB1174</b>	23124																
<b>Partner</b> 1.8 D, 1.9 D	F	01/97→	Lucas		266	<b>ADB0892</b>	23346																
	F	01/97→	Lucas		266	<b>ADB1174</b>	23124																
	F	01/97→	Lucas		266	<b>ADB0892</b>	23346																
	F	01/97→	Lucas		266	<b>ADB1174</b>	23124																
<table border="0" style="width:100%; text-align:center;"> <tr> <td><b>ADB0258</b></td> <td><b>ADB0515</b></td> <td><b>ADB0570</b></td> <td><b>ADB0892</b></td> <td><b>ADB01042</b></td> </tr> <tr> <td></td> <td></td> <td></td> <td></td> <td></td> </tr> <tr> <td>105.0 × 54.0 × 18</td> <td>89.9 × 58.8 × 17.5</td> <td>141.3 × 47.6 × 17</td> <td>130 × 56 × 17.5</td> <td>110 × 50 × 20</td> </tr> </table>									<b>ADB0258</b>	<b>ADB0515</b>	<b>ADB0570</b>	<b>ADB0892</b>	<b>ADB01042</b>						105.0 × 54.0 × 18	89.9 × 58.8 × 17.5	141.3 × 47.6 × 17	130 × 56 × 17.5	110 × 50 × 20
<b>ADB0258</b>	<b>ADB0515</b>	<b>ADB0570</b>	<b>ADB0892</b>	<b>ADB01042</b>																			
105.0 × 54.0 × 18	89.9 × 58.8 × 17.5	141.3 × 47.6 × 17	130 × 56 × 17.5	110 × 50 × 20																			
Where more than one part number is shown, use illustrations to determine correct pad fitment for the application																							





# Application Data

## Brake Pads, Wear Leads and Fitting Kits

# ANL Braking



WL

K

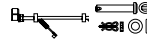

### PEUGEOT – cont.

ADB1174

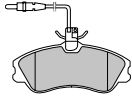

130 × 56 × 17.5

ADB1205

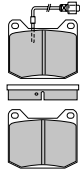

78.4 × 64.5 × 17.5

ADB1254

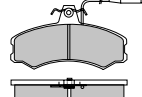

130.0 × 71.5 × 19

ADB1275

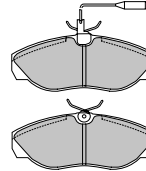

160.0 × 65.0 × 19

ADB1308

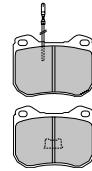

89.7 × 70.5 × 19

ADB1515

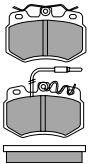

89.9 × 58.8 × 17.5

ADB1570

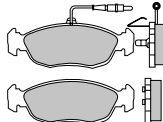

141.3 × 47.6 × 17

ADB1926

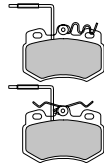

89.9 × 58.8 × 17.5

ADB2219

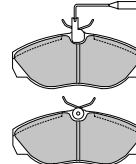

145.0 × 62.0 × 19

ADB2258

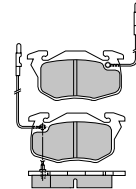

105.0 × 54.0 × 18

ADB2416

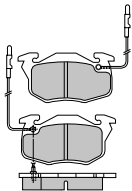

105.0 × 54.0 × 18

ADB2714

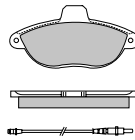

140 × 69 × 18.3

ADB11001

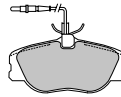

130.0 × 60.0 × 18

ADB11040

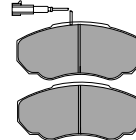

141 × 66 × 19

ADB11041

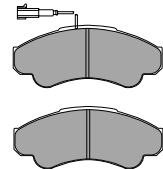

165 × 70 × 19

### PIAGGIO

Porter

F 01/93→

Akebono



210

ADB0770

20780

R 01/93→

ADB0770



78.0 × 62.0 × 13.5

Where more than one part number is shown, use illustrations to determine correct pad fitment for the application



# Application Data

## Brake Pads, Wear Leads and Fitting Kits

# ANL

## Braking

					ACV/ADB	WVA	WL	K
					mm	NO.		
<b>PROTON</b>								
Pick up	F	08/02→	Lucas		281	<b>ADB3813</b>	21983	
	R	08/02→	Lucas		260	<b>ADB3945</b>	21861	
<b>ADB3813</b>		<b>ADB3945</b>						
130 × 78 × 17		87.6 × 47.0 × 15						
<b>RENAULT</b>								
R4 Van 1.1 (R2370)	F	01/80–01/86	Bendix		227	<b>ADB4311</b>	20347	
	F	01/80–01/86	Lucas		227		20480	
Clio Van (→98) 1.2i	F	01/90–03/98	Bendix		238	<b>ADB0258</b>	20905	
	F	01/90–03/98	Bendix		238	<b>ADB2258</b>	20905	
	F	01/90–03/98	Lucas		238	<b>ADB0431</b>	21463	
	F	01/90–03/98	Lucas		238	<b>ADB1431</b>	21463	
Clio Van (→98) 1.9 Diesel	F	01/90–03/98	Bendix		238	<b>ADB0258</b>	20905	
	F	01/90–03/98	Bendix		238	<b>ADB2258</b>	20905	
	F	01/90–03/98	Lucas		238	<b>ADB0431</b>	21463	
	F	01/90–03/98	Lucas		238	<b>ADB1431</b>	21463	
	F	01/90–03/98	Bendix		238	<b>ADB0258</b>	20905	
	F	01/90–03/98	Bendix		238	<b>ADB2258</b>	20905	
	F	01/90–03/98	Lucas		238	<b>ADB0431</b>	21463	
	F	01/90–03/98	Lucas		238	<b>ADB1431</b>	21463	
Clio Van (98→) 1.2i	F	03/98→	Lucas		238	<b>ADB0431</b>	21463	
	F	03/98→	Lucas		238	<b>ADB1431</b>	21463	
	F	03/98→	Lucas		238	<b>ADB0431</b>	21463	
	F	03/98→	Lucas		238	<b>ADB1431</b>	21463	
Clio Van (98→) 1.9 Diesel	F	03/98→	Lucas		238	<b>ADB0431</b>	21463	
	F	03/98→	Lucas		238	<b>ADB1431</b>	21463	
	F	03/98→	Lucas		238	<b>ADB0431</b>	21463	
	F	03/98→	Lucas		238	<b>ADB1431</b>	21463	
	F	03/98→	Lucas		259	<b>ADB0431</b>	21463	
	F	03/98→	Lucas		259	<b>ADB1431</b>	21463	
Extra / Express 1.0 (F400)	F	01/85–11/98	Bendix		238	<b>ADB2533</b>	21096	
	F	01/85–11/98	Lucas		238	<b>ADB0431</b>	21463	
	F	01/85–11/98	Lucas		238	<b>ADB1133</b>	20937	

Where more than one part number is shown, use illustrations to determine correct pad fitment for the application



# Application Data

## Brake Pads, Wear Leads and Fitting Kits

# ANL

## Braking

						ACV/ADB	WVA NO.	WL	K
						mm			
<b>RENAULT – cont.</b> Extra / Express 1.1 (F401)	F	01/85–06/88	Bendix		238	<b>ADB2533</b>	21096		
	F	01/85–06/88	Lucas		238	<b>ADB0431</b>	21463		
	F	01/85–06/88	Lucas		238	<b>ADB1133</b>	20937		
	F	06/88–11/98	Bendix		238	<b>ADB2533</b>	21096		
	F	06/88–11/98	Lucas		238	<b>ADB0431</b>	21463		
	F	06/88–11/98	Lucas		238	<b>ADB1133</b>	20937		
<b>Extra / Express</b> 1.4 (F402)	F	01/85–11/98	Bendix		238	<b>ADB0258</b>	20905		
	F	01/85–11/98	Bendix		238	<b>ADB2258</b>	20905		
	F	01/85–11/98	Lucas		238	<b>ADB0431</b>	21463		
	F	01/85–11/98	Lucas		238	<b>ADB1133</b>	20937		
<b>Extra / Express</b> 1.6 (F404, F406) Petrol and Diesel	F	01/85–01/86	Bendix		238	<b>ADB0258</b>	20905		
	F	01/85–01/86	Bendix		238	<b>ADB2258</b>	20905		
	F	01/85–01/86	Lucas		238	<b>ADB0431</b>	21463		
	F	01/85–01/86	Lucas		238	<b>ADB1133</b>	20937		
	F	01/86–11/98	Bendix		238	<b>ADB0258</b>	20905		
	F	01/86–11/98	Bendix		238	<b>ADB2258</b>	20905		
	F	01/86–11/98	Lucas		238	<b>ADB0431</b>	21463		
	F	01/86–11/98	Lucas		238	<b>ADB1133</b>	20937		
<b>Extra / Express</b> 1.9	F	01/91–11/98	Bendix		238	<b>ADB0258</b>	20905		
	F	01/91–11/98	Bendix		238	<b>ADB2258</b>	20905		
	F	01/91–11/98	Lucas		238	<b>ADB0431</b>	21463		
	F	01/91–11/98	Lucas		238	<b>ADB1431</b>	21463		
<b>Kangoo Van</b> 1.2i	F	01/98→	Bosch		238	<b>ADB0485</b>	21978		
	F	01/98→	Bosch		238	<b>ADB2485</b>	21978		
<b>Kangoo Van</b> 1.4i	F	01/98→	Bosch		238	<b>ADB0485</b>	21978		
	F	01/98→	Bosch		238	<b>ADB2485</b>	21978		
<b>Kangoo Van</b> 1.5 Turbo Diesel	F	01/98→	Bosch		238	<b>ADB0485</b>	21978		
	F	01/98→	Bosch		238	<b>ADB2485</b>	21978		
<b>Kangoo Van</b> 1.9 Turbo Diesel	F	01/98→	Bosch		238	<b>ADB0485</b>	21978		
	F	01/98→	Bosch		238	<b>ADB2485</b>	21978		
<b>Mascot</b> 110, 130, 150	F	10/00→	Brembo		290				
	R	10/00→	Brembo			<b>ADB0931</b>	29121		
<b>Master →98</b> 2.0 P35, T30, T35	F	01/81–03/98	Lucas		278		20380		
	F	01/81–03/98	Lucas		278		21110		
<b>Master →98</b> 2.4 P35, T30, T35	F	01/81–01/89	Lucas		278		20380		
	F	01/81–01/89	Lucas		278		21110		

Where more than one part number is shown, use illustrations to determine correct pad fitment for the application



# Application Data

## Brake Pads, Wear Leads and Fitting Kits

# ANL Braking

<b>RENAULT – cont.</b>									
<b>Master →98</b> 2.5 P35, T30, T35	F	01/97–03/98	Bendix		278				
	F	01/89–03/98	Lucas		278		20380		
	F	01/89–03/98	Lucas		278		21110		
<b>Master 98→</b> T28, T33, T35	F	03/98–10/00	Bendix		280	<b>ADB01021</b>	23302		
	F	10/00→	Bosch		280	<b>ADB01035</b>	23616		
	R	10/00→	Bosch		305	<b>ADB01036</b>	23669		
<b>Master 98→</b> T28, T33, T35	F	03/98–10/00	Bendix		280	<b>ADB01021</b>	23302		
	F	10/00→	Bosch		280	<b>ADB01035</b>	23616		
	R	10/00→	Bosch		305	<b>ADB01036</b>	23669		
<b>Traffic →10/00</b> 1.4 T800	F	01/81–08/84	Bendix		252				
	F	08/84–02/90	Bendix		252	<b>ADB21048</b>	20926		
<b>Traffic →10/00</b> 1.4 T900	F	09/89–10/00	Bendix		252	<b>ADB21048</b>	20926		
<b>Traffic →10/00</b> 1.6 P1000	F	01/81–08/84	Bendix		252				
	F	08/84–09/89	Bendix		252	<b>ADB21048</b>	20926		
<b>Traffic →10/00</b> 1.7 Bus FWD	F	09/89–10/00	Bendix		252	<b>ADB21048</b>	20926		
<b>Traffic →10/00</b> 1.7 T1000	F	01/81–08/84	Bendix		252				
	F	08/84–02/90	Bendix		252	<b>ADB21048</b>	20926		
<b>Traffic →10/00</b> 1.7 T1100	F	09/89–10/00	Bendix		252	<b>ADB21048</b>	20926		
<b>Traffic →10/00</b> 2.0 4x4 Van	F	09/89–10/00	Bendix		267	<b>ADB0183</b>	29071		
	F	09/89–10/00	Bendix		267	<b>ADB1183</b>	29985		
<b>Traffic →10/00</b> 2.0 Bus FWD	F	09/89–10/00	Bendix		252	<b>ADB21048</b>	20926		
<b>Traffic →10/00</b> 2.0 P1000D Van	F	01/81–08/84	Bendix		252				
<b>Traffic →10/00</b> 2.0 P1200D Van	F	08/84–09/89	Bendix		252	<b>ADB21048</b>	20926		
<b>Traffic →10/00</b> 2.0 P1400 Chassis cab, pick-up	F	09/89–10/00	Bendix		252	<b>ADB21048</b>	20926		
<b>Traffic →10/00</b> 2.0 T1400 Van	F	08/84–02/90	Bendix		252	<b>ADB21048</b>	20926		
<b>Traffic →10/00</b> 2.1 Bus FWD	F	09/89–10/00	Bendix		252	<b>ADB21048</b>	20926		
<b>Traffic →10/00</b> 2.1 P1400 Chassis cab, pick-up	F	09/89–10/00	Bendix		252	<b>ADB21048</b>	20926		

Where more than one part number is shown, use illustrations to determine correct pad fitment for the application



# Application Data

## Brake Pads, Wear Leads and Fitting Kits

### ANL Braking

						ACV/ADB	WVA NO.	WL	K
						mm			
<b>RENAULT – cont.</b>									
<b>Traffic →10/00</b> 2.1 T1000 Van	F	01/81–08/84	Bendix		252				
<b>Traffic →10/00</b> 2.1 T1100D Van	F	09/89–10/00	Bendix		252	<b>ADB21048</b>	20926		
<b>Traffic →10/00</b> 2.1 T1300D Van, T1600D Van	F	08/84–02/90	Bendix		252	<b>ADB21048</b>	20926		
<b>Traffic →10/00</b> 2.2 D Bus, Van Phase II	F	09/89–10/00	Bendix		267	<b>ADB0183</b>	29071		
	F	09/89–10/00	Bendix		267	<b>ADB1183</b>	29985		
<b>Traffic →10/00</b> 2.2 D 4x4 Van	F	09/89–10/00	Bendix		267	<b>ADB0183</b>	29071		
	F	09/89–10/00	Bendix		267	<b>ADB1183</b>	29985		
<b>Traffic →10/00</b> 2.2 T1400D Van	F	09/89–10/00	Bendix		267	<b>ADB0183</b>	29071		
	F	09/89–10/00	Bendix		267	<b>ADB1183</b>	29985		
<b>Traffic →10/00</b> 2.5 D Bus, Van Phase II	F	09/89–10/00	Bendix		267	<b>ADB0183</b>	29071		
	F	09/89–10/00	Bendix		267	<b>ADB1183</b>	29985		
<b>Traffic →10/00</b> 2.5 D 4x4 Van	F	09/89–10/00	Bendix		267	<b>ADB0183</b>	29071		
	F	09/89–10/00	Bendix		267	<b>ADB1183</b>	29985		
<b>Traffic →10/00</b> 2.5 T1400D Van	F	09/89–10/00	Bendix		267	<b>ADB0183</b>	29071		
	F	09/89–10/00	Bendix		267	<b>ADB1183</b>	29985		
<b>Traffic 10/00→</b> 1.9 TDi	F	10/00→	Lucas			<b>ADB01127</b>	23099		
	R	10/00→	Lucas			<b>ADB0874</b>	23224		
<b>Traffic 10/00→</b> 2.0i	F	10/00→	Lucas			<b>ADB01127</b>	23099		
	R	10/00→	Lucas			<b>ADB0874</b>	23224		

**ADB0183**

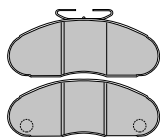

168.0 × 62.0 × 17

**ADB0258**

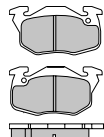

105.0 × 54.0 × 18

**ADB0431**



100.0 × 65 × 18

**ADB0485**

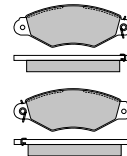

130.8 × 47.4 × 17.3

**ADB0874**



95.0 × 57.5 × 17

Where more than one part number is shown, use illustrations to determine correct pad fitment for the application



# Application Data

## Brake Pads, Wear Leads and Fitting Kits

# ANL

## Braking



WL

K

### RENAULT – cont.

**ADB0931**

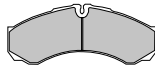

165 × 66 × 19.5

**ADB01021**

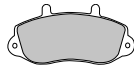

139 × 68 × 18.7

**ADB01035**

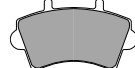

138 × 80 × 17.8

**ADB01036**



116 × 51 × 16.8

**ADB01127**



145 × 62 × 18

**ADB1133**

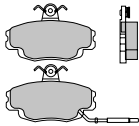

99.7 × 63.0 × 18

**ADB1183**

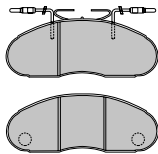

168.0 × 62.0 × 17

**ADB1431**

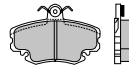

100.0 × 65.0 × 18

**ADB2258**

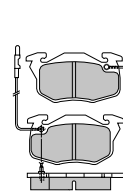

105.0 × 54.0 × 18

**ADB2485**

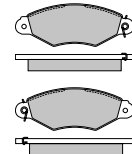

130.8 × 47.4 × 17.3

**ADB2533**

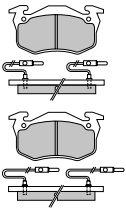

105.0 × 54.5 × 15

**ADB4311**

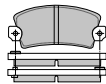

108.8 × 46.3 × 14

**ADB21048**

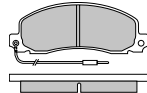

155.8 × 56.7 × 18.5

### RENAULT (RVI)

**50 Series**

S46, S56  
Manual  
Automatic

F 01/87–01/93 Lockheed  
F 01/87–01/93 Lockheed  
F 01/87–01/93 Lockheed

**ADB01066** 20904  
**ACV005** 29036

**50 Series**

S66

F 01/87–01/93 Lockheed  
F 01/87–01/93 Lockheed

**ACV005** 29036

**50 Series**

5.6T P.S.V.

F 01/87–01/93 Lockheed  
F 01/87–01/93 Lockheed

**ACV005** 29036

**B Series**

70, 90, 110

F 10/82–11/86 Bendix  
F 10/82–11/86 Bendix



**ADB0183** 29071  
**ADB1183** 29985

**B Series**

70, 90, 110 Turbo

F 11/86–01/90 Bendix  
F 11/86–01/90 Bendix



**ADB0183** 29071  
**ADB1183** 29985

Where more than one part number is shown, use illustrations to determine correct pad fitment for the application



# Application Data

## Brake Pads, Wear Leads and Fitting Kits

# ANL

## Braking

						ACV/ADB	WVA NO.	WL	K
					mm				
<b>RENAULT (RVI) – cont.</b>									
<b>B Series</b>									
B110.50, 60, B120.50, 60									
	F	01/90–01/92	Bendix		276	<b>ADB0183</b>	29071		
	F	01/90–01/92	Bendix		276	<b>ADB1183</b>	29985		
	F	01/92–01/94	Bendix		276	<b>ADB0991</b>	29706		
	F	01/92–01/94	Bendix		276	<b>ADB1991</b>	29984		
<b>Magnum Series</b>									
AE380, AE385, AE390									
4x2 models									
	F	01/90–01/93	Meritor (Lucas)		440			<b>WL022/</b> <b>WL023/</b> <b>WL024</b>	
	F	01/90–01/93	Meritor (Lucas)		440	<b>ACV015</b>	29043	<b>WL022/</b> <b>WL023/</b> <b>WL024</b>	
except D-Lisa caliper									
	F	01/93–06/00	Meritor (Lucas)		438	<b>ACV014</b> <sup>①</sup>	29030	<b>WL026</b>	<b>K002/</b> <b>K016</b>
	F	01/93–06/00	Meritor (Lucas)		438	<b>ACV030</b> <sup>②</sup>	29053	<b>WL026</b>	<b>K013/</b> <b>K016</b>
D-Lisa caliper									
	F	01/96–06/00	Meritor (Lucas)		438	<b>ACV029</b>	29090	<b>WL001/</b> <b>WL002</b>	<b>K003/</b> <b>K017</b>
<b>Note: Disc Th 45→41mm use ①, 41→38mm use ②</b>									
<b>Magnum Series</b>									
AE420, AE430, AE470									
4x2 models									
except D-Lisa caliper									
	F	01/92–06/00	Meritor (Lucas)		438	<b>ACV014</b> <sup>①</sup>	29030	<b>WL004</b>	<b>K002/</b> <b>K016</b>
	F	01/92–06/00	Meritor (Lucas)		438	<b>ACV030</b> <sup>②</sup>	29053	<b>WL004</b>	<b>K013/</b> <b>K016</b>
D-Lisa caliper									
	F	01/96–06/00	Meritor (Lucas)		438	<b>ACV029</b>	29090	<b>WL001/</b> <b>WL002</b>	<b>K003/</b> <b>K017</b>
<b>Note: Disc Th 45→41mm use ①, 41→38mm use ②</b>									
<b>Magnum Series</b>									
AE500, AE520, AE560									
4x2 models									
	F	01/92–06/00	Meritor (Lucas)		438	<b>ACV014</b> <sup>①</sup>	29030	<b>WL004</b>	<b>K002/</b> <b>K016</b>
	F	01/92–06/00	Meritor (Lucas)		438	<b>ACV030</b> <sup>②</sup>	29053	<b>WL004</b>	<b>K013/</b> <b>K016</b>
	F	01/96–06/00	Meritor (Lucas)		438	<b>ACV029</b>	29090	<b>WL001/</b> <b>WL002</b>	<b>K003/</b> <b>K017</b>
<b>Note: Disc Th 45→41mm use ①, 41→38mm use ②</b>									
<b>Magnum Series</b>									
400, 440, 480 E TECH									
D3 caliper									
	F	06/00–01/02	Meritor (Lucas)		438	<b>ACV014</b> <sup>①</sup>	29030	<b>WL004</b>	<b>K002/</b> <b>K016</b>
	F	06/00–01/02	Meritor (Lucas)		438	<b>ACV030</b> <sup>②</sup>	29053	<b>WL004</b>	<b>K013/</b> <b>K016</b>
D Elsa 2 caliper									
	F	01/02→	Meritor (Lucas)		438	<b>ACV058</b>	29131	<b>WL016</b>	<b>K002</b>
D3 caliper									
	R	06/00–01/02	Meritor (Lucas)		438	<b>ACV014</b> <sup>①</sup>	29030	<b>WL004</b>	<b>K002/</b> <b>K016</b>
	R	06/00–01/02	Meritor (Lucas)		438	<b>ACV030</b> <sup>②</sup>	29053	<b>WL004</b>	<b>K013/</b> <b>K016</b>
D Elsa 2 caliper									
	R	01/02→	Meritor (Lucas)		438	<b>ACV058</b>	29131	<b>WL016</b>	<b>K002</b>

Where more than one part number is shown, use illustrations to determine correct pad fitment for the application





















# Application Data

## Brake Pads, Wear Leads and Fitting Kits

# ANL

## Braking

						ACV/ADB	WVA NO.	WL	K
<b>RENAULT (RVI) – cont.</b> Major Series R340, R350, R380, R385	F	01/90–05/93	Meritor (Lucas)		440			WL022/ WL023/ WL024	
	F	01/90–05/93	Meritor (Lucas)		440	ACV015	29043	WL022/ WL023/ WL024	
	F	05/93–06/00	Meritor (Lucas)		438	ACV014 <sup>①</sup>	29030	WL004	K002/ K016
	F	05/93–06/00	Meritor (Lucas)		438	ACV030 <sup>②</sup>	29053	WL004	K013/ K016
<b>Note: Disc Th 45→41mm use <sup>①</sup>, 41→38mm use <sup>②</sup></b>									
<b>Major Series</b> R420, R429	F	01/90–05/93	Meritor (Lucas)		440			WL022/ WL023/ WL024	
	F	01/90–05/93	Meritor (Lucas)		440	ACV015	29043	WL022/ WL023/ WL024	
	F	05/93–06/00	Meritor (Lucas)		438	ACV014 <sup>①</sup>	29030	WL004	K002/ K016
	F	05/93–06/00	Meritor (Lucas)		438	ACV030 <sup>②</sup>	29053	WL004	K013/ K016
<b>Note: Disc Th 45→41mm use <sup>①</sup>, 41→38mm use <sup>②</sup></b>									
<b>Manager G Series</b> G230, G260, G270, G280, G290 4x2 models  except D-Lisa caliper	F	01/90–01/93	Meritor (Lucas)		440			WL022/ WL023/ WL024	
	F	01/90–01/93	Meritor (Lucas)		440	ACV015	29043	WL022/ WL023/ WL024	
	F	01/93–06/00	Meritor (Lucas)		438	ACV014 <sup>①</sup>	29030	WL004	K002/ K016
	F	01/93–06/00	Meritor (Lucas)		438	ACV030 <sup>②</sup>	29053	WL004	K013/ K016
<b>Note: Disc Th 45→41mm use <sup>①</sup>, 41→38mm use <sup>②</sup></b>									
<b>Manager G Series</b> G300, G330, G340 4x2 models  except D-Lisa caliper	F	01/90–01/93	Meritor (Lucas)		440			WL022/ WL023/ WL024	
	F	01/90–01/93	Meritor (Lucas)		440	ACV015	29043	WL022/ WL023/ WL024	
	F	01/93–06/00	Meritor (Lucas)		438	ACV014 <sup>①</sup>	29030	WL004	K002/ K016
	F	01/93–06/00	Meritor (Lucas)		438	ACV030 <sup>②</sup>	29053	WL004	K013/ K016
<b>Note: Disc Th 45→41mm use <sup>①</sup>, 41→38mm use <sup>②</sup></b>									
<b>Messenger Series</b> B110.35, 55, B120.55, 60, 65	F	01/94–06/00	Bendix		276	ADB0183	29071		
	F	01/94–06/00	Bendix		276	ADB1183	29985		

Where more than one part number is shown, use illustrations to determine correct pad fitment for the application





# Application Data

## Brake Pads, Wear Leads and Fitting Kits

# ANL Braking

				mm	ACV/ADB	WVA NO.	WL	K	
<b>RENAULT (RVI) – cont.</b> <b>Midliner</b> M120.12 → M180.13	F	01/89–05/95	S.E.E.		354	ACV009	29013		
	F	05/95→	S.E.E.		354	ACV028 <sup>①</sup>	29097		
	F	05/95→	Meritor (Lucas)			ACV033 <sup>①</sup>	29100	WL010	K004
<b>Note:</b> <sup>①</sup> Check existing pads against illustrations at rear									
<b>Midliner</b> M200.12, M250.13	F	01/89–05/95	S.E.E.		354	ACV009	29013		
	F	01/89–05/95	S.E.E.		354	ACV009	29013		
	F	05/95→	S.E.E.		354	ACV028 <sup>①</sup>	29097		
	F	05/95→	Meritor (Lucas)			ACV033 <sup>①</sup>	29100	WL010	K004
<b>Note:</b> <sup>①</sup> Check existing pads against illustrations at rear									
<b>Midliner</b> S12	F	01/87–01/91	S.E.E.		354	ACV009	29013		
<b>Midliner</b> S13	F	01/87–01/91	S.E.E.		354	ACV009	29013		
<b>Midliner</b> S120.07, S120.08	F	09/90–05/93	Meritor (Lucas)		354	ACV021 <sup>①</sup>	29065	WL025	
	F	05/93–01/95	Meritor (Lucas)		354	ACV021 <sup>①</sup>	29065	WL025	
	F	01/95→	Meritor (Lucas)		304	ACV021 <sup>①</sup>	29065	WL026	
<b>Note:</b> <sup>①</sup> Replaced by ACV032, see Technical Bulletin #001									
<b>Midliner</b> S120.09	F	09/90–01/95	Meritor (Lucas)		354	ACV011 <sup>①</sup>	21302	WL025	
	F	01/95→	Meritor (Lucas)		304	ACV011 <sup>①</sup>	21302	WL026	
<b>Note:</b> <sup>①</sup> Replaced by ACV032, see Technical Bulletin #001									
<b>Midliner</b> S130.11	F	01/86–01/91	S.E.E.		354	ACV009	29013		
	F	01/91–05/93	S.E.E.		354	ACV028	29097		
<b>Midliner</b> S130.13, S130.14	F	01/86–01/91	S.E.E.		354	ACV009	29013		
	F	01/91–05/93	S.E.E.		354	ACV028	29097		
<b>Midliner</b> S135.07, S135.08, S135.09	F	05/93–01/95	Meritor (Lucas)		354	ACV021 <sup>①</sup>	29065	WL025	
	F	01/95→	Meritor (Lucas)		304	ACV021 <sup>①</sup>	29065	WL026	
<b>Note:</b> <sup>①</sup> Replaced by ACV032, see Technical Bulletin #001									
<b>Midliner</b> S140.07	F	09/91–05/93	Meritor (Lucas)		354	ACV021 <sup>①</sup>	29065	WL025	
<b>Note:</b> <sup>①</sup> Replaced by ACV032, see Technical Bulletin #001									
<b>Midliner</b> S140.09	F	05/93–01/95	Meritor (Lucas)		354	ACV021 <sup>①</sup>	29065	WL025	
	F	01/95→	Meritor (Lucas)		304	ACV021 <sup>①</sup>	29065	WL026	
<b>Note:</b> <sup>①</sup> Replaced by ACV032, see Technical Bulletin #001									
<b>Midliner</b> S150.07, S150.08	F	05/93–01/95	Meritor (Lucas)		354	ACV021 <sup>①</sup>	29065	WL025	
	F	01/95→	Meritor (Lucas)		304	ACV021 <sup>①</sup>	29065	WL026	
<b>Note:</b> <sup>①</sup> Replaced by ACV032, see Technical Bulletin #001									
<b>Midliner</b> S150.09, S150.10	F	05/93–01/95	Meritor (Lucas)		354	ACV011 <sup>①</sup>	21302	WL025	
	F	01/95→	Meritor (Lucas)		304	ACV011 <sup>①</sup>	21302	WL026	
<b>Note:</b> <sup>①</sup> Replaced by ACV032, see Technical Bulletin #001									

Where more than one part number is shown, use illustrations to determine correct pad fitment for the application



# Application Data

## Brake Pads, Wear Leads and Fitting Kits

# ANL

## Braking

						ACV/ADB	WVA NO.	WL	K
						mm			
<b>RENAULT (RVI) – cont.</b> Midliner S150.11, S150.13	F	01/86–01/91	S.E.E.		354	<b>ACV009</b>	29013		
	F	01/91–05/93	S.E.E.		354	<b>ACV028</b>	29097		
Midliner S160.06, S160.08 Note: ① Replaced by ACV032, see Technical Bulletin #001	F	09/91–05/93	Meritor (Lucas)		354	<b>ACV021</b> ①	29065	<b>WL025</b>	
Midliner S160.09 Note: ① Replaced by ACV032, see Technical Bulletin #001	F	09/91–01/95	Meritor (Lucas)		354	<b>ACV011</b> ①	21302	<b>WL025</b>	
	F	01/95→	Meritor (Lucas)		322	<b>ACV011</b> ①	21302	<b>WL026</b>	
Midliner S170.11, S170.13	F	01/86–01/91	S.E.E.		354	<b>ACV009</b>	29013		
	F	01/91–05/93	S.E.E.		354	<b>ACV028</b>	29097		
Midliner S180.07, S180.08 Note: ① Replaced by ACV032, see Technical Bulletin #001	F	01/91–01/95	Meritor (Lucas)		354	<b>ACV021</b> ①	29065	<b>WL025</b>	
	F	01/95→	Meritor (Lucas)		322	<b>ACV021</b> ①	29065	<b>WL026</b>	
Midliner S180.09, S180.10 Note: ① Replaced by ACV032, see Technical Bulletin #001	F	01/91–01/95	Meritor (Lucas)		354	<b>ACV011</b> ①	21302	<b>WL025</b>	
	F	01/95→	Meritor (Lucas)		322	<b>ACV011</b> ①	21302	<b>WL026</b>	
Midliner S210.07, S210.08 Note: ① Replaced by ACV032, see Technical Bulletin #001	F	01/91–01/95	Meritor (Lucas)		354	<b>ACV021</b> ①	29065	<b>WL025</b>	
	F	01/95→	Meritor (Lucas)		322	<b>ACV021</b> ①	29065	<b>WL026</b>	
Midliner S210.09, S210.10 Note: ① Replaced by ACV032, see Technical Bulletin #001	F	01/91–01/95	Meritor (Lucas)		354	<b>ACV011</b> ①	21302	<b>WL025</b>	
	F	01/95→	Meritor (Lucas)		322	<b>ACV011</b> ①	21302	<b>WL026</b>	
Midlum →02 180.10, 180.10B Note: Disc Th 30→26mm use ①, 26→24mm use ②	F	11/99–01/02	Wabco / Perrot		330	<b>ACV039</b> ①	29088	<b>WL012</b>	<b>K006</b>
	F	11/99–01/02	Wabco / Perrot		330	<b>ACV040</b> ②	29091	<b>WL012</b>	<b>K006</b>
	R	11/99–01/02	Wabco / Perrot		330	<b>ACV039</b> ①	29088	<b>WL012</b>	<b>K006</b>
	R	11/99–01/02	Wabco / Perrot		330	<b>ACV040</b> ②	29091	<b>WL012</b>	<b>K006</b>
Midlum 02→ 130, 150 Series 7.5T Note: Disc Th 30→26mm use ①, 26→24mm use ②	F	01/02→	Wabco / Perrot		330	<b>ACV039</b> ①	29088	<b>WL012</b>	<b>K006</b>
	F	01/02→	Wabco / Perrot		330	<b>ACV040</b> ②	29091	<b>WL012</b>	<b>K006</b>
	R	01/02→	Wabco / Perrot		330	<b>ACV039</b> ①	29088	<b>WL012</b>	<b>K006</b>
	R	01/02→	Wabco / Perrot		330	<b>ACV040</b> ②	29091	<b>WL012</b>	<b>K006</b>
Midlum 02→ 180 Series 7.5T→16T 17.5" wheels 19.5" wheels	F	01/02→	Wabco / Perrot		330	<b>ACV039</b> ①	29088	<b>WL012</b>	<b>K006</b>
	F	01/02→	Wabco / Perrot		330	<b>ACV040</b> ②	29091	<b>WL012</b>	<b>K006</b>
	F	01/02→	Meritor (Lucas)			<b>ACV033</b>	29100	<b>WL010</b>	<b>K004</b>
	F	01/02→	Wabco / Perrot			<b>ACV060</b>	29142	<b>WL018/ WL020</b>	<b>K015</b>

Where more than one part number is shown, use illustrations to determine correct pad fitment for the application



# Application Data

## Brake Pads, Wear Leads and Fitting Kits

### ANL Braking

						ACV/ADB	WVA NO.	WL	K
					mm				
<b>RENAULT (RVI) – cont.</b> Midlum 02→ – cont. 17.5" wheels 19.5" wheels	R	01/02→	Wabco / Perrot		330	ACV039 <sup>①</sup>	29088	WL012	K006
	R	01/02→	Wabco / Perrot		330	ACV040 <sup>②</sup>	29091	WL012	K006
	R	01/02→	Meritor (Lucas)			ACV033	29100	WL010	K004
	R	01/02→	Wabco / Perrot			ACV060	29142	WL018/ WL020	K015
<b>Note: Disc Th 30→26mm use ①, 26→24mm use ②</b>									
<b>Midlum 02→</b> 200, 210, 220, 250 Series 7.5T→16T 17.5" wheels 19.5" wheels 17.5" wheels 19.5" wheels	F	01/02→	Wabco / Perrot		330	ACV039 <sup>①</sup>	29088	WL012	K006
	F	01/02→	Wabco / Perrot		330	ACV040 <sup>②</sup>	29091	WL012	K006
	F	01/02→	Meritor (Lucas)			ACV033	29100	WL010	K004
	F	01/02→	Wabco / Perrot			ACV060	29142	WL018/ WL020	K015
	R	01/02→	Wabco / Perrot		330	ACV039 <sup>①</sup>	29088	WL012	K006
	R	01/02→	Wabco / Perrot		330	ACV040 <sup>②</sup>	29091	WL012	K006
	R	01/02→	Meritor (Lucas)			ACV033	29100	WL010	K004
	R	01/02→	Wabco / Perrot			ACV060	29142	WL018/ WL020	K015
<b>Note: Disc Th 30→26mm use ①, 26→24mm use ②</b>									
<b>Premium →02</b> 210, 250, 260 D3 caliper D-Lisa caliper	F	01/96–01/02	Meritor (Lucas)		438	ACV014 <sup>①</sup>	29030	WL001/ WL002	K002/ K016
	F	01/96–01/02	Meritor (Lucas)		438	ACV030 <sup>②</sup>	29053	WL001/ WL002	K013/ K016
	F	01/96–01/02	Meritor (Lucas)		438	ACV029	29090	WL001/ WL002	K003/ K017
<b>Premium →02</b> 300, 340, 385 D3 caliper D-Lisa caliper	F	01/96–01/02	Meritor (Lucas)		438	ACV014 <sup>①</sup>	29030	WL001/ WL002	K002/ K016
	F	01/96–01/02	Meritor (Lucas)		438	ACV030 <sup>②</sup>	29053	WL001/ WL002	K013/ K016
	F	01/96–01/02	Meritor (Lucas)		438	ACV029	29090	WL001/ WL002	K003/ K017
<b>Premium 02→</b> 200 Series D Elsa 2 caliper	F	01/02→	Meritor (Lucas)		438	ACV058	29131	WL016	K002
<b>Premium 02→</b> 300 Series D Elsa 2 caliper	F	01/02→	Meritor (Lucas)		438	ACV058	29131	WL016	K002
	R	01/02→	Meritor (Lucas)		438	ACV058	29131	WL016	K002
<b>Premium 02→</b> 400 Series D Elsa 2 caliper	F	01/02→	Meritor (Lucas)		438	ACV058	29131	WL016	K002
	R	01/02→	Meritor (Lucas)		438	ACV058	29131	WL016	K002

Where more than one part number is shown, use illustrations to determine correct pad fitment for the application



# Application Data

## Brake Pads, Wear Leads and Fitting Kits

# ANL Braking

<b>RENAULT (RVI) – cont.</b> PSV Agora D3 caliper  D-Lisa caliper	F	01/95→	Meritor (Lucas)		438	ACV014 <sup>Ⓢ</sup>	29030	WL001	K002/ K016
	F	01/95→	Meritor (Lucas)		438	ACV030 <sup>Ⓢ</sup>	29053	WL001	K013/ K016
	F	01/95→	Meritor (Lucas)		438	ACV029	29090	WL001	K003/ K017
<b>PSV FR1 Bus</b>	F	01/84→	S.E.E.		400	ACV013	29044		
<b>PSV Illiade</b>  D3 caliper  D Elsa 2 caliper  D3 caliper  D Elsa 2 caliper	F	01/97–01/98	S.E.E.		400	ACV013	29044		
	F	01/98–06/00	Meritor (Lucas)		438	ACV014 <sup>Ⓢ</sup>	29030	WL001	K002/ K016
	F	01/98–06/00	Meritor (Lucas)		438	ACV030 <sup>Ⓢ</sup>	29053	WL001	K013/ K016
	F	06/00→	Meritor (Lucas)		438	ACV058	29131	WL016	K002
	R	01/98–06/00	Meritor (Lucas)		438	ACV014 <sup>Ⓢ</sup>	29030	WL001	K002/ K016
	R	01/98–06/00	Meritor (Lucas)		438	ACV030 <sup>Ⓢ</sup>	29053	WL001	K013/ K016
<b>PSV Midliner</b> PP160.09 <b>Note:</b> <sup>Ⓢ</sup> Replaced by ACV032, see Technical Bulletin #001	F	01/92–05/93	Meritor (Lucas)		354	ACV011 <sup>Ⓢ</sup>	21302	WL025	
	F	01/89→	Brembo		350	ACV008	29072		
			Brembo		350	ACV008	29072		
<b>R Series</b> R380, R420	F	01/89–01/92	Meritor (Lucas)		440	ACV015	29043	WL022	
	F	01/89–01/92	Meritor (Lucas)		440				

**ACV005**

161.0 × 70.0 × 24

**ACV008**

169.8 × 98.0 × 19

**ACV009**

180.0 × 86.0 × 21.5

**ACV011**

Replaced by ACV032

175.0 × 77.0 × 22

**ACV013**

236.0 × 95.0 × 20

Where more than one part number is shown, use illustrations to determine correct pad fitment for the application



# Application Data

## Brake Pads, Wear Leads and Fitting Kits

# ANL Braking



mm



ACV/ADB

WVA NO.

WL

K



### RENAULT (RVI) – cont.

ACV014

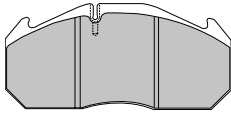

250.0 × 118.0 × 28

ACV015

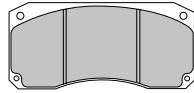

204.0 × 96.0 × 24

ACV021

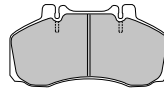

175.0 × 85.5 × 22

Replaced by **ACV032**

ACV028

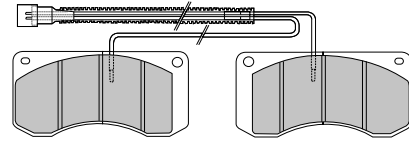

180.0 × 86.0 × 20.5

ACV029

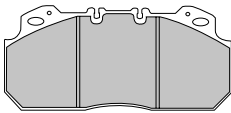

250.0 × 114.0 × 28

ACV030

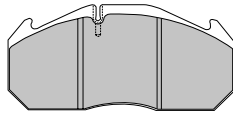

250.0 × 118.0 × 28

ACV033

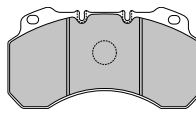

214 × 112 × 25

ACV039

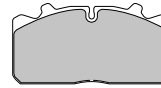

175.6 × 85.6 × 26

ACV040



175.6 × 85.6 × 27

ACV058

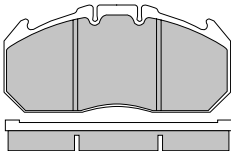

250.0 × 118.0 × 30

ACV060

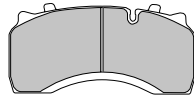

204.6 × 99.6 × 30

ADB0183

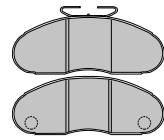

168.0 × 62.0 × 17

ADB0991

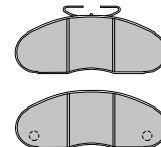

168.0 × 62.0 × 16.5

ADB01066

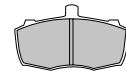

126.7 × 71.2 × 18

ADB1183

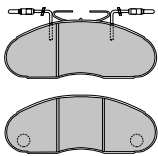

168.0 × 62.0 × 17

ADB1991

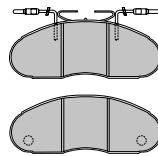

168.0 × 62.0 × 16.5

**R.O.R.**  
see MERITOR

**ROVER**

Maestro Van

F

01/84–01/94

Lucas



240

ADB1396

21084





















Where more than one part number is shown, use illustrations to determine correct pad fitment for the application

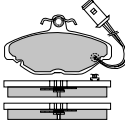

# Application Data

## Brake Pads, Wear Leads and Fitting Kits

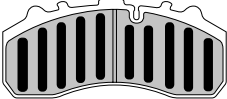
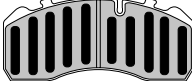
# ANL Braking



















						ACV/ADB	WVA NO.	WL	K
						mm			
   									
<b>ROVER – cont.</b> Metro Van	F	01/82–01/84	Lockheed		213	<b>ADB1392</b>	20754		
	F	01/90–01/95	Lucas		240	<b>ADB0467</b>	21518		
	F	01/84–01/90	Lockheed		213	<b>ADB1392</b>	20754		
	F	01/90–01/95	Lucas		240	<b>ADB0467</b>	21518		
<b>Morris</b> Ital 440 Van / Pick-up	F	01/82–01/84	Lucas		248		20089		
<b>Morris</b> Marina 440 Van	F	01/78–01/82	Lucas		248		20089		
<b>ADB0467</b>									
									
114.9 × 59.8 × 17									
<b>ADB1392</b>									
									
83.9 × 56.0 × 14.5									
<b>ADB1396</b>									
									
118.5 × 64.5 × 17.5									
<b>SAE DUPILLIER</b>									
with Knorr brakes SB 5000		01/99→	Knorr			<b>ACV038</b>	29115		<b>K005/ K018</b>
with Knorr brakes SB 6000		01/99→	Knorr		377	<b>ACV043<sup>①</sup></b>	29095	<b>WL015</b>	<b>K005/ K018</b>
		01/99→	Knorr		377	<b>ACV044<sup>②</sup></b>	29095	<b>WL015</b>	<b>K005/ K018</b>
<b>Note: Disc Th 45→41mm use <sup>①</sup>, 41→38mm use <sup>②</sup></b>									
with Knorr brakes SB 7000		01/99→	Knorr		430	<b>ACV042</b>	29108		<b>K005/ K018</b>
<b>ACV038</b>									
									
173.6 × 84 × 34.00/27.00									
<b>ACV042</b>									
									
248.0 × 108.0 × 30									
<b>ACV043</b>									
									
210.7 × 92.5 × 30									
<b>ACV044</b>									
									
210.7 × 92.5 × 30									
<b>SAF / SAUER</b>									
with Haldex brakes SK/RS 9022 10 hole disc		01/99→	Haldex		430	<b>ACV054</b>	29143		<b>K012</b>
<b>Where more than one part number is shown, use illustrations to determine correct pad fitment for the application</b>									

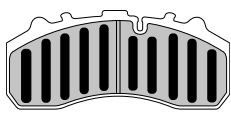
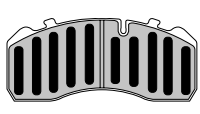
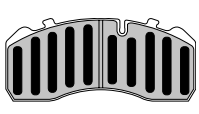

# Application Data

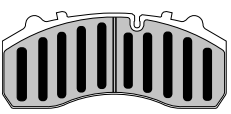
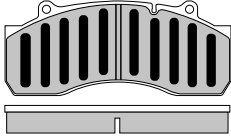
## Brake Pads, Wear Leads and Fitting Kits

# ANL Braking

						ACV/ADB	WVA NO.	WL	K
						mm			
									
<b>SAF / SAUER – cont.</b> with Haldex brakes SK/RB 9022 12 hole disc						430	ACV054	29143	K012
with Knorr brakes SB 6000		01/99→	Knorr		377	ACV043 <sup>①</sup>	29095	WL015	K005/ K018
		01/99→	Knorr		377	ACV044 <sup>②</sup>	29095	WL015	K005/ K018
<b>Note: Disc Th 45→41mm use ①, 41→38mm use ②</b>									
with Knorr brakes SB 7000		01/99→	Knorr		430	ACV042	29108		K005/ K018
with Wabco / Perrot brakes PAN 19-1		01/99→	Wabco / Perrot		377	ACV048	29126		K008
with Wabco / Perrot brakes PAN 22		01/99→	Wabco / Perrot		430	ACV049	29146		K009
<b>ACV042</b>	<b>ACV043</b>	<b>ACV044</b>	<b>ACV048</b>	<b>ACV049</b>					
									
248.0 × 108.0 × 30	210.7 × 92.5 × 30	210.7 × 92.5 × 30	210 × 93 × 30	247 × 107 × 30					
<b>ACV054</b>									
									
248 × 105 × 30									
<b>SCANIA</b>									
<b>S 4 Series</b> 94, 114, 124, 144	F	01/96→	Knorr		430	ACV041	29106	WL009	K005/ K018
	R	01/96→	Knorr		430	ACV041	29106	WL009	K005/ K018
<b>PSV with Knorr brakes</b> SB 7000	F	01/96→	Knorr		430	ACV041	29106	WL009	K005/ K018
	R	01/96→	Knorr		430	ACV041	29106	WL009	K005/ K018

Where more than one part number is shown, use illustrations to determine correct pad fitment for the application



# Application Data

## Brake Pads, Wear Leads and Fitting Kits

# ANL

## Braking

					ACV/ADB	WVA NO.	WL	K
<b>SCANIA – cont.</b>								
PSV Omnicity with Knorr brakes								
F	01/96→	Knorr		430	ACV041	29106	WL009	K005/ K018
R	01/96→	Knorr		430	ACV041	29106	WL009	K005/ K018
<p><b>ACV041</b></p> <p>248.0 × 108.0 × 30</p>								
<b>SEAT</b>								
Inca 1.4i, 1.6i, 1.9 D								
F	01/96→	VW 2		256	ADB0149	20887		
F	01/96→	Lucas		256	ADB0511	20168		
Terra / Vista								
F	07/89–10/95	Bendix		227	ADB0129	20950		
F	07/89–10/95	Bendix		227	ADB4129	20950		
<p><b>ADB0129</b>      <b>ADB0149</b>      <b>ADB0511</b>      <b>ADB4129</b></p> <p>108.9 × 48.0 × 18      137.7 × 50.0 × 19.5      119.0 × 69.0 × 19.3      108.9 × 48.0 × 18</p>								
<b>SEDDON ATKINSON</b>								
Strato T6 345→T6 420 4x2 Tractor, 6x2 Tractor								
F		Meritor (Lucas)						
R		Meritor (Lucas)						
Strato T7 345→T7 420 4x2 Tractor, 6x2 Tractor								
F		Meritor (Lucas)						
R		Meritor (Lucas)						
Stratocruiser T7 345→T7 420 4x2 Tractor, 6x2 Tractor								
F		Meritor (Lucas)						-cont.

Where more than one part number is shown, use illustrations to determine correct pad fitment for the application





# Application Data

## Brake Pads, Wear Leads and Fitting Kits

# ANL Braking



Vehicle / Application	Wheel	Year Range	Manufacturer	Wear Lead	Thickness (mm)	ACV/ADB	WVA NO.	WL	K
<b>SEDDON ATKINSON – cont.</b> Stratocruiser – cont.	R		Meritor (Lucas)						
<b>SICCA</b>									
PSV 166, 177	F	01/78→	Wabco / Perrot		425		29016		
<b>SKODA</b>									
Cube Van 1.9 Diesel	F	01/98→	Ate / VW 3		239	<b>ADB0707</b>	21866		
Favorit Van	F	01/91–01/93	Lucas		236	<b>ADB0928</b>	20861		
	F	01/93–04/94	Lucas		236	<b>ADB0928</b>	20861		
	F	04/94–10/96	Lucas		236	<b>ADB0928</b>	20861		
Forman 1.3 Pick-Up	F	01/92–01/93	Lucas		236	<b>ADB0928</b>	20861		
	F	01/93–04/94	Lucas		236	<b>ADB0928</b>	20861		
	F	04/94→	Lucas		236	<b>ADB0928</b>	20861		

**ADB0707**

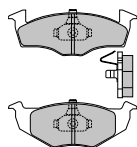

141.8 × 51.2 × 17

**ADB0928**

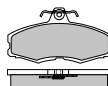

114.9 × 60.5 × 17.5

<b>SMB AXLES</b> see FRUEHAUF									
----------------------------------	--	--	--	--	--	--	--	--	--

<b>STEYR-DAIMLER-PUCH</b>									
---------------------------	--	--	--	--	--	--	--	--	--

SC 6 F 72 Citybus	F	01/87→	Ate			<b>ADB0312</b>	20323		
----------------------	---	--------	-----	--	--	----------------	-------	--	--

**ADB0312**



76.7 × 65.7 × 16.5

Where more than one part number is shown, use illustrations to determine correct pad fitment for the application



# Application Data

## Brake Pads, Wear Leads and Fitting Kits

# ANL Braking

<b>SUBARU</b>									
<b>1000, 1200 Van (E 10 Series)</b> 2x4, 4x4	F	01/84-01/90							
<b>Brat / M.V.</b> 2x4 1.6 (AU2) Pick-up	F	01/81-01/82	Akebono		230	<b>ADB3399</b>	20766		
<b>Brat / M.V.</b> 4x4 1.6 (A68 / AS3) Pick-up	F	01/77-01/81	Akebono		229				
<b>Brat / M.V.</b> 4x4 1.8 (AS5) Pick-up	F	01/80-01/81	Akebono		229				
<b>Brat / M.V.</b> 4x4 1.8 (AU5) Pick-up	F	01/81-08/83	Akebono		230	<b>ADB3399</b>	20766		
	F	08/83-01/87	Akebono		230	<b>ADB3400</b>	20767		
	F	01/87→							
<b>E-Wagon</b> 1.2	F	06/94→	Bendix		221	<b>ADB0952</b>			
<b>Justy Van</b> 1.2	F	02/86-01/89	Sumitomo		212	<b>ADB0207</b>	20958		
	F	02/86-01/89	Sumitomo		212	<b>ADB3207</b>	21224		
	F	02/86-01/89	Sumitomo		212	<b>ADB0207</b>	20958		
	F	02/86-01/89	Sumitomo		212	<b>ADB3207</b>	21224		
12" wheels	F	01/89-03/96	Sumitomo		212	<b>ADB3402</b>	21549		
13" wheels	F	01/89-03/96	Akebono		240	<b>ADB3451</b>	21709		
<b>Justy Van</b> 1.3i 4x4	F	03/96→	Akebono		231	<b>ADB3518</b>	21333		
<b>Mini Jumbo</b> DL, SDX	F	01/82-01/88	Sumitomo		212	<b>ADB0207</b>	20958		
	F	01/82-01/88	Sumitomo		212	<b>ADB3207</b>	21224		
	F	01/88-01/90	Akebono			<b>ADB0552</b>	21542		
	R	01/88-01/90							
<b>Sumo</b> 1.0 Van (KJ5)	F	01/88-05/94	Sumitomo		212	<b>ADB0207</b>	20958		
	F	01/88-05/94	Sumitomo		212	<b>ADB3207</b>	21224		
	F	01/88-05/94	Sumitomo		212	<b>ADB0207</b>	20958		
	F	01/88-05/94	Sumitomo		212	<b>ADB3207</b>	21224		
<b>Sumo</b> 1.2 Van (KJ8)	F	01/88-05/94	Sumitomo		212	<b>ADB0207</b>	20958		
	F	01/88-05/94	Sumitomo		212	<b>ADB3207</b>	21224		
	F	01/88-05/94	Sumitomo		212	<b>ADB0207</b>	20958		
	F	01/88-05/94	Sumitomo		212	<b>ADB3207</b>	21224		

Where more than one part number is shown, use illustrations to determine correct pad fitment for the application



# Application Data

## Brake Pads, Wear Leads and Fitting Kits

# ANL Braking

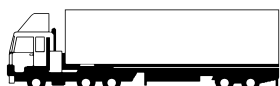

WVA  
NO.

WL

K

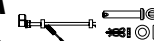

### SUBARU – cont.

ADB0207



108.6 × 40.5 × 16

ADB0552



103.2 × 39.0 × 14

ADB0952

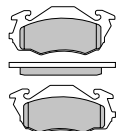

120 × 53 × 14.8

ADB3207

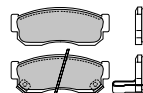

108.6 × 40.5 × 16

ADB3399

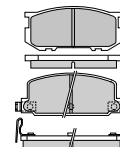

106.9 × 48.4 × 14

ADB3400

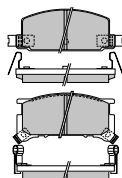

106.9 × 48.4 × 15

ADB3402

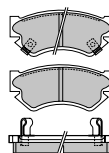

108.8 × 48.0 × 14.8

ADB3451

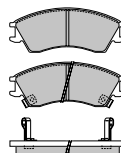

127.2 × 49.2 × 15.5

ADB3518

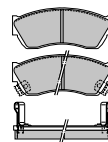

107.3 × 44.4 × 15

### SUZUKI

Carry (GA, DA series)  
1.3i

F 07/00→



ADB31113 23507

Carry (GA, DA series)  
1.3i 4x4

F 07/00→



ADB31113 23507

Jimny Van  
1.3

F 10/98→

Sumitomo

ADB0195 21142

R 10/98→

Jimny Van  
1.3i 4x4

F 02/00→

Sumitomo



ADB0195 21142

Supercarry  
1.0 (SK410) Pick-up, Van

F 01/86–01/95

Sumitomo



215

ADB0130 20731

Supercarry  
1.0 (DA21) Pick-up, Van

F 01/95→



215

ADB0734

Vitara Van  
1.6 (SE416) JLX 4x4

F 01/93→

Akebono



290

ADB3273 21502

F 01/93→

Lucas



290

ADB1204 20708

F 01/93→

Akebono



290

ADB3587 21907

Where more than one part number is shown, use illustrations to determine correct pad fitment for the application



# Application Data

## Brake Pads, Wear Leads and Fitting Kits

# ANL

## Braking

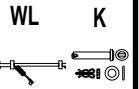

### SUZUKI – cont.

**ADB0130**



119.3 × 37.7 × 15.5

**ADB0195**



110.5 × 41.5 × 15

**ADB0734**



101.8 × 39.8 × 15.3

**ADB1204**

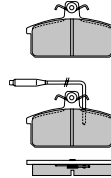

99.3 × 61.5 × 16.5

**ADB3273**

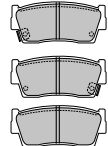

103.5 × 44.0 × 15

**ADB3587**

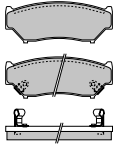

117.0 × 45.0 × 15

**ADB31113**

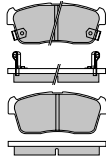

108.7 × 45.5 × 15

### TALBOT

**Express**

1.8 Petrol

F	01/82–01/84	Lucas		256	<b>ADB1254</b>	20741
F	01/84–01/86	Lucas		256	<b>ADB1254</b>	20741
F	01/86–01/89	Lucas		256		21205

**Express**

1.9 Diesel

F	01/87–01/94	Lucas		256		21205
---	-------------	-------	--	-----	--	-------

**Express**

2.0 Petrol  
except 350

F	01/82–01/84	Lucas		256	<b>ADB1254</b>	20741
F	01/84–01/86	Lucas		256	<b>ADB1254</b>	20741
F	01/86–01/94	Lucas		256		21205
F	01/90–01/94	Wabco / Perrot		290	<b>ADB1235</b>	29040

350

**Express**

2.5 Diesel  
except 350  
350

F	01/86–01/94	Lucas		256		21205
F	01/90–01/94	Wabco / Perrot		290	<b>ADB1235</b>	29040

**Express**

2.5 Turbo Diesel

F	01/87–01/94	Lucas		290		21205
F	01/87–01/94	Wabco / Perrot		290	<b>ADB1235</b>	29040

Where more than one part number is shown, use illustrations to determine correct pad fitment for the application



# Application Data

## Brake Pads, Wear Leads and Fitting Kits

# ANL

## Braking

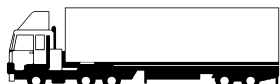

**WVA NO.**

WL

K



### TALBOT – cont.

**ADB1235**

**ADB1254**

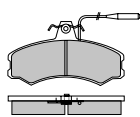
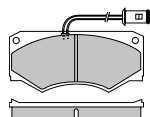

149.0 × 69.0 × 18

130.0 × 71.5 × 19

### TATA

**Loadbeta Pick-Up, Van**  
2.0 Diesel

F 10/94→

Lucas

**ADB0256**

21245

R 10/94→

**ADB0256**

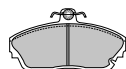

129 × 68 × 17.5

### TAXIS

**LTI Carbodies**

FX4, Fairway, Fairway Driver  
with disc conversion

F 01/59–01/92

Lucas



20027

F 01/59–01/92

Lucas



20027

F 01/92–07/96

Lockheed



278

**ADB0401**

21459

F 01/92–07/96

Lockheed



278

**ADB1401**

21459

F 07/96→

Lockheed



278

**ADB0319**

20359

**MCW**

Metro Cab

F 08/91→

Lockheed



284

**ADB0401**

21459

**Optare**

City Pacer

F 01/86→

Ate



281

20280

Where more than one part number is shown, use illustrations to determine correct pad fitment for the application



# Application Data

## Brake Pads, Wear Leads and Fitting Kits

# ANL

## Braking



WL

K

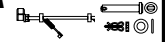

### TAXIS – cont.

ADB0319



104.9 × 74.7 × 18

ADB0401

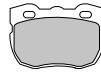

104.9 × 72.4 × 18

ADB1401

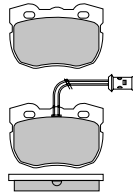

104.9 × 72.4 × 18

### TOYOTA

#### Dyna

2.0 (YU60)

F 01/84–08/87  
R 01/84–08/87

Akebono

ADB0264

20729

#### Dyna

3.4 (BU75, BU85)

F 01/84–08/87  
R 01/84–08/87

Akebono

ADB0264

20729

#### Dyna 100

1.8 (YH81)

F 01/87–09/88  
F 09/88→

Akebono  
Sumitomo



257  
257

ADB0297  
ADB0459

21158  
21468

#### Dyna 100

2.4 (LH80, LH81)

F 01/87–09/88  
F 09/88→

Akebono  
Sumitomo



257  
257

ADB0297  
ADB0459

21158  
21468

#### Dyna 150

2.0 (YY60, YY61)

F 08/85–09/88  
R 08/85–09/88

Sumitomo

21855

#### Dyna 150

2.4 (LY60)

F 08/85–08/87  
F 08/87–09/88  
R 08/85–09/88

Sumitomo  
Sumitomo

21855

#### Dyna 150

3.4 (LY61)

F 09/88→  
F 09/88→  
R 09/88→

Sumitomo  
Sumitomo

21855

#### Hi-Ace (→89)

1.6 (RH11, 20, 30)

F 01/77–01/86

Akebono



252

ADB0264

20729

#### Hi-Ace (→89)

1.8 (YH61)

F 01/83–01/85

Akebono



257

ADB0297

21158

#### Hi-Ace (→89)

2.0 (RH32)

F 01/78–01/83

Akebono



252

ADB0264

20729

Where more than one part number is shown, use illustrations to determine correct pad fitment for the application



# Application Data

## Brake Pads, Wear Leads and Fitting Kits

# ANL Braking

						ACV/ADB	WVA NO.	WL	K
						mm			
<b>TOYOTA – cont.</b>									
<b>Hi-Ace (→89)</b> 2.0 (YH51, 56, 61, 66) except 4x4 4x4	F	01/83–01/89	Akebono		257	<b>ADB0297</b>	21158		
	F	01/86–01/89	Sumitomo			<b>ADB0459</b>	21468		
<b>Hi-Ace (→89)</b> 2.2 (LH11, LH60)	F	01/80–01/83	Akebono		252	<b>ADB0297</b>	21158		
	F	01/83–01/85	Akebono		257	<b>ADB0297</b>	21158		
<b>Hi-Ace (→89)</b> 2.4 (LH51, LH61, LH66)	F	01/83–01/89	Akebono		257	<b>ADB0297</b> <sup>⓪</sup>	21158		
	F	01/83–01/89	Sumitomo		287	<b>ADB0459</b> <sup>⓪</sup>	21468		
<b>Note: ⓪ Use illustrations to determine correct pad fitment</b>									
<b>Hi-Ace (89-93)</b> 2.0 except 4x4 4x4	F	01/89–01/93	Sumitomo		255	<b>ADB0440</b>	21689		
	F	01/89–01/93	Sumitomo			<b>ADB0459</b>	21468		
<b>Hi-Ace (89-93)</b> 2.4 except 4x4 4x4	F	01/89–01/93	Sumitomo		255	<b>ADB0440</b>	21689		
	F	01/89–01/93	Sumitomo		287	<b>ADB0459</b>	21468		
<b>Hi-Ace (93-96)</b> 2.0 except 4x4 4x4	F	01/93–01/96	Sumitomo		255	<b>ADB0440</b>	21689		
	F	01/93–01/96	Sumitomo			<b>ADB0459</b>	21468		
<b>Hi-Ace (93-96)</b> 2.4 except 4x4 4x4	F	01/93–01/96	Sumitomo		255	<b>ADB0440</b>	21689		
	F	01/93–01/96	Sumitomo		287	<b>ADB0459</b>	21468		
<b>Hi-Ace Power Van 96→</b> 2.0 except 4x4 4x4	F	01/96→	Sumitomo			<b>ADB0440</b>	21689		
	F	01/96→	Sumitomo			<b>ADB0459</b>	21468		
<b>Hi-Ace Power Van 96→</b> 2.4 except 4x4 4x4	F	01/96→	Sumitomo			<b>ADB0440</b>	21689		
	F	01/96→	Sumitomo		285	<b>ADB0459</b>	21468		
<b>Hi-Lux (→88)</b> 1.6 (RN40 - RWD)	F	01/78–01/83	Akebono		252	<b>ADB0264</b>	20729		
<b>Hi-Lux (→88)</b> 1.8 (YN56 - RWD)	F	01/84–01/88	Akebono		257	<b>ADB0297</b>	21158		
<b>Hi-Lux (→88)</b> 2.0 (RN46 - 4x4)	F	09/80–01/84	Sumitomo		266	<b>ADB0265</b>	20852		
	F	09/80–01/84	Sumitomo		302	<b>ADB0265</b>	20852		
<b>Hi-Lux (→88)</b> 2.0 (YN65 - 4x4)	F	01/84–01/86	Sumitomo		302	<b>ADB0265</b>	20852		
<b>Hi-Lux (→88)</b> 2.2 (YN67 - 4x4)	F	01/86–01/88	Sumitomo		302	<b>ADB0265</b>	20852		
<b>Hi-Lux (→88)</b> 2.4 (LN65 - 4x4)	F	01/84–01/88	Sumitomo		302	<b>ADB0265</b>	20852		

Where more than one part number is shown, use illustrations to determine correct pad fitment for the application



# Application Data

## Brake Pads, Wear Leads and Fitting Kits

# ANL Braking

						ACV/ADB mm	WVA NO.	WL	K
<b>TOYOTA – cont.</b> <b>Hi-Lux (88-94)</b> 1.8 (YN85 - RWD)	F	08/88–09/94	Sumitomo		257	<b>ADB31090</b>	21784		
	F	08/88–09/94	Sumitomo		257				
<b>Hi-Lux (88-94)</b> 2.0, 2.2 (RN, YN106, RN, YN110 - 4x4)	F	08/88–09/94	Sumitomo			<b>ADB3333</b>	21680		
<b>Hi-Lux (88-94)</b> 2.4 (LN105, RN106 - 4x4)	F	08/88–09/94	Sumitomo			<b>ADB3333</b>	21680		
<b>Hi-Lux (94→)</b> 2.2 (RN106, RN110)	F	09/94→	Sumitomo			<b>ADB3333</b>	21680		
<b>Hi-Lux (94→)</b> 2.4 (LN85, LN90, LN108, LN110) except 4x4  4x4	F	09/94→	Sumitomo			<b>ADB31090</b>	21784		
	F	09/94→	Sumitomo						
	F	09/94→	Sumitomo			<b>ADB3333</b>	21680		
<b>Lite-Ace</b> 1.3 (KM20)	F	01/79–01/82	Akebono						
	F	11/82–01/86	Akebono		230	<b>ADB3422</b>	20182		
<b>Lite-Ace</b> 1.5 (KM30, KM36) with single piston caliper with twin piston caliper with single piston caliper with twin piston caliper	F	01/86–08/88	Akebono		255	<b>ADB3422</b>	20182		
	F	01/86–08/88	Akebono		255	<b>ADB0589</b>	21249		
	F	08/88–01/92	Akebono		255	<b>ADB3422</b>	20182		
	F	08/88–01/92	Akebono		255	<b>ADB0589</b>	21249		
	R	01/86–01/92							
<b>Lite-Ace</b> 1.5 (KR21)	F	01/92→	Akebono		255	<b>ADB3746</b>	21837		
<b>Lite-Ace</b> 1.5 (KR27)	F	01/92→	Akebono		255	<b>ADB3422</b>	20182		
	R	01/92→							
<b>Lite-Ace</b> 1.8 (YM21)	F	11/82–01/86	Akebono		230	<b>ADB3422</b>	20182		
<b>Lite-Ace</b> 2.0 (CR27)	F	01/92→	Akebono		255	<b>ADB3422</b>	20182		
<b>Lite-Ace</b> 2.0 D (CM30)	F	01/92→	Akebono		255	<b>ADB0589</b>	21249		
<b>Lite-Ace</b> 2.0 D (CR21)	F	01/92→	Akebono		255	<b>ADB3746</b>	21837		
<b>Lite-Ace</b> 2.2 D (YR22)	F	01/92→	Akebono		255	<b>ADB3422</b>	20182		
<b>Lite-Ace</b> 2.2 D (YR29)	F	01/92→	Akebono		255	<b>ADB3746</b>	21837		
<b>Power Van (Hi-Ace 96→)</b> 2.0 except 4x4 4x4	F	01/96→	Sumitomo			<b>ADB0440</b>	21689		
	F	01/96→	Sumitomo			<b>ADB0459</b>	21468		

Where more than one part number is shown, use illustrations to determine correct pad fitment for the application

















# Application Data

## Brake Pads, Wear Leads and Fitting Kits

# ANL Braking

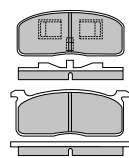
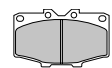
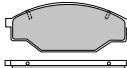
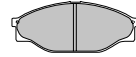
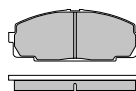
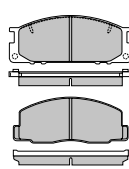
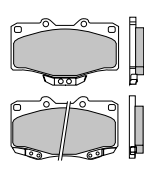
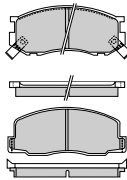
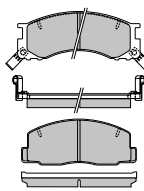
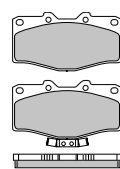
									
<b>TOYOTA – cont.</b> Power Van (Hi-Ace 96→) 2.4 except 4x4 4x4	F	01/96→	Sumitomo			<b>ADB0440</b>	21689		
	F	01/96→	Sumitomo			<b>ADB0459</b>	21468		
<b>PSV Caetano, Optimo, Optimo 2 Micro Bus</b>	F	01/86→							
	R	01/86→							
<b>T100</b> 500Kg Pick-Up	F	01/96→	Akebono						
<b>T100</b> 1 Ton Pick-Up	F	01/96→	Akebono						
<b>ADB0264</b>	<b>ADB0265</b>	<b>ADB0297</b>	<b>ADB0440</b>	<b>ADB0459</b>					
									
132.0 × 48.0 × 15	107.3 × 66.0 × 15	142.0 × 55.5 × 15	140.0 × 54.0 × 15.5	145.0 × 57.0 × 16					
<b>ADB0589</b>	<b>ADB3333</b>	<b>ADB3422</b>	<b>ADB3746</b>	<b>ADB31090</b>					
									
136.8 × 54.8 × 15.5	119.0 × 68.0 × 15	128.5 × 52.5 × 15.5	137.0 × 55.0 × 15.5	119.0 × 72.0 × 14.7					
<b>TRAILERS</b>									
<b>with Haldex brakes</b> 19.5" wheels	R	01/99→	Haldex			<b>ACV053</b>	29147		<b>K012</b>
<b>with Haldex brakes</b> 22.5" wheels	R	01/99→	Haldex			<b>ACV054</b>	29143		<b>K012</b>
<b>with Knorr brakes</b> SB 5000 17.5" wheels	R	01/98→	Knorr			<b>ACV038</b>	29115		<b>K005/ K018</b>
<b>with Knorr brakes</b> SB 6000 19.5" wheels	R	01/98→	Knorr			<b>ACV043</b>	29095	<b>WL015</b>	<b>K005/ K018</b>
Where more than one part number is shown, use illustrations to determine correct pad fitment for the application									













# Application Data

## Brake Pads, Wear Leads and Fitting Kits

# ANL

## Braking

											
<b>TRAILERS – cont.</b> with Knorr brakes SN 6000 19.5" wheels	R	06/03→						ACV061	29165		K005/ K018
	R	06/03→						ACV062	29171		K005/ K018
with Knorr brakes SB 7000 22.5" wheels	R	01/98→						ACV042	29059	WL009	K005/ K018
with Knorr brakes SN 7000 22.5" wheels	R	06/03→						ACV063	29167		K005/ K018
with Meritor brakes B Duco 17.5" wheels	R	01/98→						ACV050	29136		K010
with Meritor brakes C Duco 19.5" wheels	R	01/98→						ACV051	29137		K011
with Meritor brakes D Duco 22.5" wheels	R	01/99→						ACV055	29125		K013
with Meritor brakes DX175 Axle 17.5" wheels	R	06/00→						ACV056	29149		K014
with Meritor brakes DX195 Axle 19.5" wheels	R	01/99→						ACV047	29124		K007
with Meritor brakes DX225 Axle 22.5" wheels	R	06/00→						ACV057	29150		K007
with Meritor brakes D Elsa (D3) 22.5" wheels	R	01/98→						ACV014	29030		K002/ K016
with Meritor brakes D Elsa 2 22.5" wheels	R	06/00→						ACV058	29131		K002
with Meritor brakes C Lisa 19.5" wheels	R	06/00→						ACV033	29099		K004
with Meritor brakes D Lisa 22.5" wheels	R	06/00→						ACV029	29090		K003/ K017
with Wabco / Perrot brakes PAN 17 17.5" wheels	R	06/00→									

Where more than one part number is shown, use illustrations to determine correct pad fitment for the application



# Application Data

## Brake Pads, Wear Leads and Fitting Kits

# ANL Braking



<b>TRAILERS – cont.</b> with Wabco / Perrot brakes PAN 19-1 19.5" wheels	R	01/99→	Wabco / Perrot			<b>ACV048</b>	29126		
with Wabco / Perrot brakes PAN 22 22.5" wheels	R	01/99→	Wabco / Perrot			<b>ACV049</b>	29146		

<b>ACV014</b>	<b>ACV029</b>	<b>ACV033</b>	<b>ACV038</b>	<b>ACV042</b>
250.0 × 118.0 × 28	250.0 × 114.0 × 28	214 × 112 × 25	173.6 × 84 × 34.00/27.00	248.0 × 108.0 × 30

<b>ACV043</b>	<b>ACV047</b>	<b>ACV048</b>	<b>ACV049</b>	<b>ACV050</b>
210.7 × 92.5 × 30	205.5 × 100 × 27	210 × 93 × 30	247 × 107 × 30	176 × 88 × 30

<b>ACV051</b>	<b>ACV053</b>	<b>ACV054</b>	<b>ACV055</b>	<b>ACV056</b>
210 × 102 × 30	210.7 × 93.5 × 30	248 × 105 × 30	248 × 109 × 30	179.5 × 95 × 28

<b>ACV057</b>	<b>ACV058</b>	<b>ACV061</b>	<b>ACV062</b>	<b>ACV063</b>
245 × 120 × 30	250.0 × 118.0 × 30	210 × 92 × 29	210 × 108 × 29	247 × 110 × 29

**TRANSBUS INTERNATIONAL DENNIS**  
see DENNIS

Where more than one part number is shown, use illustrations to determine correct pad fitment for the application



# Application Data

## Brake Pads, Wear Leads and Fitting Kits

# ANL Braking

					ACV/ADB	WVA NO.	WL	K
					mm			
<b>VAN HOOL</b>								
PSV A 420, A 440	F		Knorr			ACV006	29747	K001
	R							
PSV Eos	F	01/98→	Knorr		406	ACV006	29747	K001
	F	01/98→	Knorr		410	ACV006	29747	K001
	R	01/98→						
PSV Renault chassis	F	01/97→	Meritor (Lucas)			ACV014 <sup>①</sup>	29030	WL001/ WL002 K002/ K016
	F	01/97→	Meritor (Lucas)			ACV030 <sup>②</sup>	29053	WL001/ WL002 K013/ K016
	F	01/97→	Meritor (Lucas)			ACV033	29100	WL010 K004
<b>Note: Disc Th 45→41mm use <sup>①</sup>, 41→38mm use <sup>②</sup></b>								
	<b>ACV006</b>	<b>ACV014</b>	<b>ACV030</b>	<b>ACV033</b>				
	140.0 × 121.0 × 32	250.0 × 118.0 × 28	250.0 × 118.0 × 28	214 × 112 × 25				
<b>VAUXHALL</b>								
Arena Van 2.5 Diesel	F	07/97-10/00	Bendix		252	ADB21048	20926	
Astra Van (→10/91) 1.3 →VIN FE299999 VIN GE100001→	F	01/82-01/86	Ate		236	ADB0135	20939	
	F	01/82-01/86	GM Delco		236	ADB0135	20939	
	F	01/86-10/91	Ate		236	ADB0135	20939	
	F	01/86-10/91	GM Delco		236	ADB0135	20939	
Astra Van (→10/91) 1.4	F	09/89-10/91	Ate		236	ADB0135	20939	
	F	09/89-10/91	GM Delco		236	ADB0135	20939	
Astra Van (→10/91) 1.6 Petrol	F	01/82-10/91	Ate		236	ADB0135	20939	
	F	01/85-10/91	GM Delco		236	ADB0135	20939	
	F	01/85-10/91	GM Delco		236	ADB0135	20939	
Astra Van (→10/91) 1.6 Diesel	F	01/82-01/89	Ate		236	ADB0135	20939	
	F	01/82-01/89	GM Delco		236	ADB0135	20939	
	F	01/85-01/89	GM Delco		236	ADB0135	20939	

Where more than one part number is shown, use illustrations to determine correct pad fitment for the application



# Application Data

## Brake Pads, Wear Leads and Fitting Kits

# ANL Braking

						ACV/ADB	WVA NO.	WL	K
						mm			
<b>VAUXHALL – cont.</b>									
Astra Van (→10/91) 1.7 Diesel	F	01/89–10/91	Ate		236	ADB0135	20939		
	F	01/89–10/91	GM Delco		236	ADB0135	20939		
	F	01/89–10/91	GM Delco		236	ADB0135	20939		
Astra Van (10/91→07/98) 1.4i	F	10/91–07/98	Ate		236	ADB0134	20547		
Astra Van (10/91→07/98) 1.6i	F	10/91–07/98	Ate		236	ADB0134	20547		
	F	10/91–07/98	Ate		236	ADB0134	20547		
Astra Van (10/91→07/98) 1.7D, TD	F	10/91–07/98	Ate		236	ADB0134	20547		
	F	10/91–07/98	Ate		256	ADB0134	20547		
Astra Van (7/98→) 1.2i non ABS ABS	F	07/98→	Ate		256	ADB3584	23063		
	F	07/98→	Ate		256	ADB3583	23116		
	R	07/98→	Bosch		240	ADB3750	23258		
Astra Van (7/98→) 1.4i 16V non ABS ABS	F	07/98→	Ate		256	ADB3584	23063		
	F	07/98→	Ate		256	ADB3583	23116		
	R	07/98→	Bosch		240	ADB3750	23258		
Astra Van (7/98→) 1.6i, 1.6i 16V non ABS ABS	F	07/98→	Ate		256	ADB3584	23063		
	F	07/98→	Ate		256	ADB3583	23116		
	R	07/98→	Bosch		240	ADB3750	23258		
Astra Van (7/98→) 1.7 Turbo Diesel non ABS ABS	F	07/98→	Ate		256	ADB3584	23063		
	F	07/98→	Ate		256	ADB3583	23116		
	R	07/98→	Bosch		240	ADB3750	23258		
Astra Van (7/98→) 2.0 Diesel non ABS ABS	F	07/98→	Ate		256	ADB3584	23063		
	F	07/98→	Ate		280	ADB3583	23116		
	R	07/98→	Bosch		240	ADB3750	23258		
	R	07/98→	Bosch		264	ADB3750	23258		
Astramax Van 1.3	F	01/85–10/89	Ate		236	ADB0135	20939		
	F	01/85–10/89	GM Delco		236	ADB0135	20939		
Astramax Van 1.4	F	09/89–10/91	Ate		236	ADB0135	20939		
	F	09/89–10/91	GM Delco		236	ADB0135	20939		
	F	10/91–07/98	Ate		236	ADB0134	20547		

Where more than one part number is shown, use illustrations to determine correct pad fitment for the application



# Application Data

## Brake Pads, Wear Leads and Fitting Kits

# ANL

## Braking

						ACV/ADB	WVA	WL	K
						mm	NO.		
<b>VAUXHALL – cont.</b>									
Astramax Van 1.6	F	01/85–10/91	GM Delco		236	<b>ADB0135</b>	20939		
	F	10/91–07/98	Ate		236	<b>ADB0134</b>	20547		
Astramax Van 1.6 Diesel	F	01/85–01/89	GM Delco		236	<b>ADB0135</b>	20939		
Astramax Van 1.7 Diesel, Turbo Diesel	F	10/91–07/98	Ate		236	<b>ADB0134</b>	20547		
	F	01/89–10/91	GM Delco		236	<b>ADB0135</b>	20939		
	F	10/91–07/98	Ate		256	<b>ADB0134</b>	20547		
Brava 2x4, 4x4 Pick-up	F	01/88→	Akebono		257	<b>ADB3322</b>	21544		
CF2 Van 250, 280	F	01/84–01/87	Lockheed		270	<b>ADB0239</b>	20364		
Chevanne	F	01/76–01/82	Ate		238	<b>ADB0731</b>	20034		
Corsa Van / Combo (→10/00) 1.4i, 1.7D, 1.7 TD	F	10/91–10/00	Ate		236	<b>ADB0134</b>	20547		
	F	10/91–10/00	Ate		236	<b>ADB0134</b>	20547		
	F	10/91–10/00	Ate		256	<b>ADB0134</b>	20547		
Corsa Van / Combo (10/00→) 1.2i 16V	F	10/00–06/02	Lucas		240	<b>ADB31112</b>	23225		
	F	06/02→	Lucas		240	<b>ADB31161</b>			
	F	10/00–06/02	Lucas		240	<b>ADB31112</b>	23225		
	F	06/02→	Lucas		240	<b>ADB31161</b>			
Corsa Van / Combo (10/00→) 1.7 TDi	F	10/00–06/02	Lucas		260	<b>ADB31112</b>	23225		
	F	06/02→	Lucas		260	<b>ADB31161</b>			
KB 26 Pick-Up 1.6, 2.0	F	01/80–01/84	Akebono		259				
	F	01/80–01/84	Akebono		259				
	F	01/84–01/88	Akebono		251		20881		
KB 41 Pick-Up 1.6, 2.0	F	01/84–01/88	Akebono		251		20881		
Midi Pick-Up, Van 1.8, 2.0 Petrol except 4x4	F	01/85–12/94	Sumitomo		251	<b>ADB0306</b>	21115		
Midi Pick-Up, Van 2.0, 2.2 Diesel except 4x4	F	01/85–12/94	Sumitomo		251	<b>ADB0306</b>	21115		
Movano 2.5 Diesel	F	03/98–10/00	Bendix		280	<b>ADB01021</b>	23302		
	F	10/00→	Bosch		280	<b>ADB01035</b>	23616		
	R	10/00→	Bosch		305	<b>ADB01036</b>	23669		
Movano 2.8 Turbo Diesel	F	03/98–10/00	Bendix		280	<b>ADB01021</b>	23302		
	F	10/00→	Bosch		280	<b>ADB01035</b>	23616		

–cont.











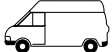















Where more than one part number is shown, use illustrations to determine correct pad fitment for the application

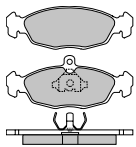
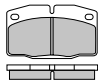

# Application Data

## Brake Pads, Wear Leads and Fitting Kits

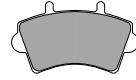
# ANL Braking

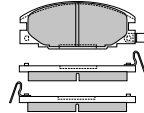
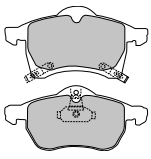
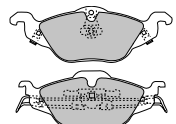
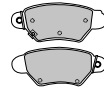
						 mm	 ACV/ADB	 WVA NO.	 WL	 K
<b>VAUXHALL – cont.</b> Movano – cont.			R	10/00→	Bosch	 305	<b>ADB01036</b>	23669		
Nova Van 1.2			F	01/90–01/94	Ate/Delco	 236	<b>ADB0135</b>	20939		
Nova Van 1.5			F	01/90–01/94	Ate/Delco	 236	<b>ADB0135</b>	20939		
Rascal Pick-Up & Van 1.0			F	01/86–01/93	Sumitomo	 215	<b>ADB0130</b>	20731		
Vivaro 1.9Di, 1.9TDi			F	09/00→	Lucas	 230	<b>ADB01127</b>	23099		
			R	09/00→	Lucas	 232	<b>ADB0874</b>	23224		
Vivaro 2.0i			F	09/00→	Lucas	 230	<b>ADB01127</b>	23099		
			R	09/00→	Lucas	 232	<b>ADB0874</b>	23224		
<b>ADB0130</b>	<b>ADB0134</b>	<b>ADB0135</b>	<b>ADB0239</b>	<b>ADB0306</b>						
										
119.3 × 37.7 × 15.5	141.3 × 48.5 × 16.5	99.9 × 59.0 × 15.4	88.5 × 70.9 × 15	133.0 × 47.2 × 16						
<b>ADB0731</b>	<b>ADB0874</b>	<b>ADB01021</b>	<b>ADB01035</b>	<b>ADB01036</b>						
										
61.7 × 56.5 × 14.5	95.0 × 57.5 × 17	139 × 68 × 18.7	138 × 80 × 17.8	116 × 51 × 16.8						
<b>ADB01127</b>	<b>ADB3322</b>	<b>ADB3583</b>	<b>ADB3584</b>	<b>ADB3750</b>						
										
145 × 62 × 18	127.0 × 50.8 × 16.5	156.5 × 79.5/72.0 × 19.6	177.8/160.2 × 62.5/63.0 × 17.70/16.70	105 × 43 × 16						

Where more than one part number is shown, use illustrations to determine correct pad fitment for the application



# Application Data

## Brake Pads, Wear Leads and Fitting Kits

# ANL

## Braking

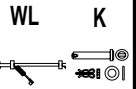

### VAUXHALL – cont.

ADB21048

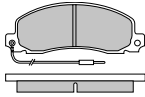

155.8 × 56.7 × 18.5

ADB31112

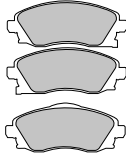

131.8 × 51.4 × 17.0

ADB31161

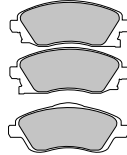

131.8 × 51.4 × 17.0

### VOLKSWAGEN

#### Caddy

1.6, 1.8

F

01/84–11/95

VW 2



239

ADB0149

20887

#### Caddy II

1.4i, 1.6i, 1.8i, 1.9 TDi

F

11/95–04/96

Lucas



256

ADB0511

20168

F

04/96→

Lucas



256

ADB0989

21945

F

04/96→

Lucas



256

ADB0928<sup>Ⓢ</sup>

20861

Note: <sup>Ⓢ</sup> Use illustrations to determine correct pad fitment

#### Golf I Van

1.1

F

01/80–01/83

Ate



239

ADB0101

20228

#### Golf II Van

1.3

F

01/83–01/92

VW 2



239

ADB0149

20887

#### Golf II Van

1.6 Diesel  
except Turbo  
Turbo

F

01/84–01/92

VW 2



239

ADB0149

20887

F

01/88–01/92

VW 2



239

ADB0149

20887

#### Golf Mk III Van

1.9 Diesel, 1.9 Turbo Diesel

F

01/92→

Lucas



256

ADB0511

20168

F

01/92–07/95

VW 2



239

ADB0149

20887

F

07/95→

Ate / VW 3



239

ADB0706

21866

F

01/92→

Lucas



256

ADB0152

20168

#### LT Series (→96)

28, 31

F

01/75–03/81

Ate



281

20280

F

03/81–01/96

Ate



281

20280

#### LT Series (→96)

35, 40, 45, 50, 55

F

01/75–03/81

Ate



281

20280

F

03/81–01/96

Ate



281

20280

#### LT Series (96→)

28

F

01/96→

Ate



276

ADB0212

21576

F

01/96→

Ate



276

ADB0212

21576

R

01/96→

Ate



258

ADB0453

21621

R

01/96→

Ate



272

ADB0453

21621

R

01/96→

Bosch



258

ADB0914

23021

R

01/96→

Bosch



272

ADB0914

23021

#### LT Series (96→)

35

F

01/96→

Ate



276

ADB0212

21576

F

01/96→

Ate



276

ADB0212

21576

–cont.

Where more than one part number is shown, use illustrations to determine correct pad fitment for the application





# Application Data

## Brake Pads, Wear Leads and Fitting Kits

# ANL

## Braking

						ACV/ADB	WVA NO.	WL	K
					mm				
<b>VOLKSWAGEN – cont.</b>									
LT Series (96→) – cont.									
	R	01/96→	Ate		258	<b>ADB0478</b>	21592		
	R	01/96→	Ate		272	<b>ADB0478</b>	21592		
	R	01/96→	Bosch		258	<b>ADB0914</b>	23021		
	R	01/96→	Bosch		272	<b>ADB0914</b>	23021		
LT Series (96→)									
46									
	F	01/00→	Bosch		276	<b>ADB0271</b>	29076		
	F	01/96→	Wabco / Perrot		276	<b>ADB0271</b>	29076		
	F	01/96→	Wabco / Perrot		276	<b>ADB0271</b>	29076		
	R	01/96→	Bosch		272	<b>ADB0271</b>	29076		
	R	01/00→	Bosch		285	<b>ADB0271</b>	29076		
	R	01/96→	Wabco / Perrot		258	<b>ADB0271</b>	29076		
	R	01/96→	Wabco / Perrot		272	<b>ADB0271</b>	29076		
	R	01/96→	Wabco / Perrot		285	<b>ADB0271</b>	29076		
Taro									
1.8, 2.5 Diesel									
2x4									
4x4									
	F	01/89–07/96	Akebono		257	<b>ADB0297</b>	21158		
	F	01/89–07/96	Sumitomo		257	<b>ADB3333</b>	21680		
Transporter Van (T2)									
1.6									
	F	08/70–01/72	Ate		278	<b>ADB0128</b>	20011		
	F	01/72–01/79	Ate		278	<b>ADB0247</b>	20011		
	F	01/79–01/86	Ate		278	<b>ADB0247</b>	20011		
	F	01/86–01/90	Lucas		258	<b>ADB0124</b>	20979		
Transporter Van (T2)									
1.7									
	F	01/87–01/90	Lucas		258	<b>ADB0124</b>	20979		
Transporter Van (T2)									
1.9									
	F	01/82–01/86	Ate		278	<b>ADB0247</b>	20011		
	F	07/86–01/90	Lucas		258	<b>ADB0124</b>	20979		
Transporter Van (T2)									
2.0									
	F	01/72–01/86	Ate		278	<b>ADB0247</b>	20011		
Transporter Van (T2)									
2.1									
except Syncro									
non ABS									
ABS									
Syncro									
14" wheels									
15" wheels									
16" wheels									
	F	01/79–01/86	Ate		278	<b>ADB0247</b>	20011		
	F	07/86–01/90	Lucas		258	<b>ADB0124</b>	20979		
	F	07/86–01/90	Lucas		258	<b>ADB0124</b>	20979		
	F	07/86–01/90	Lucas		258	<b>ADB0124</b>	20979		
	F	07/86–01/90	Lucas		277	<b>ADB0124</b>	20979		
	F	07/86–01/90	Lucas		280	<b>ADB0124</b>	20979		
Transporter Van (T4)									
1.9D									
14" wheels									
15" wheels									
	F	01/90–05/96	Lucas		260	<b>ADB01073</b>	20124		
	F	01/90–05/96	Lucas		282	<b>ADB0419</b>	21479		
	F	01/90–05/96	Lucas		282	<b>ADB1419</b>	21479		
	F	01/90–05/96	Ate		280	<b>ADB0925</b>	20652		
	R	01/90–05/96	Lucas			<b>ADB0272</b>	21882		

Where more than one part number is shown, use illustrations to determine correct pad fitment for the application



# Application Data

## Brake Pads, Wear Leads and Fitting Kits

# ANL Braking

 	 	 	 	 	 mm	 ACV/ADB	 WVA NO.	 WL	 K
<b>VOLKSWAGEN – cont.</b> Transporter Van (T4) 2.0 14" wheels 15" wheels	F	01/90–05/96	Lucas		260	<b>ADB01073</b>	20124		
	F	01/90–05/96	Lucas		282	<b>ADB0419</b>	21479		
	F	01/90–05/96	Lucas		282	<b>ADB1419</b>	21479		
	F	01/90–05/96	Ate		280	<b>ADB0925</b>	20652		
	R	01/90–05/96	Lucas			<b>ADB0272</b>	21882		
Transporter Van (T4) 2.4 14" wheels 15" wheels	F	01/90–05/96	Lucas		260	<b>ADB01073</b>	20124		
	F	01/90–05/96	Lucas		282	<b>ADB0419</b>	21479		
	F	01/90–05/96	Lucas		282	<b>ADB1419</b>	21479		
	F	01/90–05/96	Ate		280	<b>ADB0925</b>	20652		
	R	01/90–05/96	Lucas			<b>ADB0272</b>	21882		
Transporter Van (T4) 2.5 14" wheels 15" wheels	F	01/90–05/96	Lucas		260	<b>ADB01073</b>	20124		
	F	01/90–05/96	Lucas		282	<b>ADB0419</b>	21479		
	F	01/90–05/96	Lucas		282	<b>ADB1419</b>	21479		
	F	01/90–05/96	Ate		280	<b>ADB0925</b>	20652		
	R	01/90–05/96	Lucas			<b>ADB0272</b>	21882		
Transporter Van (T4) 2.5D 14" wheels 15" wheels	F	01/90–05/96	Lucas		260	<b>ADB01073</b>	20124		
	F	01/90–05/96	Lucas		282	<b>ADB0419</b>	21479		
	F	01/90–05/96	Lucas		282	<b>ADB1419</b>	21479		
	F	01/90–05/96	Ate		280	<b>ADB0925</b>	20652		
	R	01/90–05/96	Lucas		280	<b>ADB0272</b>	21882		
Transporter Van (T4 96→) 1.9D, 1.9TDi  15" wheels  16" wheels	F	05/96→	Lucas		282	<b>ADB0419</b>	21479		
	F	05/96→	Lucas		282	<b>ADB1419</b>	21479		
	R	05/96–03/98	Lucas		280	<b>ADB0272</b>	21882		
	R	05/96–03/98	Lucas		280	<b>ADB1907</b>			
	R	03/98→	Lucas		280	<b>ADB0874</b>	23224		
	R	03/98→	Lucas		280	<b>ADB1874</b>	23224		
	R	03/98→	Lucas		294	<b>ADB11151</b>	23446		
Transporter Van (T4 96→) 2.0  15" wheels  16" wheels	F	05/96→	Lucas		282	<b>ADB0419</b>	21479		
	F	05/96→	Lucas		282	<b>ADB1419</b>	21479		
	R	05/96–03/98	Lucas		280	<b>ADB0272</b>	21882		
	R	05/96–03/98	Lucas		280	<b>ADB1907</b>			
	R	03/98→	Lucas		280	<b>ADB0874</b>	23224		
	R	03/98→	Lucas		280	<b>ADB1874</b>	23224		
	R	03/98→	Lucas		294	<b>ADB11151</b>	23446		
Transporter Van (T4 96→) 2.4 D	F	05/96→	Lucas		282	<b>ADB0419</b>	21479		
	F	05/96→	Lucas		282	<b>ADB1419</b>	21479		
	F	05/96→	Lucas		280	<b>ADB0953</b>	21634		
	F	05/96→	Lucas		280	<b>ADB1953</b>	23176		

-cont.

Where more than one part number is shown, use illustrations to determine correct pad fitment for the application



# Application Data

## Brake Pads, Wear Leads and Fitting Kits

# ANL

## Braking

<b>VOLKSWAGEN – cont.</b>								
<b>Transporter Van (T4 96→) – cont.</b>								
15" wheels	R	05/96–03/98	Lucas		280	<b>ADB0272</b>	21882	
	R	05/96–03/98	Lucas		280	<b>ADB1907</b>		
	R	03/98→	Lucas		280	<b>ADB0874</b>	23224	
16" wheels	R	03/98→	Lucas		280	<b>ADB1874</b>	23224	
	R	03/98→	Lucas		294	<b>ADB11151</b>	23446	
<b>Transporter Van (T4 96→)</b>								
<b>2.5i</b>								
	F	05/96→	Lucas		280	<b>ADB0953</b>	21634	
	F	05/96→	Lucas		280	<b>ADB1953</b>	23176	
15" wheels	R	05/96–03/98	Lucas		280	<b>ADB0272</b>	21882	
	R	05/96–03/98	Lucas		280	<b>ADB1907</b>		
	R	03/98→	Lucas		280	<b>ADB0874</b>	23224	
16" wheels	R	03/98→	Lucas		280	<b>ADB1874</b>	23224	
	R	03/98→	Lucas		294	<b>ADB11151</b>	23446	
<b>Transporter Van (T4 96→)</b>								
<b>2.5 TDi</b>								
	F	05/96→	Ate		280	<b>ADB0186</b>	21883	
	F	05/96→	Ate		280	<b>ADB1852</b>	21885	
	F	05/98→	Ate		300	<b>ADB11168</b>	23034	
15" wheels	R	05/96–03/98	Lucas		280	<b>ADB0272</b>	21882	
	R	05/96–03/98	Lucas		280	<b>ADB1907</b>		
	R	03/98→	Lucas		280	<b>ADB0874</b>	23224	
16" wheels	R	03/98→	Lucas		280	<b>ADB1874</b>	23224	
	R	03/98→	Lucas		294	<b>ADB11151</b>	23446	
<b>Transporter Van (T4 96→)</b>								
<b>2.8 VR6</b>								
	F	05/96→	Ate		280	<b>ADB0186</b>	21883	
	F	05/96→	Ate		280	<b>ADB1852</b>	21885	
	F	05/98→	Ate		300	<b>ADB11168</b>	23034	
15" wheels	R	05/96–03/98	Lucas		280	<b>ADB0272</b>	21882	
	R	05/96–03/98	Lucas		280	<b>ADB1907</b>		
	R	03/98→	Lucas		280	<b>ADB0874</b>	23224	
16" wheels	R	03/98→	Lucas		280	<b>ADB1874</b>	23224	
	R	03/98→	Lucas		294	<b>ADB11151</b>	23446	
<b>ADB0101</b>	<b>ADB0124</b>	<b>ADB0128</b>	<b>ADB0149</b>	<b>ADB0152</b>				
61.7 × 56.5 × 15	129.9 × 59.0 × 19.5	76.7 × 70.2 × 15	137.7 × 50.0 × 19.5	119.0 × 69.0 × 16				
Where more than one part number is shown, use illustrations to determine correct pad fitment for the application								



# Application Data

## Brake Pads, Wear Leads and Fitting Kits

# ANL

## Braking



WL

K

### VOLKSWAGEN – cont.

**ADB0186**

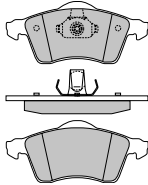

156.4 × 68.5 × 20

**ADB0212**

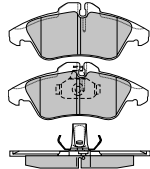

156.5 × 64.8 × 19.30

**ADB0247**



76.7 × 70.2 × 18.5

**ADB0271**

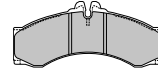

165.0 × 73.0 × 19.5

**ADB0272**

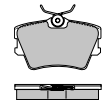

95.0 × 57.5 × 17

**ADB0297**

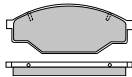

142.0 × 55.5 × 15

**ADB0419**

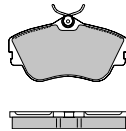

130.0 × 69.0 × 18.3

**ADB0453**

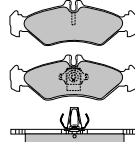

141.0 × 49.0 × 16.6

**ADB0478**

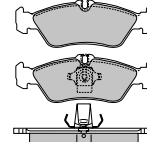

156.0 × 55.0 × 18

**ADB0511**

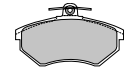

119.0 × 69.0 × 19.3

**ADB0706**

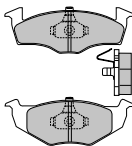

141.8 × 51.2 × 19

**ADB0874**



95.0 × 57.5 × 17

**ADB0914**

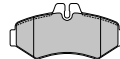

126 × 63 × 17.8

**ADB0925**



91.4 × 80.0 × 18

**ADB0928**

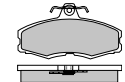

114.9 × 60.5 × 17.5

**ADB0953**

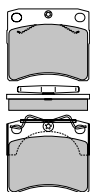

91.6 × 80 × 18

**ADB0989**

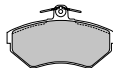

119.0 × 69.0 × 16

**ADB01073**

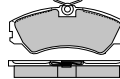

129.0 × 52.5 × 18

**ADB1419**

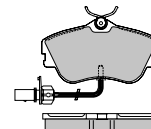

130.0 × 69.0 × 18.3

**ADB1852**

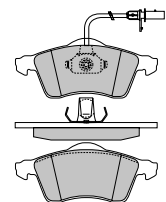

156.4 × 68.5 × 20

**ADB1874**

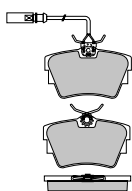

95.0 × 57.5 × 17

**ADB1907**

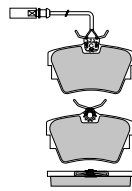

95 × 57.5 × 17

**ADB1953**

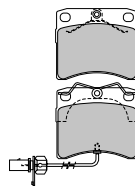

91.6 × 80 × 18

**ADB3333**

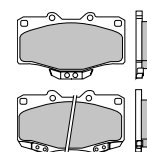

119.0 × 68.0 × 15

**ADB11151**

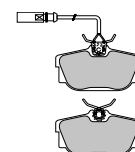

94.8 × 51 × 16.5

Where more than one part number is shown, use illustrations to determine correct pad fitment for the application



# Application Data

## Brake Pads, Wear Leads and Fitting Kits

# ANL

## Braking

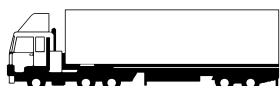

mm



ACV/ADB

WVA  
NO.

WL

K

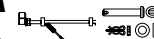

### VOLKSWAGEN – cont.

ADB11168

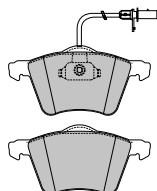

156.4 × 78.7 × 19

### VOLVO

#### FH Series

22.5" wheels  
D Duco

F	05/00→	Meritor (Lucas)			ACV055	29125		K013
R	05/00→	Meritor (Lucas)			ACV055	29125		K013

#### FL Series →05/00

FL4.06 → FL4.11

F	01/85–01/91	Meritor (Lucas)		322	ACV004 <sup>①</sup>	29302		
R	01/85–01/91	Meritor (Lucas)		322	ACV004 <sup>①</sup>	29302		

Note: <sup>①</sup> Replaced by ACV032, see Technical Bulletin #001

#### FL Series →05/00

FL4.06 → FL4.11

F	01/91–05/00	Meritor (Lucas)		322	ACV010 <sup>①</sup>	29039	WL021	
R	01/91–05/00	Meritor (Lucas)		322	ACV010 <sup>①</sup>	29039	WL021	

Note: <sup>①</sup> Replaced by ACV032, see Technical Bulletin #001

#### FL Series →05/00

FL6.07 → FL6.11

F	01/88–01/91	Meritor (Lucas)		322	ACV004 <sup>①</sup>	29302		
F	01/91–05/00	Meritor (Lucas)		322	ACV010 <sup>①</sup>	29039	WL021	
R	01/88–01/91	Meritor (Lucas)		322	ACV004 <sup>①</sup>	29302		
R	01/91–05/00	Meritor (Lucas)		322	ACV010 <sup>①</sup>	29039	WL021	

Note: <sup>①</sup> Replaced by ACV032, see Technical Bulletin #001

#### FL Series →05/00

FL6.12, FL6.13, FL6.14, FL6.15

F	01/88–01/91	Meritor (Lucas)		322	ACV004 <sup>①</sup>	29302		
F	01/91–05/00	Meritor (Lucas)		322	ACV010 <sup>①</sup>	29039	WL021	
R	01/88–01/91	Meritor (Lucas)		322	ACV004 <sup>①</sup>	29302		
R	01/91–05/00	Meritor (Lucas)		322	ACV010 <sup>①</sup>	29039	WL021	

Note: <sup>①</sup> Replaced by ACV032, see Technical Bulletin #001

#### FL Series →05/00

FL6.18, FL6.19

Note: <sup>①</sup> Replaced by ACV032, see Technical Bulletin #001

F	01/93–05/00	Meritor (Lucas)			ACV010 <sup>①</sup>	29039	WL021	
---	-------------	-----------------	--	--	---------------------	-------	-------	--

#### FL Series 05/00→

FL6.12  
17.5" wheels  
B Duco

F	05/00→	Meritor (Lucas)			ACV050	29136		K010
R	05/00→	Meritor (Lucas)			ACV050	29136		K010











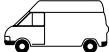







Where more than one part number is shown, use illustrations to determine correct pad fitment for the application



# Application Data

## Brake Pads, Wear Leads and Fitting Kits

# ANL Braking

					ACV/ADB	WVA NO.	WL	K
      								
<b>VOLVO – cont.</b> FL Series 05/00→ FL6.14, FL6.15 19.5" wheels C Duco	F	05/00→	Meritor (Lucas)		ACV051	29137		K011
	R	05/00→	Meritor (Lucas)		ACV051	29137		K011
<b>FL Series 05/00→</b> FL6.17, FL6.18 22.5" wheels D Duco	F	05/00→	Meritor (Lucas)		ACV055	29125		K013
	R	05/00→	Meritor (Lucas)		ACV055	29125		K013
<b>FLC</b> FL4.06 → FL4.11  <b>Note:</b> ① Replaced by ACV032, see Technical Bulletin #001	F	12/97→	Meritor (Lucas)		322 ACV010 <sup>①</sup>	29039	WL021	
	R	12/97→	Meritor (Lucas)		322 ACV010 <sup>①</sup>	29039	WL021	
<b>FM Series</b> 22.5" wheels D Duco	F	05/00→	Meritor (Lucas)		ACV055	29125		K013
	R	05/00→	Meritor (Lucas)		ACV055	29125		K013
<b>FS Series</b> FS7.16, FS7.17 <b>Note:</b> ① Replaced by ACV032, see Technical Bulletin #001	F	10/91→	Meritor (Lucas)		ACV010 <sup>①</sup>	29039	WL021	
<b>FS Series</b> FS7.18, FS7.19 <b>Note:</b> ① Replaced by ACV032, see Technical Bulletin #001	F	10/91→	Meritor (Lucas)		ACV010 <sup>①</sup>	29039	WL021	
<b>PSV B10L, B12L</b>	F	01/95→	Meritor (Lucas)		438 ACV029	29090	WL001	K003/ K017
<b>PSV with D Duco brakes</b>	F	01/99→	Meritor (Lucas)		434 ACV055	29125		K013

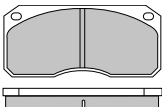
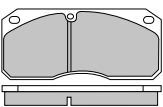
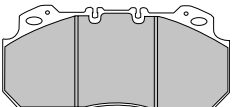
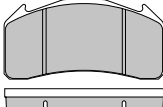
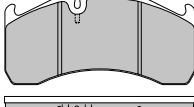
ACV004	ACV010	ACV029	ACV050	ACV051
Replaced by <b>ACV032</b>	Replaced by <b>ACV032</b>			
				
177 × 77.0 × 22	176 × 78 × 22	250.0 × 114.0 × 28	176 × 88 × 30	210 × 102 × 30

Where more than one part number is shown, use illustrations to determine correct pad fitment for the application



# Application Data

## Brake Pads, Wear Leads and Fitting Kits

# ANL Braking



mm



ACV/ADB

WVA  
NO.

WL

K

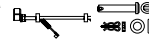

### VOLVO – cont.

ACV055

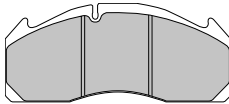

248 × 109 × 30

### WABCO BRAKES (includes Perrot)

PAN 17

17.5" wheels

R

PAN 19-1

19.5" wheels

R

01/99→

Wabco / Perrot



377

ACV048

29126

PAN 22

22.5" wheels

R

01/99→

Wabco / Perrot



430

ACV049

29146

ACV048

ACV049



210 × 93 × 30

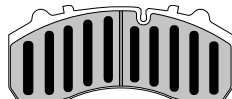

247 × 107 × 30

### YORK

Trailers

with Knorr SB 7000 brakes

01/98→

Knorr



ACV042

29108

K005/  
K018

ACV042

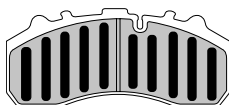

248.0 × 108.0 × 30





















Where more than one part number is shown, use illustrations to determine correct pad fitment for the application

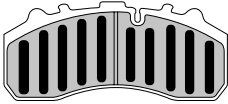
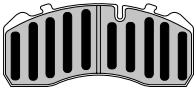
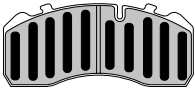

# Application Data

## Brake Pads, Wear Leads and Fitting Kits

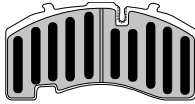
# ANL Braking

						 mm	 ACV/ADB	 WVA NO.	 WL	 K
<b>ZF AXLES</b>										
with Knorr brakes SB 6000 19.5" wheels				01/98→	Knorr	 370	ACV043 <sup>①</sup>	29095	WL015	K005/ K018
				01/98→	Knorr	 370	ACV044 <sup>②</sup>	29095	WL015	K005/ K018
Note: Disc Th 45→41mm use <sup>①</sup> , 41→38mm use <sup>②</sup>										
with Knorr brakes SN 6000 19.5" wheels				06/03→	Knorr	 370	ACV061	29165		K005/ K018
				06/03→	Knorr	 370	ACV062	29171		K005/ K018
with Knorr brakes SB 7000 22.5" wheels				01/98→	Knorr	 430	ACV042	29108		K005/ K018
with Knorr brakes SN 7000 22.5" wheels				06/03→	Knorr	 430	ACV063	29167		K005/ K018
<div style="display: flex; justify-content: space-around;"> <div style="text-align: center;"> <p>ACV042</p>  <p>248.0 × 108.0 × 30</p> </div> <div style="text-align: center;"> <p>ACV043</p>  <p>210.7 × 92.5 × 30</p> </div> <div style="text-align: center;"> <p>ACV044</p>  <p>210.7 × 92.5 × 30</p> </div> <div style="text-align: center;"> <p>ACV061</p>  <p>210 × 92 × 29</p> </div> <div style="text-align: center;"> <p>ACV062</p>  <p>210 × 108 × 29</p> </div> </div>										
<p><b>ACV063</b></p>  <p>247 × 110 × 29</p>										
Where more than one part number is shown, use illustrations to determine correct pad fitment for the application										





## Pad Illustrations

---

SECTION

C

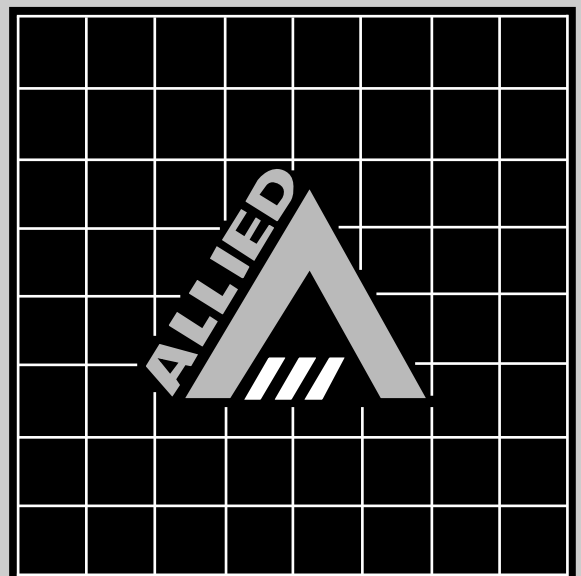



# Disc Brake Pads Illustrations

**ANL  
Braking**

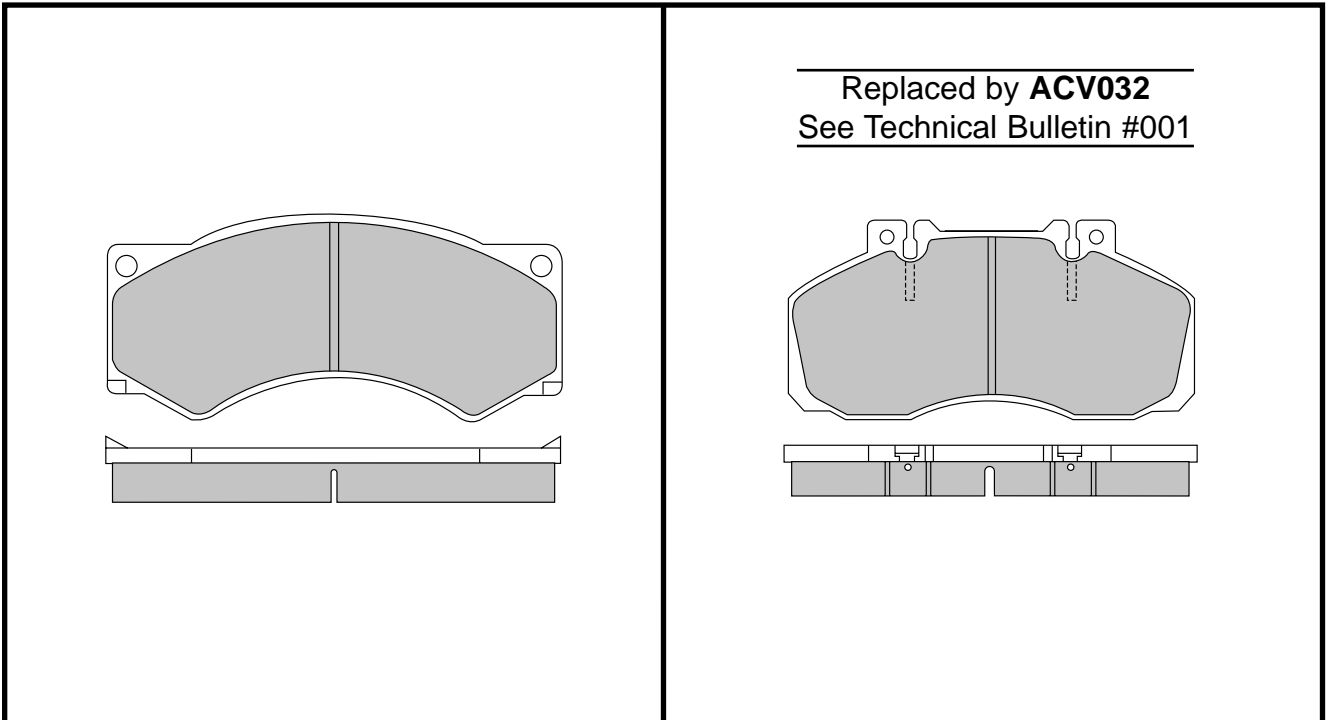

<b>ACV001</b>	DAEWOO DAF IVECO
 191.0    87.0    23	
<b>WVA: 29017</b>	

<b>ACV002</b>	AUWARTER MERCEDES OPTARE
 173.0    83.0    21.5	
<b>WVA: 29835</b>	

Remarks: 4 identical pads

Remarks: 4 identical pads

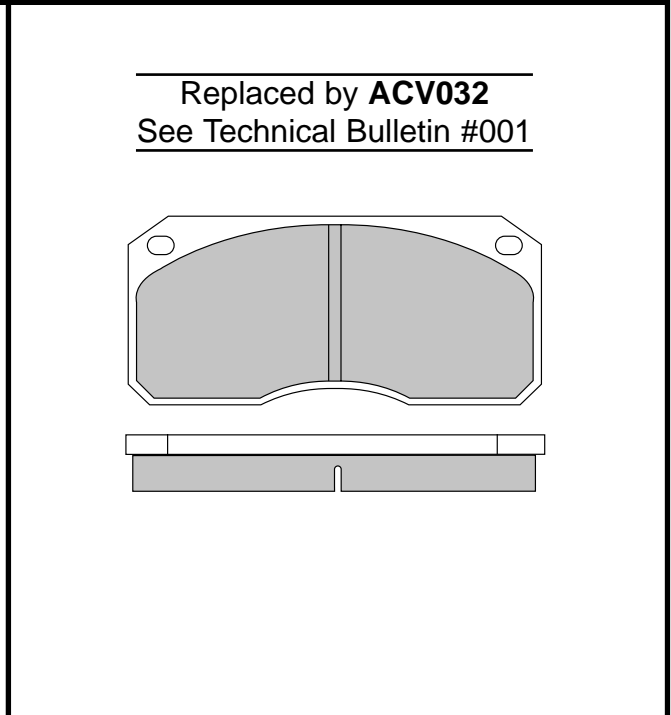
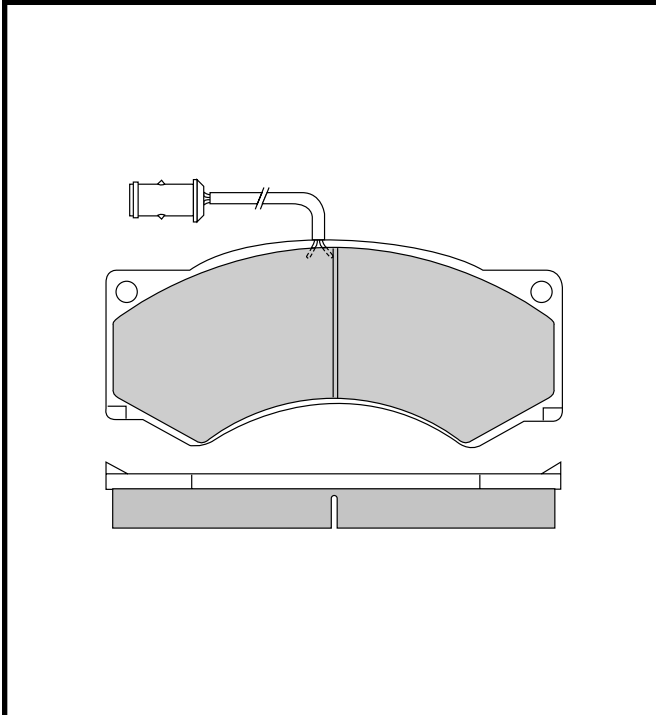

<b>ACV003</b>	DAEWOO DAF IVECO
 191.0    87.0    23	
<b>WVA: 29024</b>	

<b>ACV004</b>	AWD IVECO NISSAN OPTARE VOLVO
 177    77.0    22	
<b>WVA: 29302</b>	

Remarks: 2 plain pads, 2 pads with wear indicators

Remarks: 4 identical pads



# Disc Brake Pads Illustrations

## ANL Braking

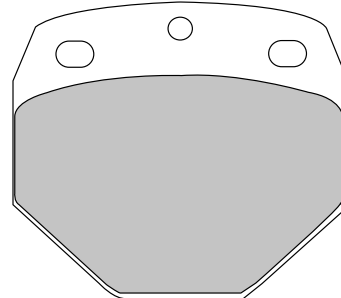
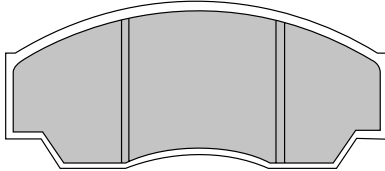

<b>ACV005</b>
WVA: 29036

<b>RENAULT</b>
----------------

<b>ACV006</b>
WVA: 29747

<b>AUWARTER, DAF KASSBOHRER KNORR - BREMSEN MAN MOSELEY / BOVA VAN HOOL</b>
---

Remarks: 4 identical pads

Remarks: 4 identical pads

Replaced by **ACV032**  
See Technical Bulletin #001

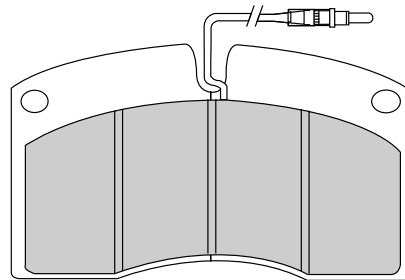
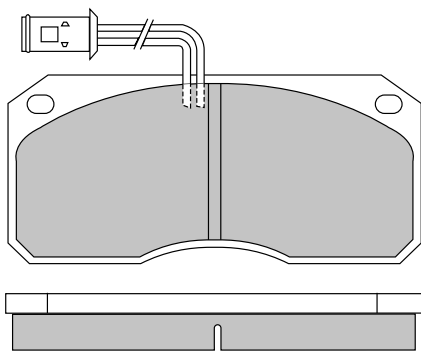

<b>ACV007</b>
WVA: 29033

<b>AWD IVECO NISSAN OPTARE</b>
--

<b>ACV008</b>
WVA: 29072

<b>MENARINI RENAULT</b>
-----------------------------

Remarks: 2 plain pads, 2 pads with wear indicators (490mm)

Remarks: 8 identical pads



# Disc Brake Pads Illustrations

**ANL  
Braking**

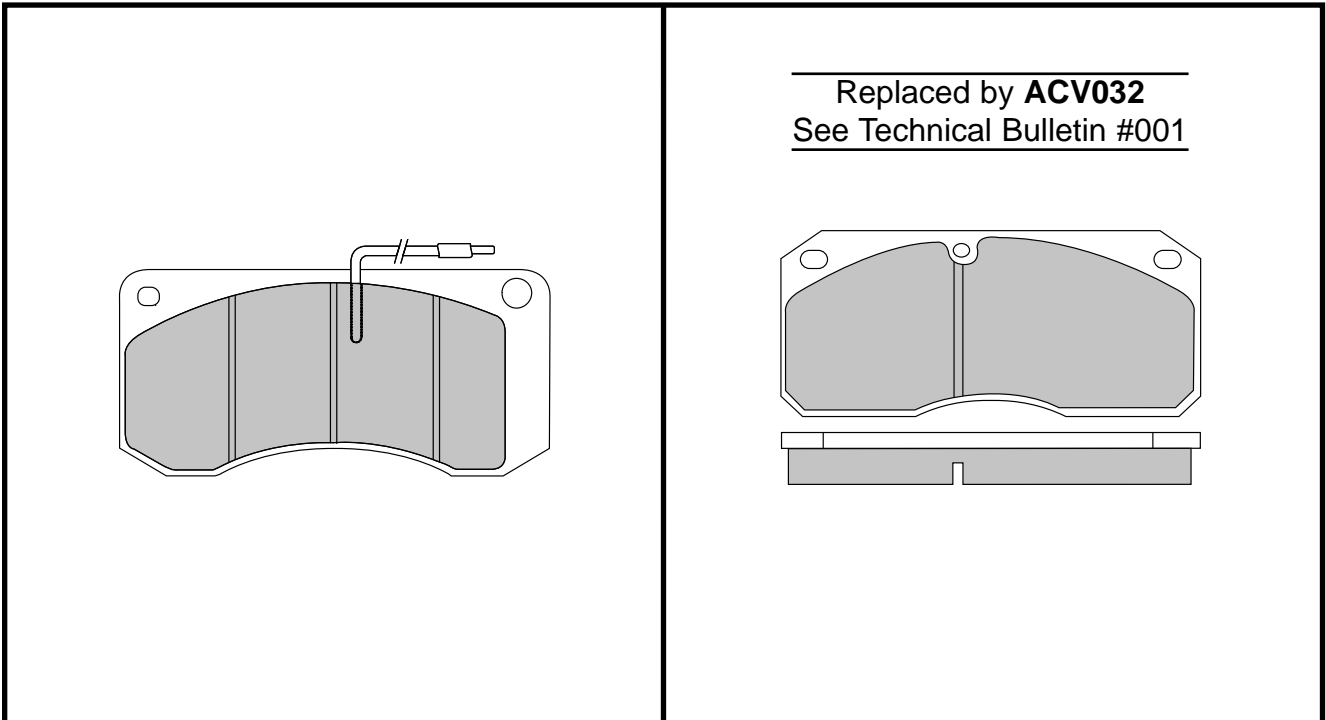

Replaced by **ACV032**  
See Technical Bulletin #001

<b>ACV009</b>
180.0    86.0    21.5
<b>WVA: 29013</b>

<b>DENNIS RENAULT</b>
---------------------------

<b>ACV010</b>
176    78    22
<b>WVA: 29039</b>

<b>NISSAN VOLVO</b>
-------------------------

Remarks: 2 pairs of pads with wear indicators      Remarks: 4 identical pads

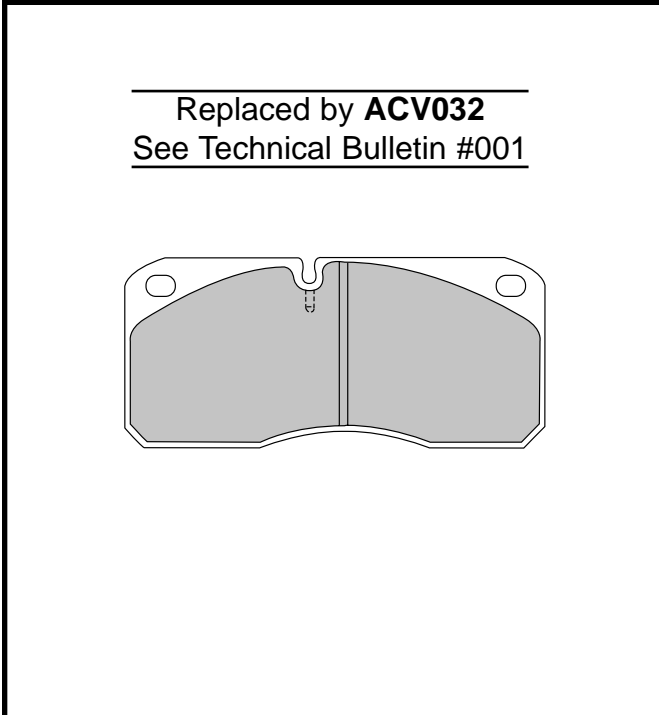

Replaced by **ACV032**  
See Technical Bulletin #001

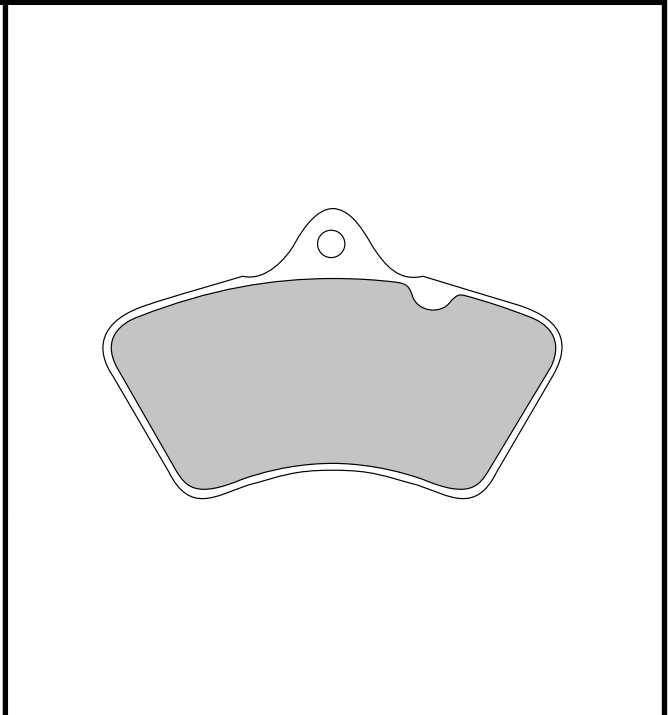

<b>ACV011</b>
175.0    77.0    22
<b>WVA: 21302</b>

<b>IVECO RENAULT</b>
--------------------------

<b>ACV012</b>
192    114    20
<b>WVA: 29498</b>

<b>KASSBOHRER KNORR - BREMSEN</b>
---------------------------------------

Remarks: 4 identical pads      Remarks: 4 identical pads



# Disc Brake Pads Illustrations

**ANL  
Braking**

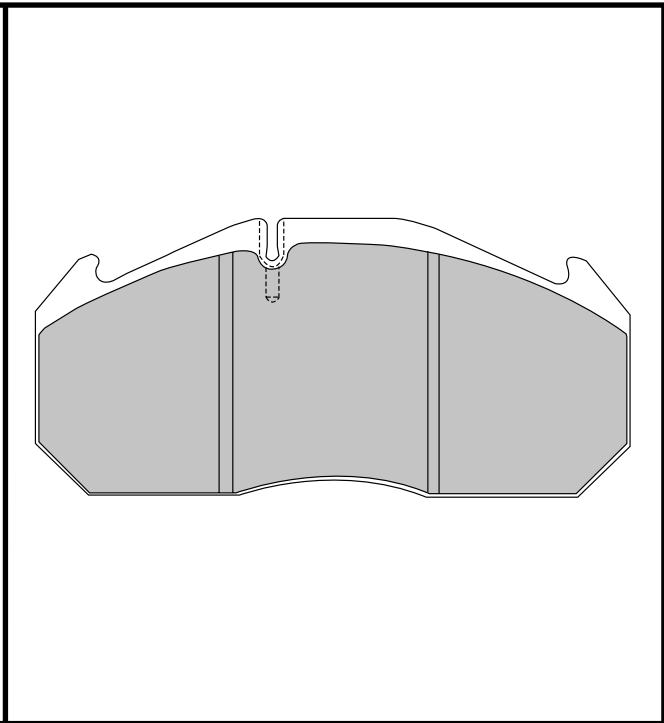
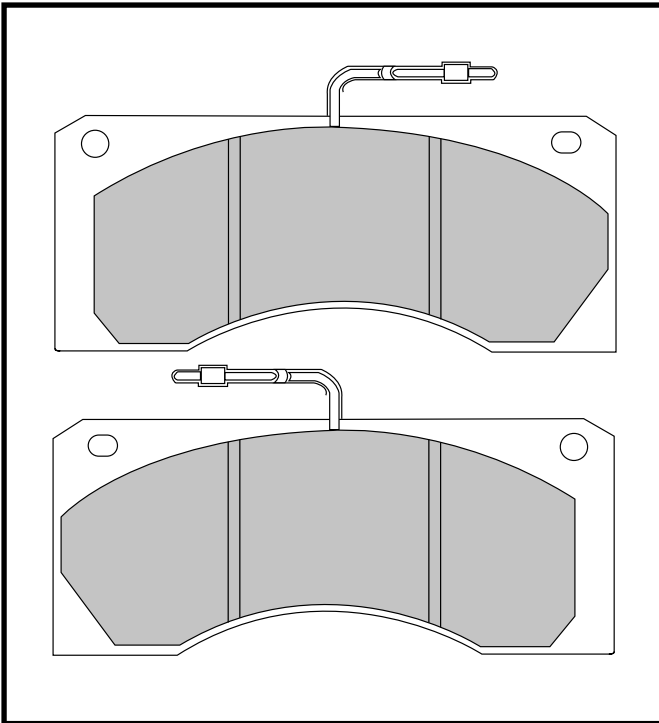

<b>ACV013</b>	<b>RENAULT</b>
 236.0    95.0    20	
<b>WVA: 29044</b>	

<b>ACV014</b>	<b>AUWARTER, DENNIS ERF, HEULIEZ KAROSA, KASSBOHRER MAN, MERCEDES MERITOR, RENAULT TRAILERS, VAN HOOL</b>
 250.0    118.0    28	
<b>WVA: 29030</b>	

Remarks: 2 pairs of pads with wear indicators

Remarks: 4 identical pads

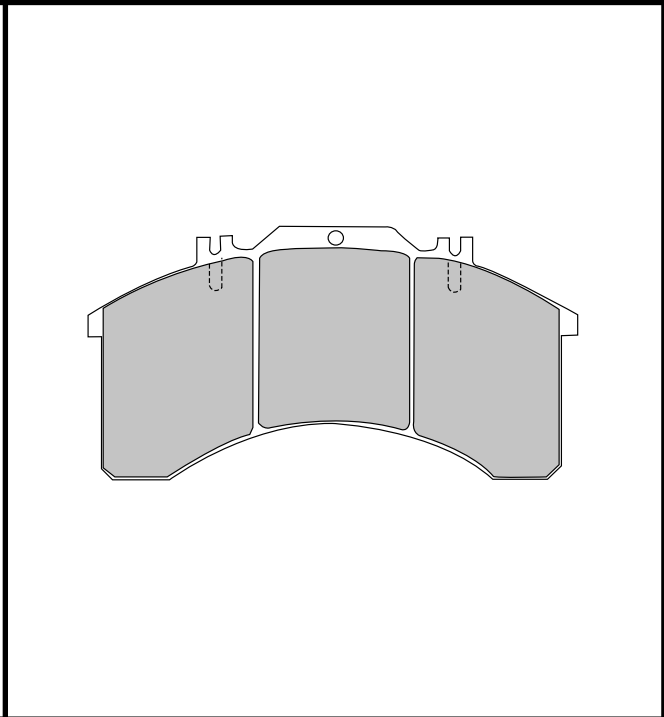
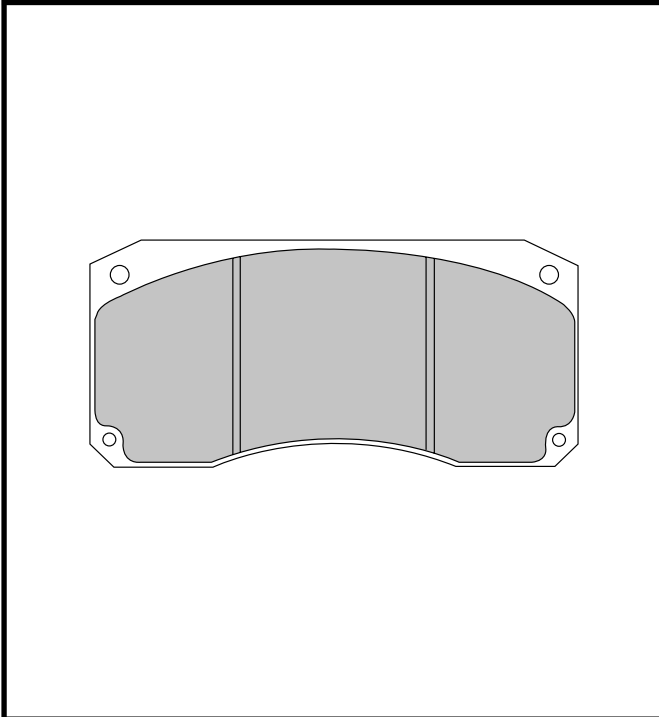

<b>ACV015</b>	<b>DENNIS RENAULT</b>
 204.0    96.0    24	
<b>WVA: 29043</b>	

<b>ACV016</b>	<b>IVECO</b>
 206.0    107.0    25	
<b>WVA: 29032</b>	

Remarks: 4 identical pads

Remarks: 4 identical pads



# Disc Brake Pads Illustrations

**ANL  
Braking**

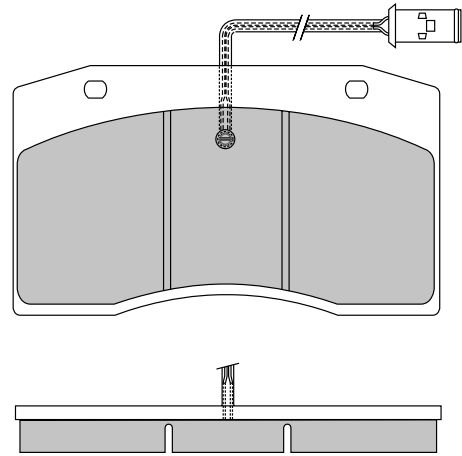
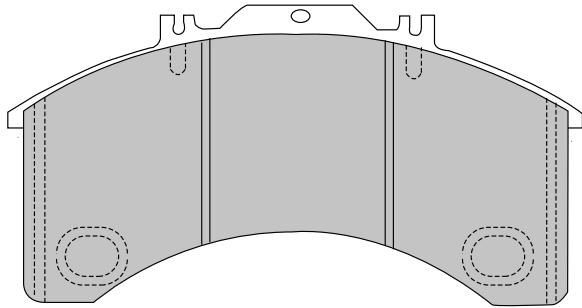

<b>ACV017</b>	<b>IVECO</b>
<b>WVA: 29011</b>	

<b>ACV018</b>	<b>IVECO</b>
<b>WVA: 29075</b>	

Remarks: 4 identical pads

Remarks: 6 plain pads, 2 pads with wear indicators

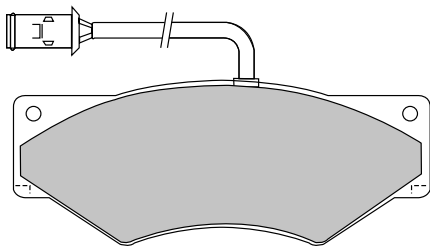

Replaced by **ACV032**  
See Technical Bulletin #001

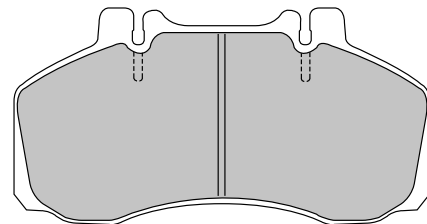

<b>ACV020</b>	<b>IVECO</b>
<b>WVA: 29001</b>	

<b>ACV021</b>	<b>IVECO RENAULT</b>
<b>WVA: 29065</b>	

Remarks: 2 plain pads, 2 pads with wear indicators

Remarks: 4 identical pads



# Disc Brake Pads Illustrations

**ANL  
Braking**

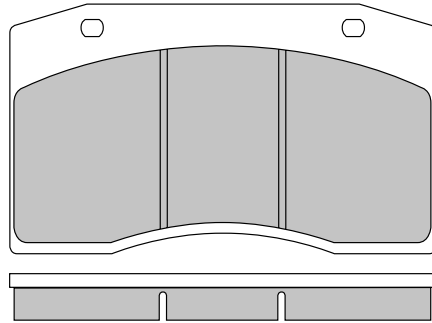
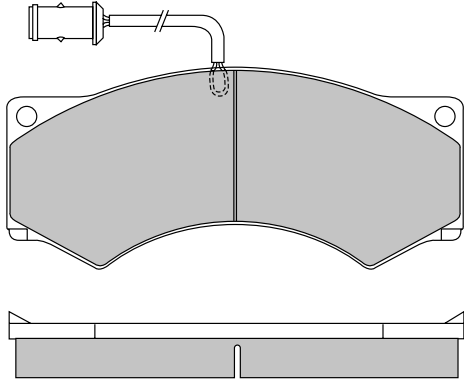

<b>ACV022</b>	<b>IVECO</b>
<b>WVA: 29017</b>	

<b>ACV023</b>	<b>IVECO</b>
<b>WVA: 29074</b>	

Remarks: 2 plain pads, 2 pads with wear indicators

Remarks: 8 identical pads

Replaced by **ACV032**  
See Technical Bulletin #001

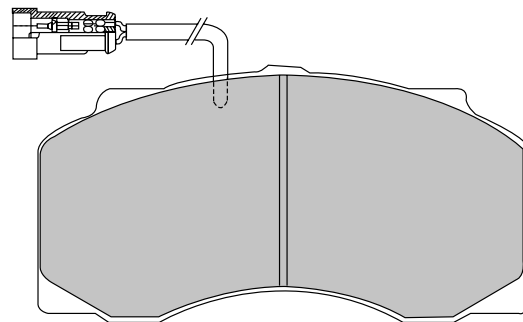
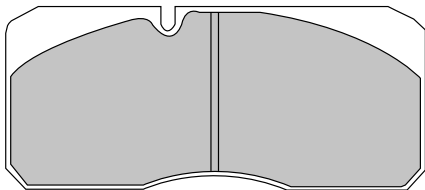

<b>ACV025</b>	<b>AUWARTER MAN</b>
<b>WVA: 29055</b>	

<b>ACV027</b>	<b>DAF</b>
<b>WVA: 29077</b>	

Remarks: 4 identical pads

Remarks: 2 plain pads, 2 pads with wear indicators



# Disc Brake Pads Illustrations

**ANL  
Braking**

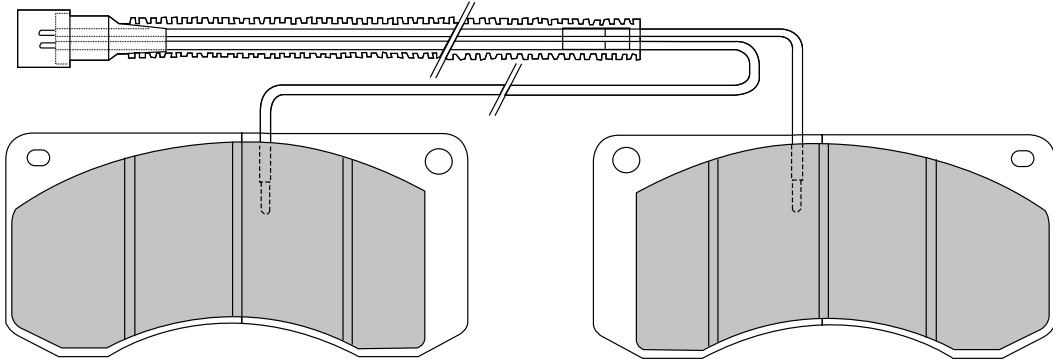

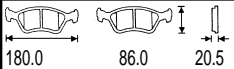
<b>ACV028</b>	<b>RENAULT</b>
	
<b>WVA: 29097</b>	

Remarks: 2 pairs of pads, each joined with a wear indicator

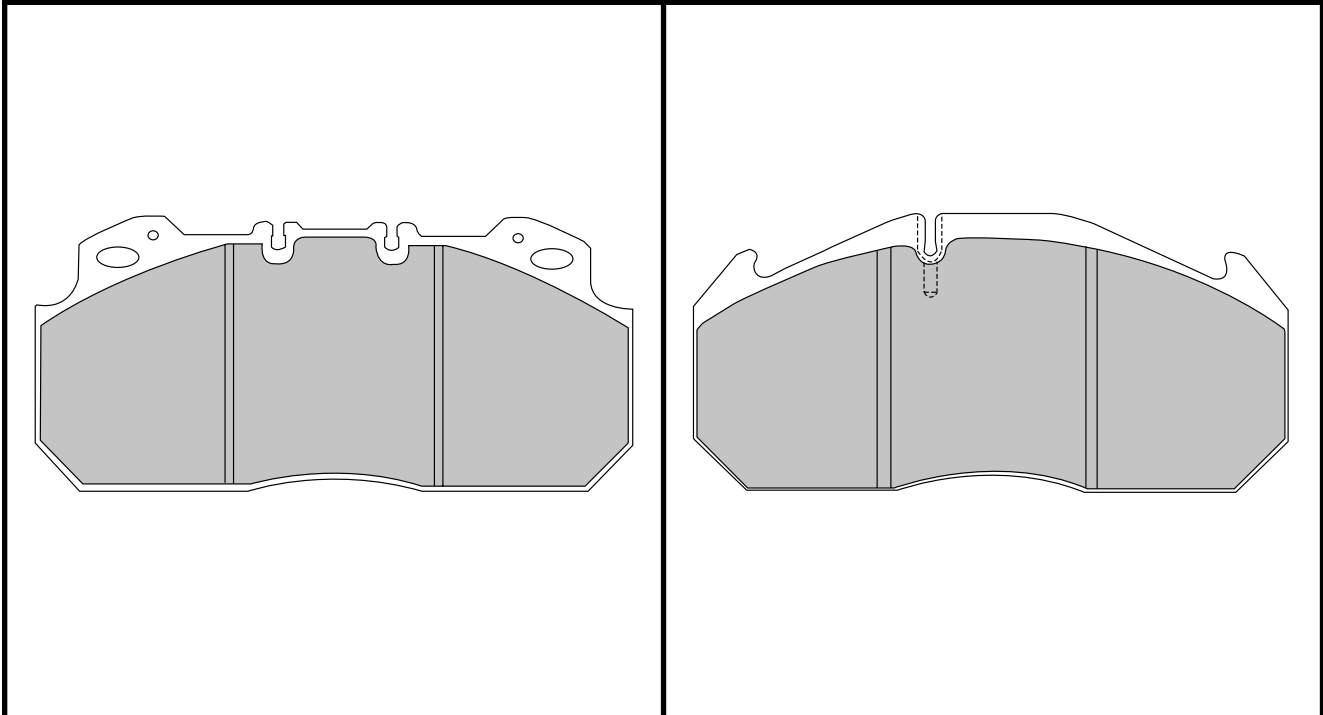

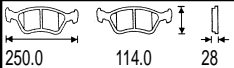
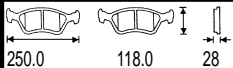
<b>ACV029</b>	<b>DENNIS HEULIEZ MERITOR RENAULT TRAILERS VOLVO</b>	<b>ACV030</b>	<b>AUWARTER, DENNIS ERF, HEULIEZ KAROSA, KASSBOHRER MAN, MERCEDES MERITOR, RENAULT VAN HOOL</b>
			
<b>WVA: 29090</b>		<b>WVA: 29053</b>	

Remarks: 4 identical pads





# Disc Brake Pads Illustrations

**ANL  
Braking**

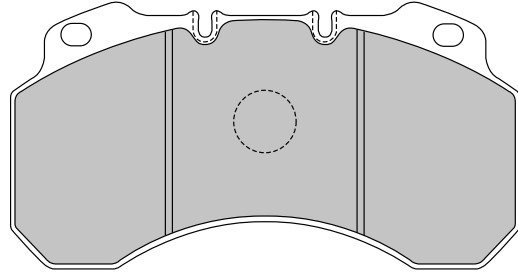
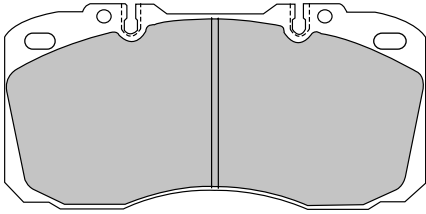

<b>ACV032</b>	<b>IVECO</b>
<b>WVA: 29122</b>	

<b>ACV033</b>	<b>MERITOR NISSAN RENAULT TRAILERS VAN HOOL</b>
<b>WVA: 29100</b>	

Remarks: 4 identical pads

Remarks: 4 identical pads with hole in backplate for wear indicator

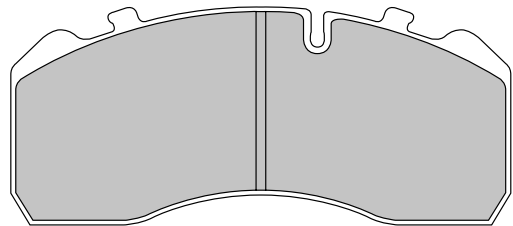
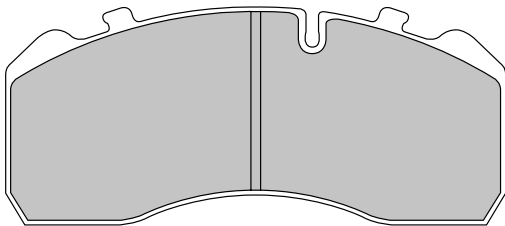

<b>ACV036</b>	<b>AUWARTER DAF MAN MERCEDES</b>
<b>WVA: 29093</b>	

<b>ACV037</b>	<b>AUWARTER MAN MERCEDES</b>
<b>WVA: 29095</b>	

Remarks: 4 identical pads

Remarks: 4 identical pads



# Disc Brake Pads Illustrations

**ANL  
Braking**

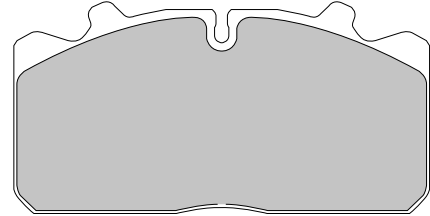
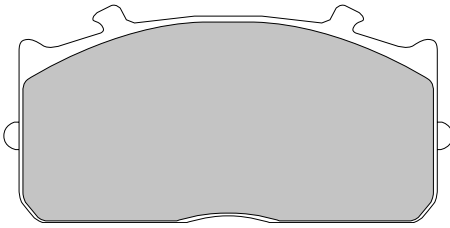
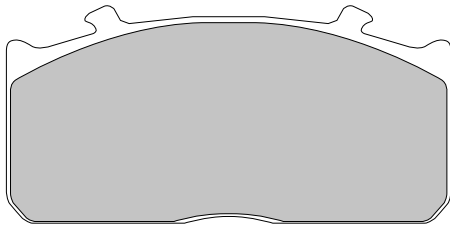

<b>ACV038</b>
173.6    84    34.00/27.00
<b>WVA: 29115</b>

<b>DISCOS</b>
<b>GRANNING LYNX</b>
<b>KNORR - BREMSEN</b>
<b>MERCEDES</b>
<b>SAE DUPILLIER</b>
<b>TRAILERS</b>

<b>ACV039</b>
175.6    85.6    26
<b>WVA: 29088</b>

<b>DA</b>
<b>IVECO</b>
<b>MAN</b>
<b>OPTARE</b>
<b>RENAULT</b>

Remarks: 2 pairs of pads

Remarks: 4 identical pads

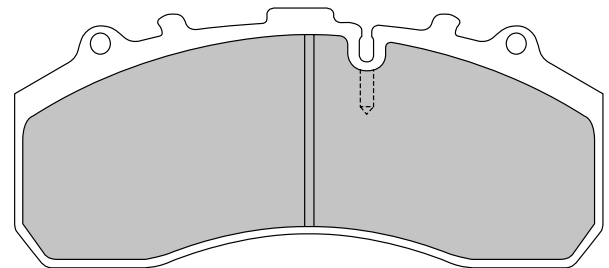
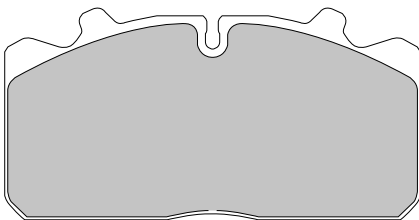

<b>ACV040</b>
175.6    85.6    27
<b>WVA: 29091</b>

<b>DAF</b>
<b>IVECO</b>
<b>MAN</b>
<b>RENAULT</b>

<b>ACV041</b>
248.0    108.0    30
<b>WVA: 29106</b>

<b>AUWARTER, DAF</b>
<b>DENNIS, IVECO</b>
<b>KAROSA, KASSBOHRER</b>
<b>KNORR - BREMSEN</b>
<b>LIAZ, MERCEDES</b>
<b>SCANIA</b>

Remarks: 4 identical pads

Remarks: 4 identical pads



# Disc Brake Pads Illustrations

**ANL  
Braking**

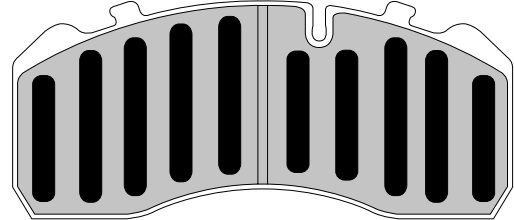
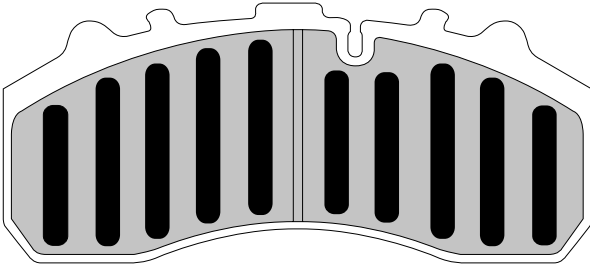

<b>ACV042</b>	BPW AXLES, DISCOS FRUEHAUF, GRANNING LYNX HENDRICKSON, LECINENA MERCEDES AXLES SAE DUPILLIER, SAF / SAUER TRAILERS, YORK, ZF AXLES
<b>WVA: 29108</b>	

<b>ACV043</b>	BPW AXLES, DISCOS GRANNING LYNX KNORR - BREMSEN SAE DUPILLIER SAF / SAUER, TRAILERS ZF AXLES
<b>WVA: 29095</b>	

Remarks: 4 identical pads with rapid bedding strips

Remarks: 4 identical pads with rapid bedding strips

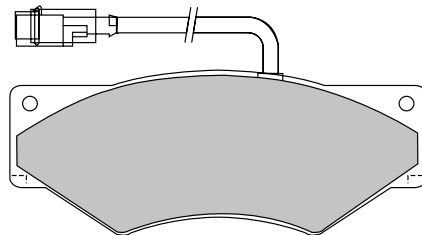
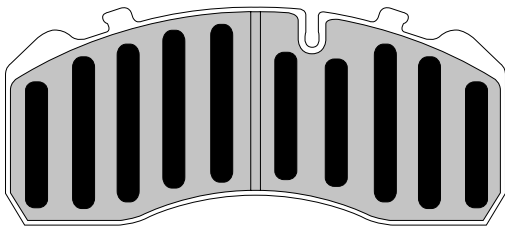

<b>ACV044</b>	BPW AXLES GRANNING LYNX SAE DUPILLIER SAF / SAUER ZF AXLES
<b>WVA: 29095</b>	

<b>ACV045</b>	IVECO
<b>WVA: 29107</b>	

Remarks: 4 identical pads with rapid bedding strips

Remarks: 2 plain pads, 2 pads with wear indicators



# Disc Brake Pads Illustrations

**ANL  
Braking**

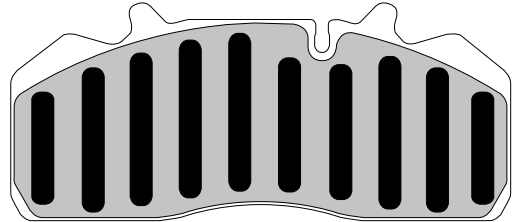
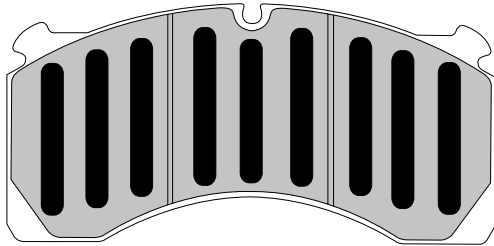

<p><b>ACV047</b></p>	<p><b>MERITOR TRAILERS</b></p>	<p><b>ACV048</b></p>	<p><b>DISCOS FRUEHAUF MERCEDES AXLES SAF / SAUER TRAILERS WABCO BRAKES</b></p>
<p><b>WVA: 29124</b></p>		<p><b>WVA: 29126</b></p>	

Remarks: 4 identical pads with rapid bedding strips

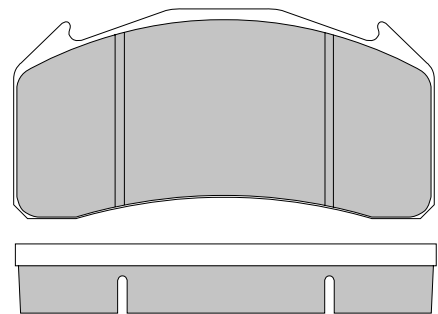
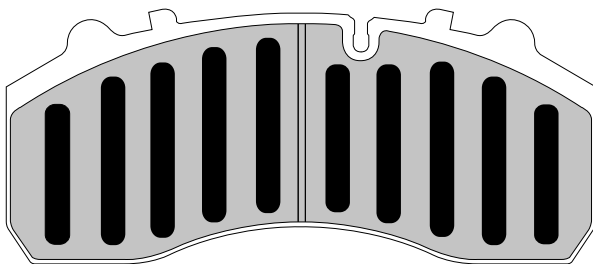

<p><b>ACV049</b></p>	<p><b>DAF, DISCOS FRUEHAUF MERCEDES AXLES SAF / SAUER TRAILERS WABCO BRAKES</b></p>	<p><b>ACV050</b></p>	<p><b>MERITOR TRAILERS VOLVO</b></p>
<p><b>WVA: 29146</b></p>		<p><b>WVA: 29136</b></p>	

Remarks: 4 identical pads with rapid bedding strips



# Disc Brake Pads Illustrations

## ANL Braking

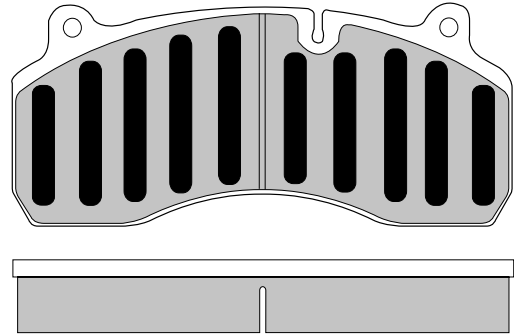
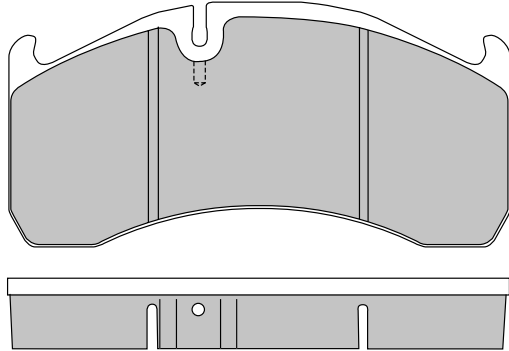

<b>ACV051</b>
<b>WVA: 29137</b>

<b>MERITOR TRAILERS VOLVO</b>
---------------------------------------

<b>ACV053</b>
<b>WVA: 29147</b>

<b>FRUEHAUF HALDEX BRAKES MERCEDES AXLES TRAILERS</b>
---

Remarks: 4 identical pads

Remarks: 4 identical pads with rapid bedding strips

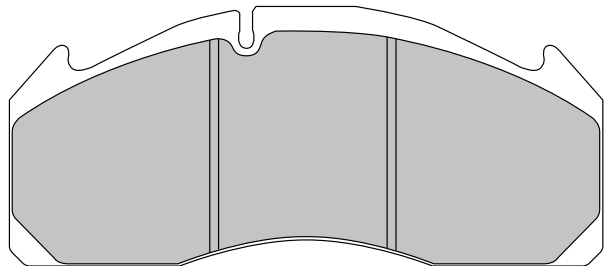
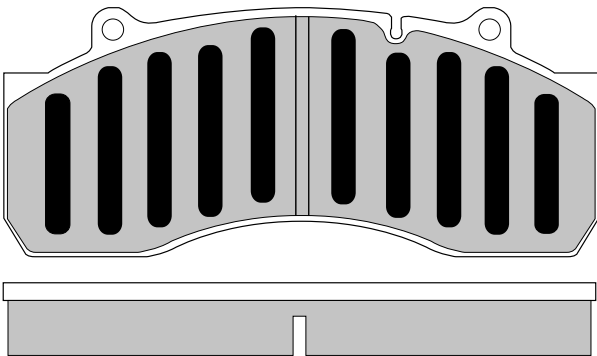

<b>ACV054</b>
<b>WVA: 29143</b>

<b>DISCOS FRUEHAUF HALDEX BRAKES MERCEDES AXLES SAF / SAUER TRAILERS</b>
--

<b>ACV055</b>
<b>WVA: 29125</b>

<b>MERITOR TRAILERS VOLVO</b>
---------------------------------------

Remarks: 4 identical pads with rapid bedding strips

Remarks: 4 identical pads



# Disc Brake Pads Illustrations

**ANL  
Braking**

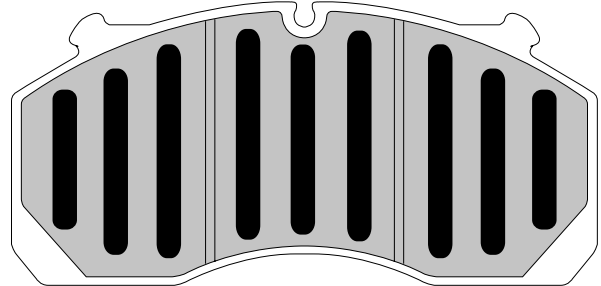
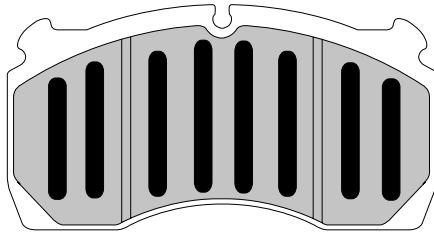

<b>ACV056</b>
<b>WVA: 29149</b>

<b>AUTODROMO MERITOR TRAILERS</b>
---

<b>ACV057</b>
<b>WVA: 29150</b>

<b>DEN OUDSTEN MERITOR TRAILERS</b>
---

Remarks: 4 identical pads with rapid bedding strips

Remarks: 4 identical pads with rapid bedding strips

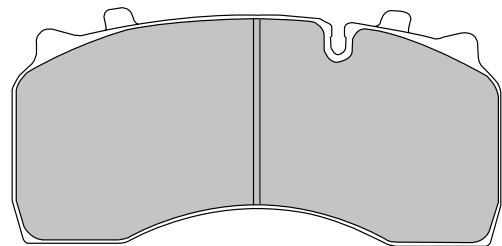
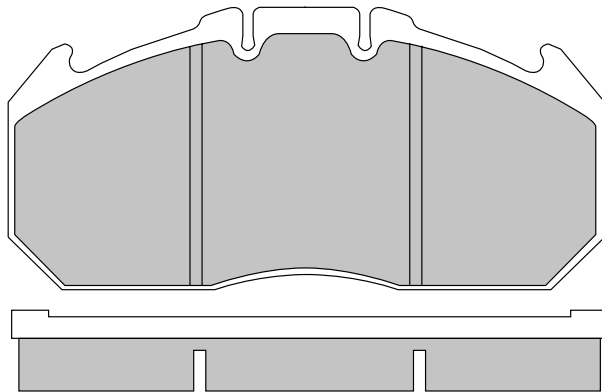

<b>ACV058</b>
<b>WVA: 29131</b>

<b>ERF MAN MERITOR RENAULT TRAILERS</b>
---

<b>ACV059</b>
<b>WVA: 29141</b>

<b>DAF DENNIS</b>
-----------------------

Remarks: 4 identical pads

Remarks: 4 identical pads



# Disc Brake Pads Illustrations

## ANL Braking

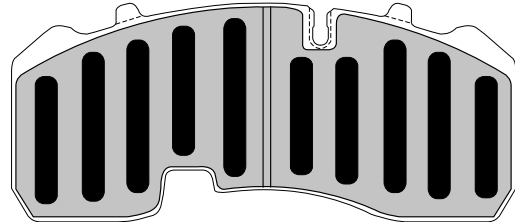
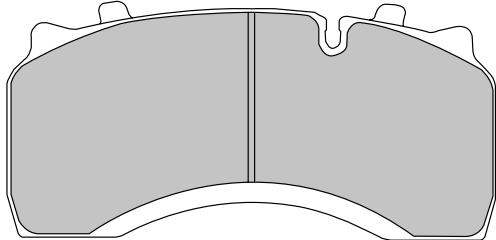

<b>ACV060</b>	RENAULT	
	204.6	99.6 30
<b>WVA: 29142</b>		

<b>ACV061</b>	BPW AXLES KNORR - BREMSEN TRAILERS ZF AXLES	
	210	92 29
<b>WVA: 29165</b>		

Remarks: 4 identical pads

Remarks: 4 identical pads with rapid bedding strips

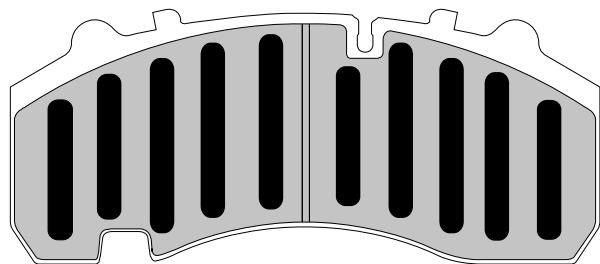
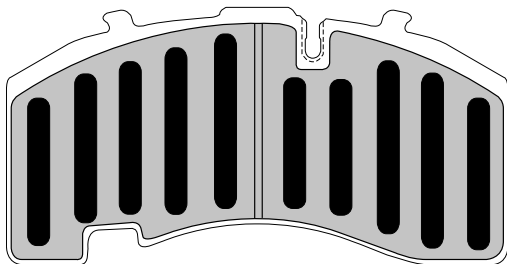

<b>ACV062</b>	BPW AXLES KNORR - BREMSEN TRAILERS ZF AXLES	
	210	108 29
<b>WVA: 29171</b>		

<b>ACV063</b>	BPW AXLES KNORR - BREMSEN MERCEDES TRAILERS ZF AXLES	
	247	110 29
<b>WVA: 29167</b>		

Remarks: 4 identical pads with rapid bedding strips

Remarks: 4 identical pads with rapid bedding strips



# Disc Brake Pads Illustrations

**ANL  
Braking**

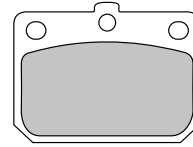
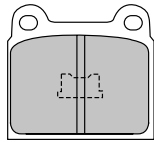

**ADB0101**

**VOLKSWAGEN**

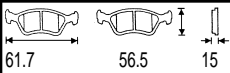

**WVA: 20228**

**ADB0111**

**HYUNDAI  
NISSAN**

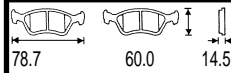

**WVA: 20703**

Remarks: 4 identical pads

Remarks: 4 identical pads

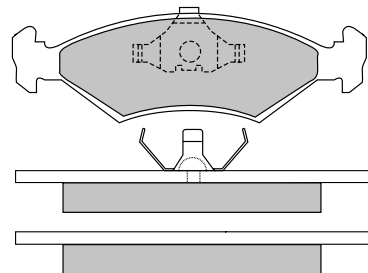
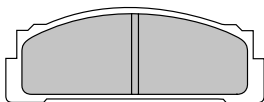

**ADB0112**

**FIAT  
FSO**

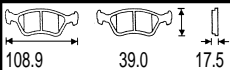

**WVA: 20073**

**ADB0118**

**FORD**

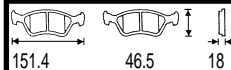

**WVA: 20753**

Remarks: 4 identical pads

Remarks: 2 plain pads, 2 pads with spring clips





# Disc Brake Pads Illustrations

**ANL  
Braking**

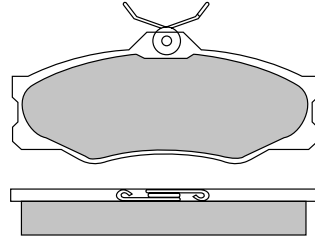
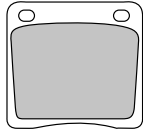

<b>ADB0122</b>
<b>WVA: 20128</b>

<b>NISSAN</b>
---------------

<b>ADB0124</b>
<b>WVA: 20979</b>

<b>VOLKSWAGEN</b>
-------------------

Remarks: 4 identical pads

Remarks: 4 identical pads

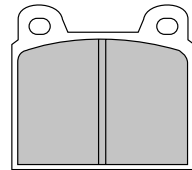
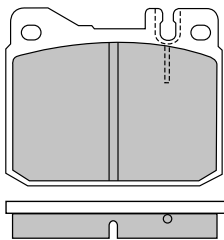

<b>ADB0125</b>
<b>WVA: 20392</b>

<b>MERCEDES</b>
-----------------

<b>ADB0128</b>
<b>WVA: 20011</b>

<b>VOLKSWAGEN</b>
-------------------

Remarks: 4 identical pads

Remarks: 4 identical pads



# Disc Brake Pads Illustrations

**ANL  
Braking**

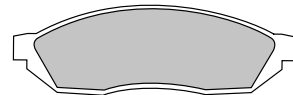
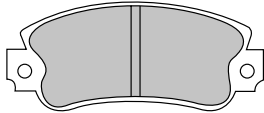

<b>ADB0129</b>
<b>WVA: 20950</b>

<b>FIAT SEAT</b>
----------------------

<b>ADB0130</b>
<b>WVA: 20731</b>

<b>SUZUKI VAUXHALL</b>
----------------------------

Remarks: 4 identical pads

Remarks: 4 identical pads

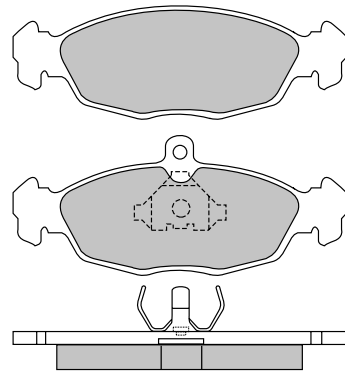
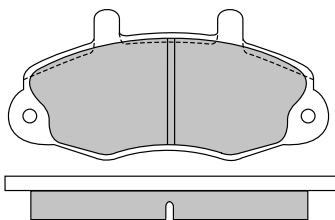

<b>ADB0132</b>
<b>WVA: 21470</b>

<b>FORD</b>
-------------

<b>ADB0134</b>
<b>WVA: 20547</b>

<b>VAUXHALL</b>
-----------------

Remarks: 4 identical pads

Remarks: 2 plain pads, 2 pads with springs



# Disc Brake Pads Illustrations

**ANL  
Braking**

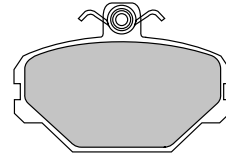
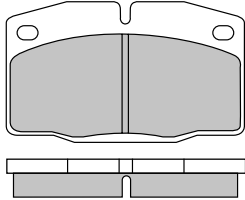

<b>ADB0135</b>	<b>VAUXHALL</b>
<b>WVA: 20939</b>	

<b>ADB0142</b>	<b>FSO</b>
<b>WVA: 21100</b>	

Remarks: 4 identical pads

Remarks: 4 identical pads

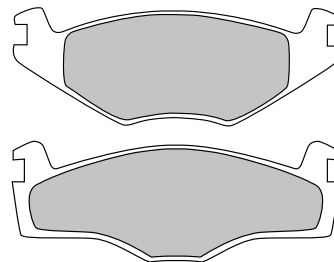
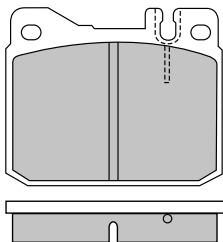

<b>ADB0147</b>	<b>MERCEDES</b>
<b>WVA: 20341</b>	

<b>ADB0149</b>	<b>SEAT VOLKSWAGEN</b>
<b>WVA: 20887</b>	

Remarks: 4 identical pads

Remarks: 2 pairs of pads



# Disc Brake Pads Illustrations

**ANL  
Braking**

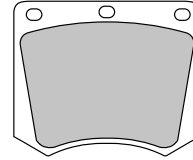
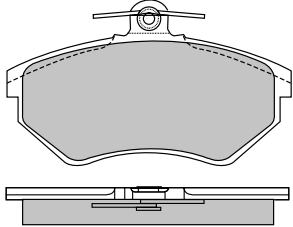

**ADB0152**

**VOLKSWAGEN**

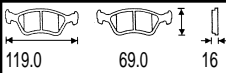

**WVA: 20168**

**ADB0156**

**FORD**

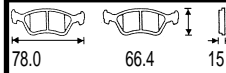

**WVA: 20491**

Remarks: 4 identical pads

Remarks: 4 identical pads

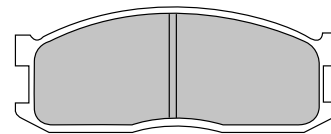
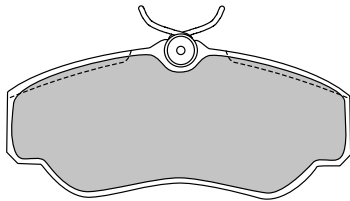

**ADB0162**

**LAND ROVER**

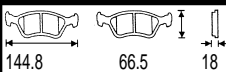

**WVA: 23452**

**ADB0168**

**KIA  
MAZDA**

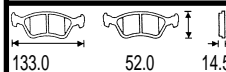

**WVA: 20002**

Remarks: 4 identical pads

Remarks: 4 identical pads



# Disc Brake Pads Illustrations

**ANL  
Braking**

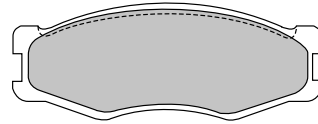
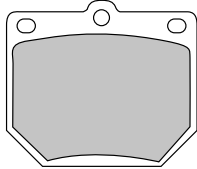

<b>ADB0171</b>	<b>NISSAN</b>
 77.8    68.7    15.3	
<b>WVA: 20289</b>	

--	--

<b>ADB0177</b>	<b>L.D.V NISSAN</b>
 129.9    49.0    17	
<b>WVA: 21099</b>	

--	--

Remarks: 4 identical pads

Remarks: 4 identical pads

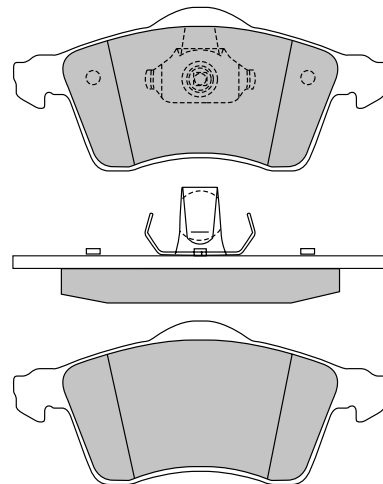
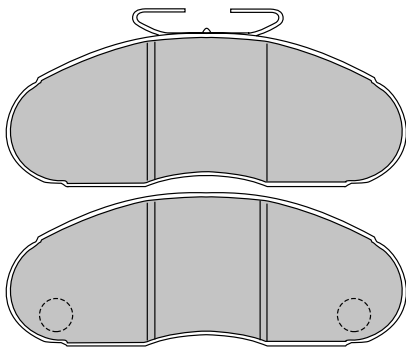

<b>ADB0183</b>	<b>MERCEDES NISSAN RENAULT</b>
 168.0    62.0    17	
<b>WVA: 29071</b>	

--	--

<b>ADB0186</b>	<b>VOLKSWAGEN</b>
 156.4    68.5    20	
<b>WVA: 21883</b>	

--	--

Remarks: 2 plain pads with 14mm plain holes, 2 pads with springs

Remarks: 2 plain pads, 2 pads with spring clips



# Disc Brake Pads Illustrations

**ANL  
Braking**

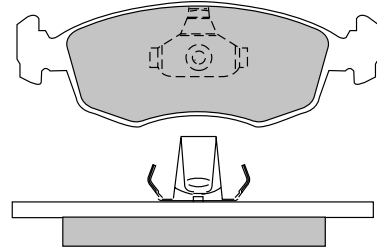
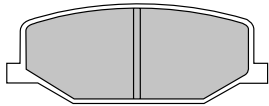

**ADB0195**

**SUZUKI**

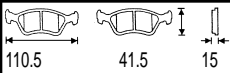

110.5 41.5 15

**WVA: 21142**

**ADB0201**

**FIAT**

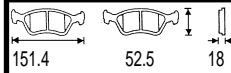

151.4 52.5 18

**WVA: 23552**

Remarks: 4 identical pads

Remarks: 2 plain pads, 2 pads with spring clips

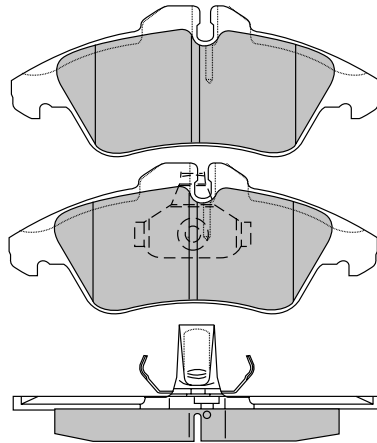
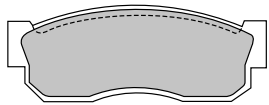

**ADB0207**

**NISSAN  
SUBARU**

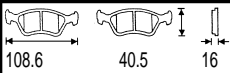

108.6 40.5 16

**WVA: 20958**

**ADB0212**

**MERCEDES  
VOLKSWAGEN**

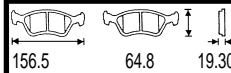

156.5 64.8 19.30

**WVA: 21576**

Remarks: 4 identical pads

Remarks: 2 plain pads, 2 pads with spring clips



# Disc Brake Pads Illustrations

**ANL  
Braking**

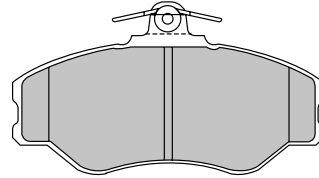
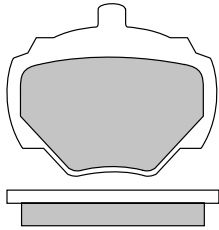

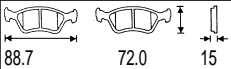
<b>ADB0224</b>

<b>WVA: 20344</b>

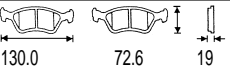
<b>LAND ROVER</b>
-------------------

<b>ADB0225</b>

<b>WVA: 23083</b>

<b>HYUNDAI</b>
----------------

Remarks: 4 identical pads

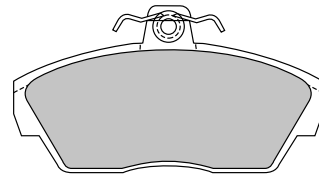
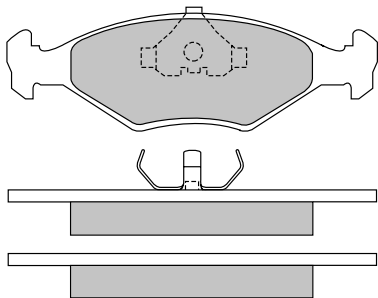
Remarks: 4 identical pads

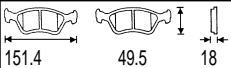

<b>ADB0228</b>

<b>WVA: 21193</b>

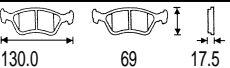
<b>FIAT</b>
-------------

<b>ADB0232</b>

<b>WVA: 21515</b>

<b>LAND ROVER</b>
-------------------

Remarks: 2 plain pads, 2 pads with springs

Remarks: 4 identical pads



# Disc Brake Pads Illustrations

**ANL  
Braking**

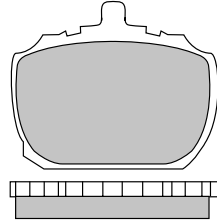
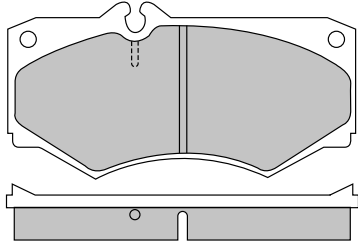

**ADB0238**

**MERCEDES**

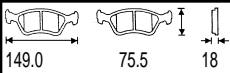

**WVA: 20784**

**ADB0239**

**FORD  
L.D.V  
VAUXHALL**

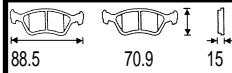

**WVA: 20364**

Remarks: 4 identical pads

Remarks: 2 pairs of pads (handed)

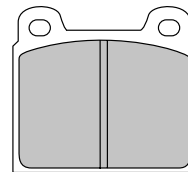
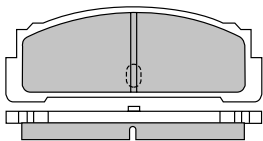

**ADB0243**

**FSO**

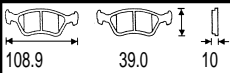

**WVA: 20074**

**ADB0247**

**VOLKSWAGEN**

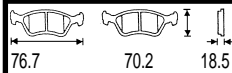

**WVA: 20011**

Remarks: 4 identical pads

Remarks: 4 identical pads





# Disc Brake Pads Illustrations

**ANL  
Braking**

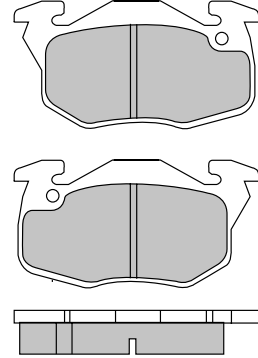
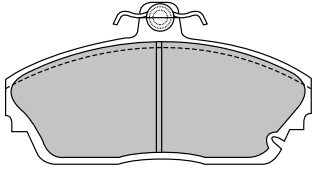

<b>ADB0256</b>	<b>TATA</b>
<b>WVA: 21245</b>	

<b>ADB0258</b>	<b>PEUGEOT RENAULT</b>
<b>WVA: 20905</b>	

Remarks: 4 identical pads

Remarks: 2 pairs of pads (handed)

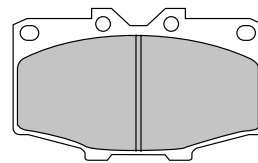
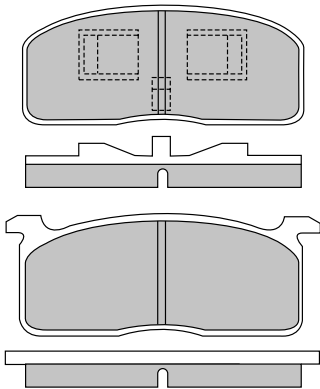

<b>ADB0264</b>	<b>TOYOTA</b>
<b>WVA: 20729</b>	

<b>ADB0265</b>	<b>TOYOTA</b>
<b>WVA: 20852</b>	

Remarks: 2 pairs of pads

Remarks: 4 identical pads



# Disc Brake Pads Illustrations

**ANL  
Braking**

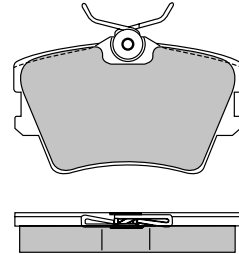
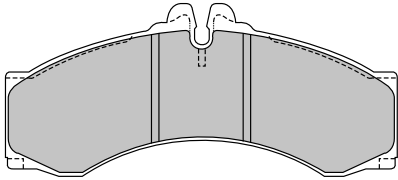

<b>ADB0271</b>
165.0    73.0    19.5
<b>WVA: 29076</b>

<b>MERCEDES VOLKSWAGEN</b>
--------------------------------

<b>ADB0272</b>
95.0    57.5    17
<b>WVA: 21882</b>

<b>VOLKSWAGEN</b>
-------------------

Remarks: 4 identical pads

Remarks: 4 identical pads

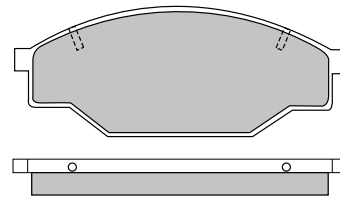
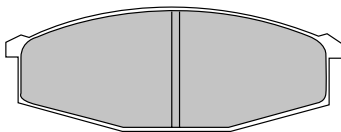

<b>ADB0276</b>
142.0    53.0    16.5
<b>WVA: 20863</b>

<b>NISSAN</b>
---------------

<b>ADB0297</b>
142.0    55.5    15
<b>WVA: 21158</b>

<b>TOYOTA VOLKSWAGEN</b>
------------------------------

Remarks: 4 identical pads

Remarks: 4 identical pads



# Disc Brake Pads Illustrations

**ANL  
Braking**

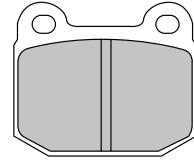
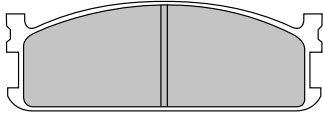

<b>ADB0306</b>	<b>ISUZU VAUXHALL</b>
<b>WVA: 21115</b>	

--	--

<b>ADB0312</b>	<b>STEYR-DAIMLER-PUCH</b>
<b>WVA: 20323</b>	

--	--

Remarks: 4 identical pads

Remarks: 4 identical pads

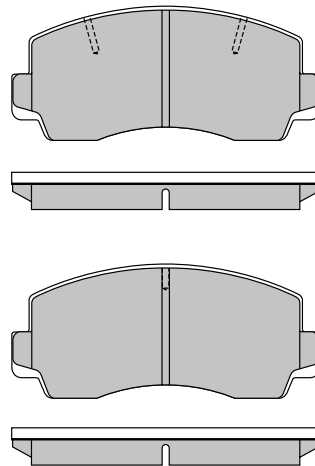
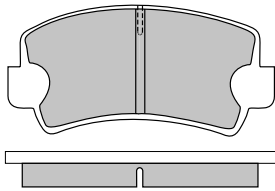

<b>ADB0313</b>	<b>MAZDA</b>
<b>WVA: 20313</b>	

--	--

<b>ADB0316</b>	<b>MAZDA MITSUBISHI</b>
<b>WVA: 21109</b>	

--	--

Remarks: 4 identical pads

Remarks: 4 identical pads



# Disc Brake Pads Illustrations

**ANL  
Braking**

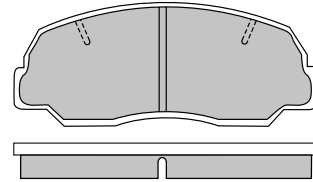
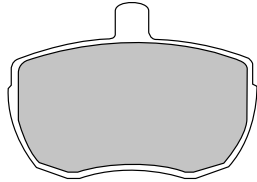

<b>ADB0319</b>
<b>WVA: 20359</b>

<b>ALFA ROMEO</b> <b>FORD</b> <b>IVECO</b> <b>L.D.V</b> <b>LAND ROVER</b> <b>TAXIS</b>
---

<b>ADB0323</b>
<b>WVA: 21243</b>

<b>MAZDA</b>
--------------

Remarks: 4 identical pads

Remarks: 4 identical pads

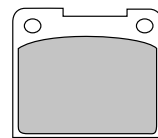
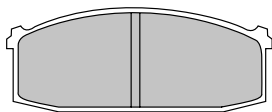

<b>ADB0368</b>
<b>WVA: 20718</b>

<b>NISSAN</b>
---------------

<b>ADB0389</b>
<b>WVA: 20088</b>

<b>FORD</b>
-------------

Remarks: 4 identical pads

Remarks: 4 identical pads



# Disc Brake Pads Illustrations

**ANL  
Braking**

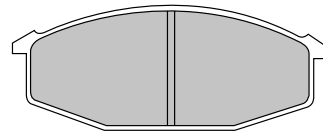
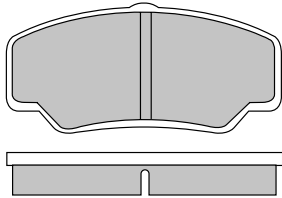

<b>ADB0390</b>	<b>FORD</b>
<b>WVA: 21141</b>	

<b>ADB0391</b>	<b>NISSAN</b>
<b>WVA: 20628</b>	

Remarks: 4 identical pads

Remarks: 4 identical pads

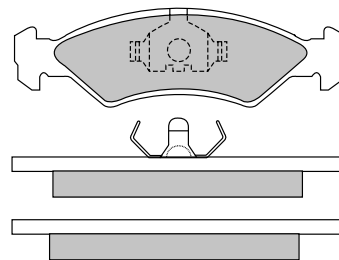
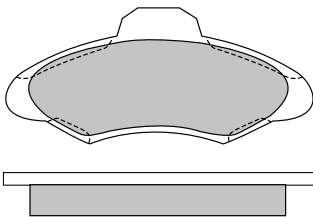

<b>ADB0393</b>	<b>FORD</b>
<b>WVA: 21171</b>	

<b>ADB0397</b>	<b>FORD</b>
<b>WVA: 20857</b>	

Remarks: 4 identical pads

Remarks: 2 plain pads, 2 pads with spring clips



# Disc Brake Pads Illustrations

**ANL  
Braking**

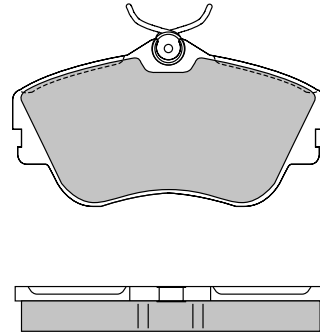
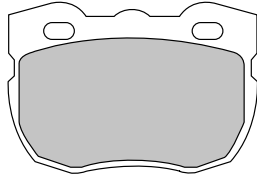

<b>ADB0401</b>
<b>WVA: 21459</b>

<b>LAND ROVER MCW TAXIS</b>
-------------------------------------

<b>ADB0419</b>
<b>WVA: 21479</b>

<b>VOLKSWAGEN</b>
-------------------

Remarks: 4 identical pads

Remarks: 4 identical pads

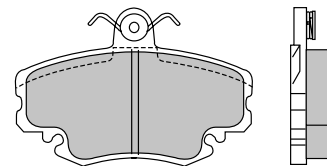
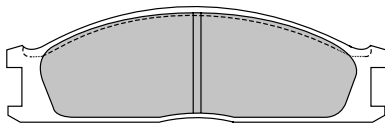

<b>ADB0423</b>
<b>WVA: 21347</b>

<b>FORD NISSAN</b>
------------------------

<b>ADB0431</b>
<b>WVA: 21463</b>

<b>RENAULT</b>
----------------

Remarks: 4 identical pads

Remarks: 4 identical pads



# Disc Brake Pads Illustrations

**ANL  
Braking**

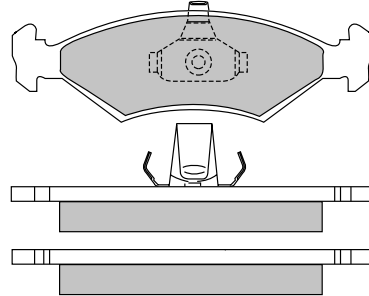
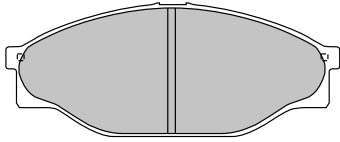

<b>ADB0440</b>	<b>TOYOTA</b>
<b>WVA: 21689</b>	

<b>ADB0444</b>	<b>FORD</b>
<b>WVA: 23104</b>	

Remarks: 4 identical pads

Remarks: 2 plain pads, 2 pads with spring clips

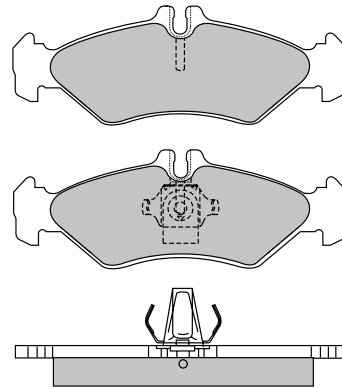
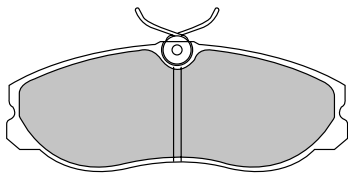

<b>ADB0447</b>	<b>FORD L.D.V NISSAN</b>
<b>WVA: 21481</b>	

<b>ADB0453</b>	<b>MERCEDES VOLKSWAGEN</b>
<b>WVA: 21621</b>	

Remarks: 4 identical pads

Remarks: 2 plain pads, 2 pads with spring clips



# Disc Brake Pads Illustrations

**ANL  
Braking**

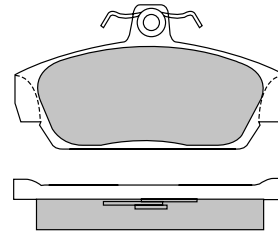
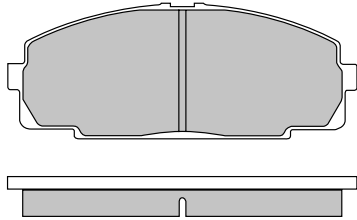

**ADB0459**

**TOYOTA**

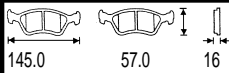

**WVA: 21468**

**ADB0467**

**ROVER**

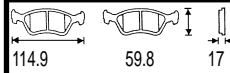

**WVA: 21518**

Remarks: 4 identical pads

Remarks: 4 identical pads

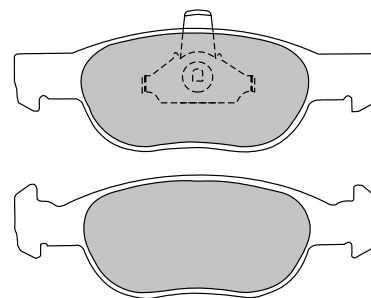
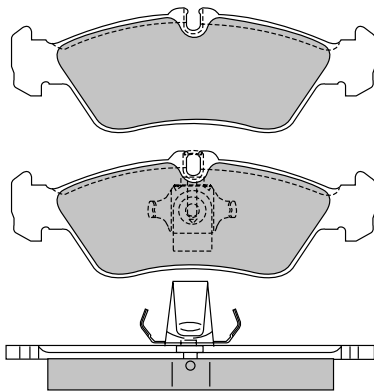

**ADB0478**

**MERCEDES  
VOLKSWAGEN**

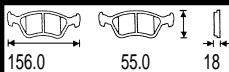

**WVA: 21592**

**ADB0479**

**FIAT**

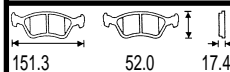

**WVA: 21930**

Remarks: 2 plain pads, 2 pads with spring clips

Remarks: 2 plain pads, 2 pads with spring clips





# Disc Brake Pads Illustrations

**ANL  
Braking**

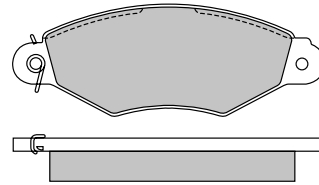
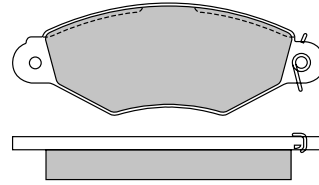
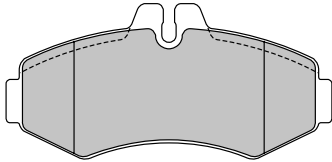

<b>ADB0480</b>	<b>MERCEDES</b>
<b>WVA: 23022</b>	

--	--

<b>ADB0485</b>	<b>RENAULT</b>
<b>WVA: 21978</b>	

--	--

Remarks: 4 identical pads

Remarks: 2 pairs of pads with springs

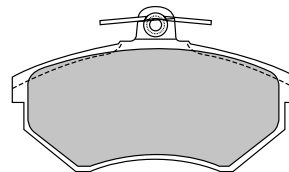
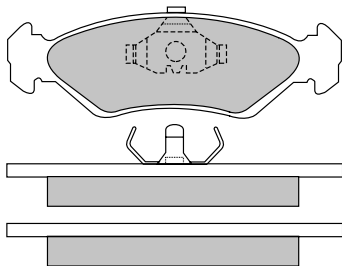

<b>ADB0502</b>	<b>FORD</b>
<b>WVA: 21202</b>	

--	--

<b>ADB0511</b>	<b>SEAT VOLKSWAGEN</b>
<b>WVA: 20168</b>	

--	--

Remarks: 2 plain pads, 2 pads with spring clips

Remarks: 4 identical pads



# Disc Brake Pads Illustrations

**ANL  
Braking**

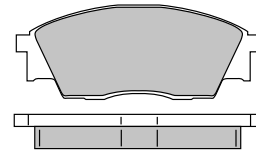
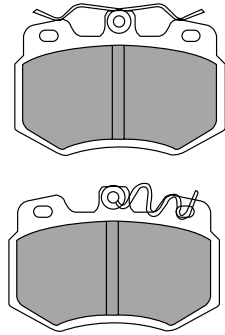

**ADB0515**

**PEUGEOT**

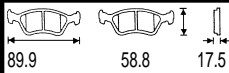

**WVA: 20988**

**ADB0552**

**SUBARU**

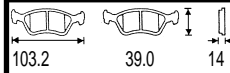

**WVA: 21542**

Remarks: 2 pairs of pads with springs

Remarks: 4 identical pads

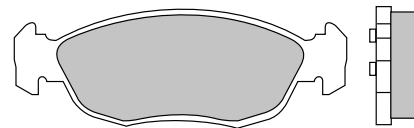
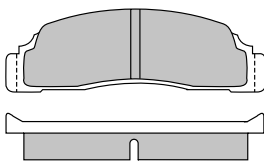

**ADB0567**

**FORD**

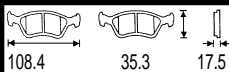

**WVA: 20422**

**ADB0570**

**PEUGEOT**

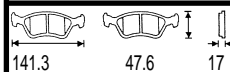

**WVA: 21827**

Remarks: 4 identical pads

Remarks: 2 plain pads, 2 pads with spring clips



# Disc Brake Pads Illustrations

**ANL  
Braking**

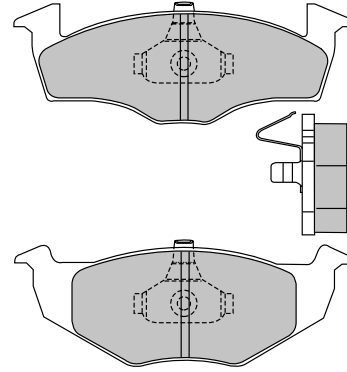
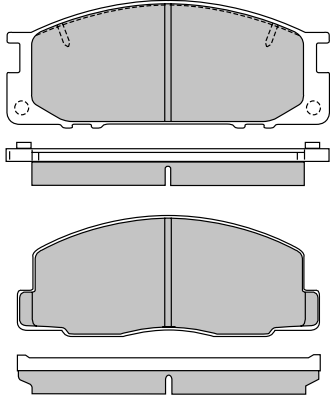

<b>ADB0589</b>	<b>TOYOTA</b>
<b>WVA: 21249</b>	

<b>ADB0706</b>	<b>VOLKSWAGEN</b>
<b>WVA: 21866</b>	

Remarks: 2 pairs of pads

Remarks: 2 pairs of pads with springs

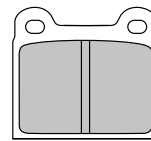
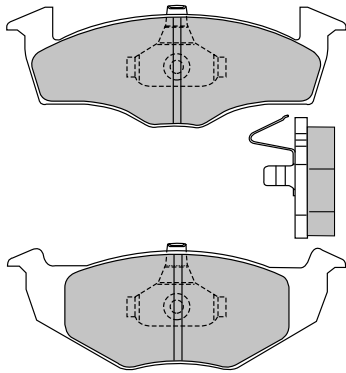

<b>ADB0707</b>	<b>SKODA</b>
<b>WVA: 21866</b>	

<b>ADB0731</b>	<b>VAUXHALL</b>
<b>WVA: 20034</b>	

Remarks: 2 pairs of pads with springs

Remarks: 4 identical pads



# Disc Brake Pads Illustrations

**ANL  
Braking**

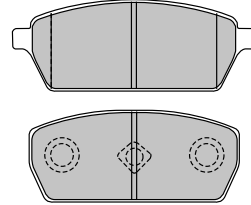
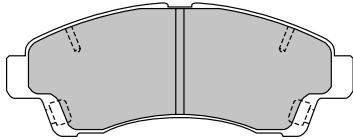

**ADB0733**

**MAZDA**

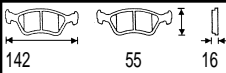

**WVA:**

**ADB0734**

**SUZUKI**

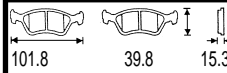

**WVA:**

Remarks: 2 plain pads, 2 pads with spring wear indicators (handed)

Remarks: 2 pairs of pads

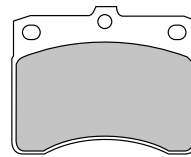
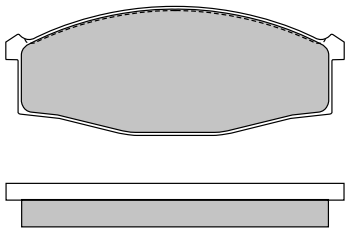

**ADB0758**

**NISSAN**

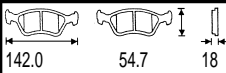

**WVA:**

**ADB0770**

**DAIHATSU  
PIAGGIO**

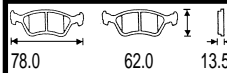

**WVA: 20780**

Remarks: 4 identical pads

Remarks: 4 identical pads



# Disc Brake Pads Illustrations

**ANL  
Braking**

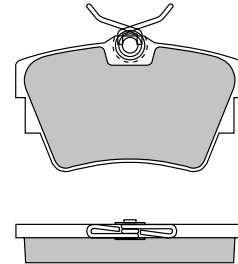
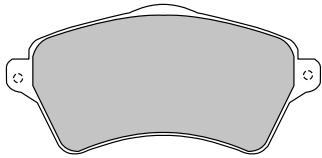

<b>ADB0873</b>
<b>WVA: 23615</b>

<b>LAND ROVER</b>
-------------------

<b>ADB0874</b>
<b>WVA: 23224</b>

<b>NISSAN OPEL RENAULT VAUXHALL VOLKSWAGEN</b>
--

Remarks: 4 identical pads

Remarks: 4 identical pads

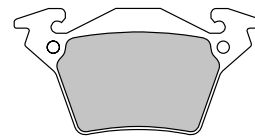
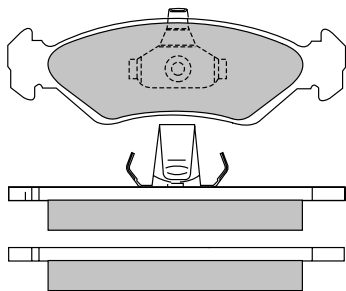

<b>ADB0876</b>
<b>WVA: 23102</b>

<b>FORD</b>
-------------

<b>ADB0888</b>
<b>WVA: 23020</b>

<b>MERCEDES</b>
-----------------

Remarks: 2 plain pads, 2 pads with spring clips

Remarks: 4 identical pads



# Disc Brake Pads Illustrations

**ANL  
Braking**

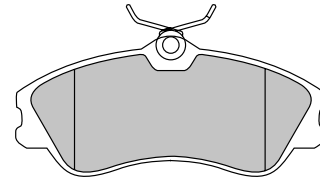
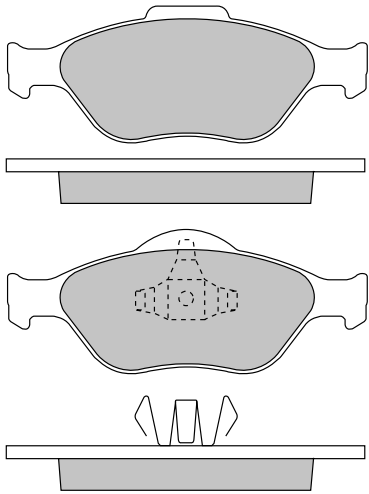

**ADB0891**

**FORD**

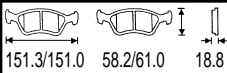

**WVA: 23202**

**ADB0892**

**CITROEN  
PEUGEOT**

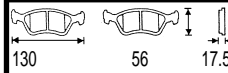

**WVA: 23346**

Remarks: 2 plain pads, 2 pads with springs

Remarks: 4 identical pads

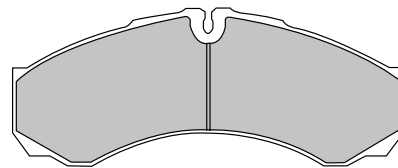
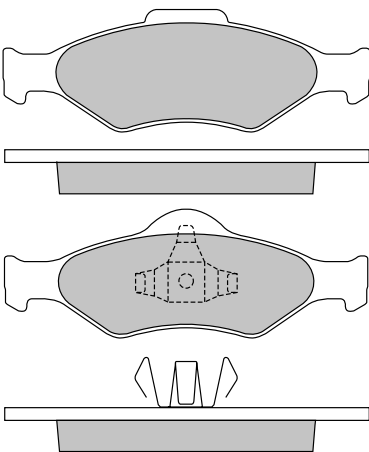

**ADB0899**

**FORD**

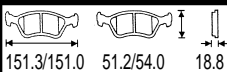

**WVA: 23200**

**ADB0909**

**IVECO**

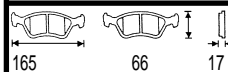

**WVA: 29121**

Remarks: 2 plain pads, 2 pads with springs

Remarks: 4 identical pads



# Disc Brake Pads Illustrations

**ANL  
Braking**

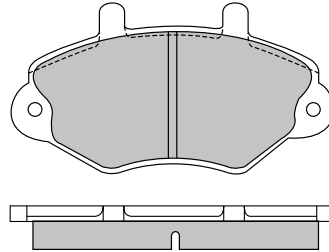
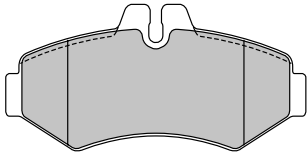

<b>ADB0914</b>
126      63      17.8
<b>WVA: 23021</b>

<b>MERCEDES VOLKSWAGEN</b>
--------------------------------

<b>ADB0924</b>
138.8      72.0      18
<b>WVA: 21469</b>

<b>FORD</b>
-------------

Remarks: 4 identical pads

Remarks: 4 identical pads

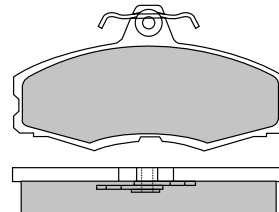
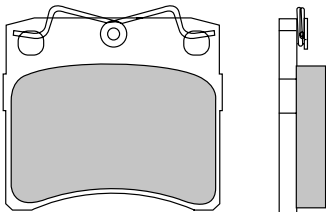

<b>ADB0925</b>
91.4      80.0      18
<b>WVA: 20652</b>

<b>VOLKSWAGEN</b>
-------------------

<b>ADB0928</b>
114.9      60.5      17.5
<b>WVA: 20861</b>

<b>SKODA VOLKSWAGEN</b>
-----------------------------

Remarks: 4 pads with spring clips

Remarks: 4 identical pads



# Disc Brake Pads Illustrations

**ANL  
Braking**

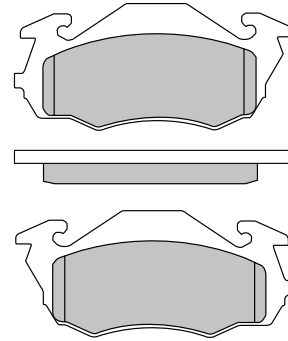
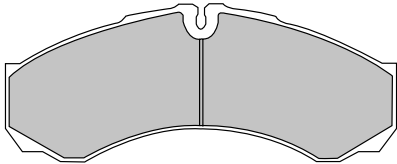

<b>ADB0931</b>
165      66      19.5
<b>WVA: 29121</b>

<b>IVECO RENAULT</b>
--------------------------

<b>ADB0952</b>
120      53      14.8
<b>WVA:</b>

<b>SUBARU</b>
---------------

Remarks: 4 identical pads

Remarks: 2 pairs of pads

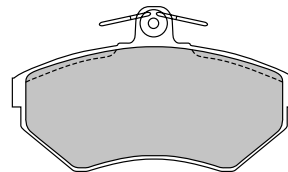
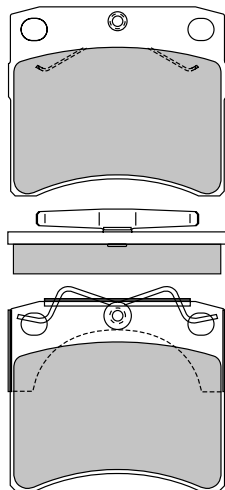

<b>ADB0953</b>
91.6      80      18
<b>WVA: 21634</b>

<b>VOLKSWAGEN</b>
-------------------

<b>ADB0989</b>
119.0      69.0      16
<b>WVA: 21945</b>

<b>VOLKSWAGEN</b>
-------------------

Remarks: 2 pairs of pads

Remarks: 4 identical pads





# Disc Brake Pads Illustrations

**ANL  
Braking**

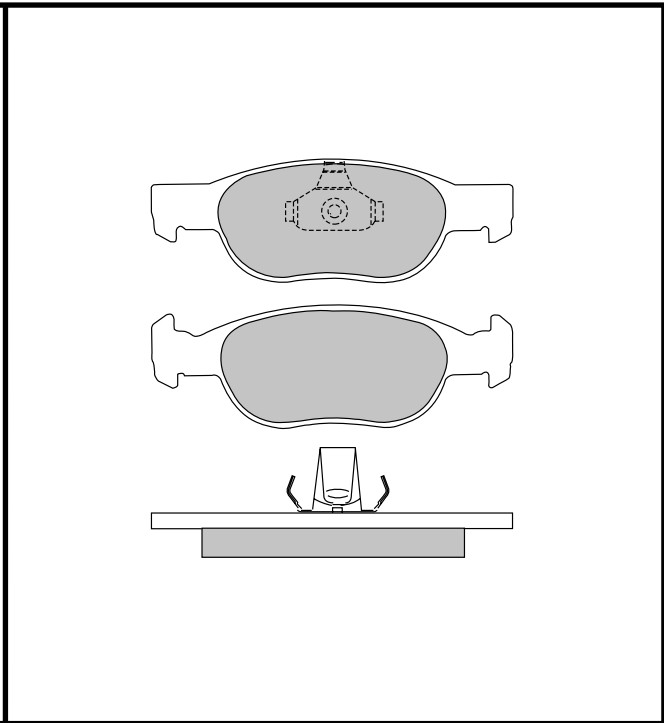
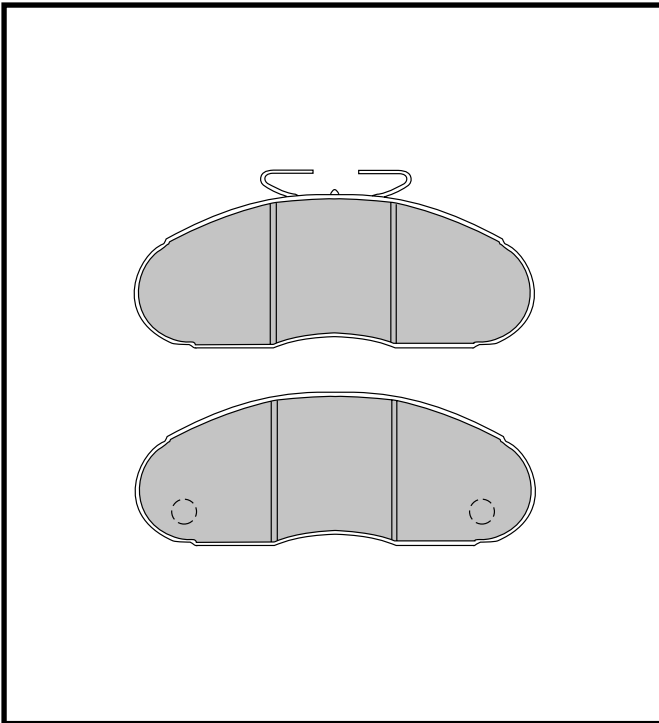

<b>ADB0991</b>
<b>WVA: 29706</b>

<b>MERCEDES NISSAN RENAULT</b>
--

<b>ADB01018</b>
<b>WVA: 23181</b>

<b>FIAT</b>
-------------

Remarks: 2 plain pads with 10mm tapped holes, 2 pads with springs

Remarks: 2 plain pads, 2 pads with spring clips

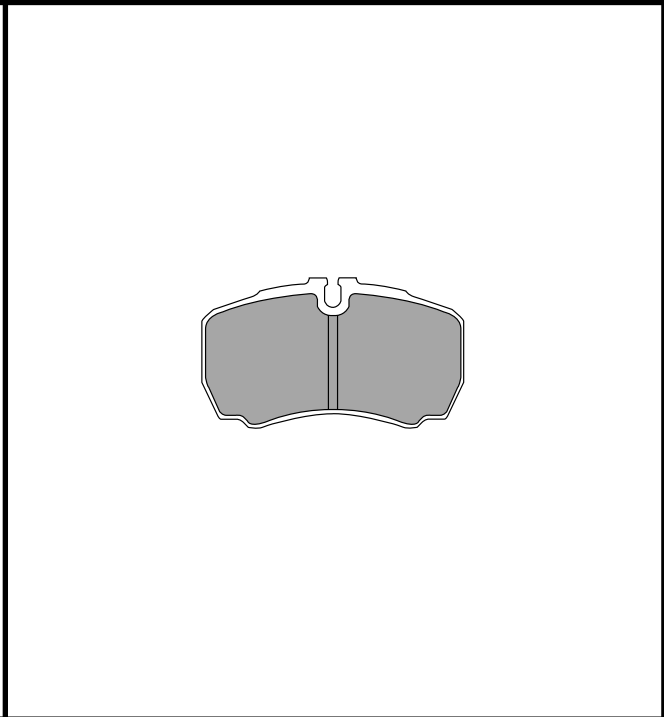
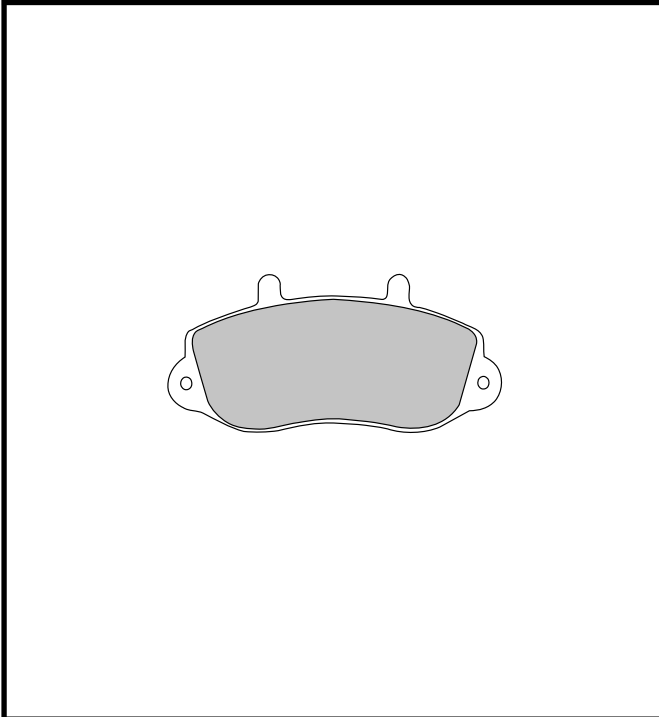

<b>ADB01021</b>
<b>WVA: 23302</b>

<b>OPEL RENAULT VAUXHALL</b>
--------------------------------------

<b>ADB01034</b>
<b>WVA: 29123</b>

<b>IVECO</b>
--------------

Remarks: 4 identical pads

Remarks: 4 identical pads



# Disc Brake Pads Illustrations

**ANL  
Braking**

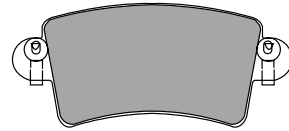
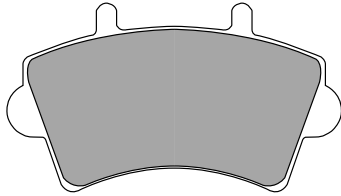

**ADB01035**

NISSAN  
OPEL  
RENAULT  
VAUXHALL

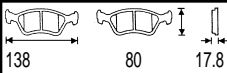

WVA: 23616

**ADB01036**

NISSAN  
OPEL  
RENAULT  
VAUXHALL

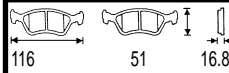

WVA: 23669

Remarks: 4 identical pads

Remarks: 4 identical pads

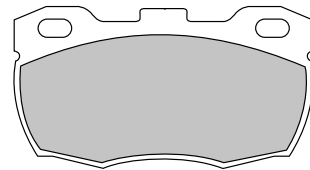
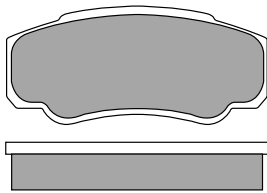

**ADB01042**

CITROEN  
FIAT  
PEUGEOT

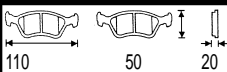

WVA:

**ADB01052**

LAND ROVER

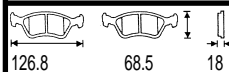

WVA: 21519

Remarks: 4 identical pads

Remarks: 4 identical pads



# Disc Brake Pads Illustrations

**ANL  
Braking**

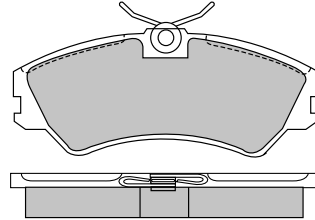
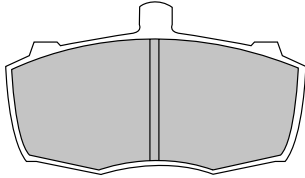

<b>ADB01066</b>
WVA: 20904

<b>FORD</b> <b>L.D.V</b> <b>LAND ROVER</b> <b>RENAULT</b>
--

<b>ADB01073</b>
WVA: 20124

<b>VOLKSWAGEN</b>
-------------------

Remarks: 4 identical pads

Remarks: 4 identical pads

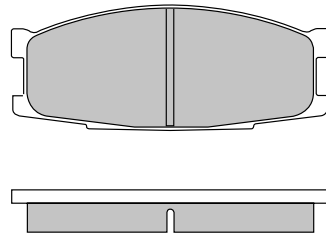
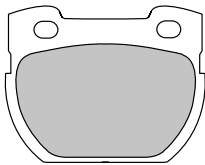

<b>ADB01078</b>
WVA: 23471

<b>LAND ROVER</b>
-------------------

<b>ADB01086</b>
WVA:

<b>MITSUBISHI</b>
-------------------

Remarks: 4 identical pads

Remarks: 4 identical pads



# Disc Brake Pads Illustrations

**ANL  
Braking**

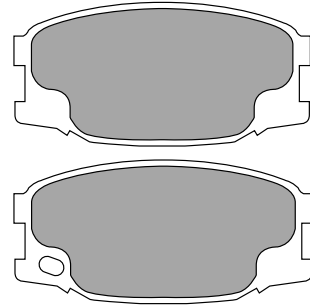
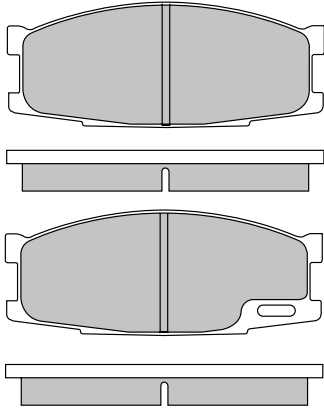

**ADB01087**

**MITSUBISHI**

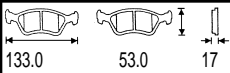

**WVA:**

**ADB01088**

**MITSUBISHI**

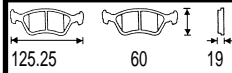

**WVA:**

Remarks: 2 pairs of pads

Remarks: 6 plain pads, 2 pads with holes for W/I

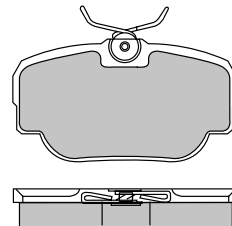
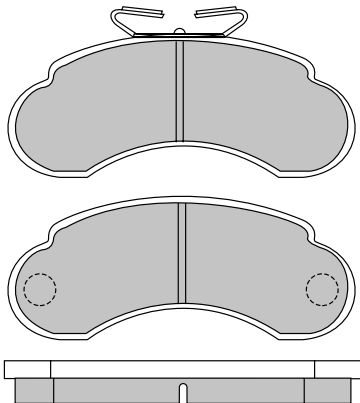

**ADB01089**

**MERCEDES**

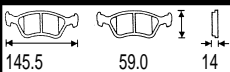

**WVA: 21573**

**ADB01093**

**LAND ROVER**

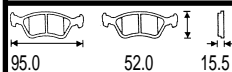

**WVA: 23458**

Remarks: 2 plain pads with 14mm plain holes, 2 pads with springs

Remarks: 2 pairs of pads



# Disc Brake Pads Illustrations

**ANL  
Braking**

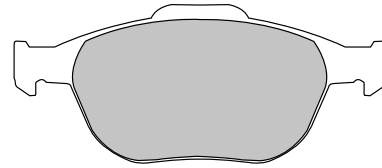
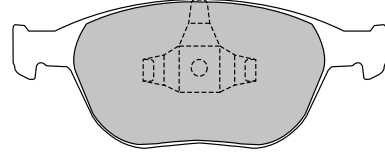
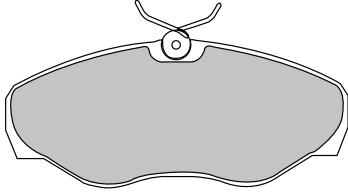

**ADB01127**

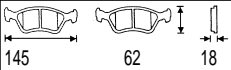

145 62 18

**WVA: 23099**

**NISSAN  
OPEL  
RENAULT  
VAUXHALL**

**ADB01150**

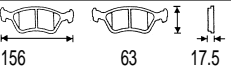

156 63 17.5

**WVA: 23440**

**FORD**

Remarks: 4 identical pads

Remarks: 2 plain pads, 2 pads with spring clips

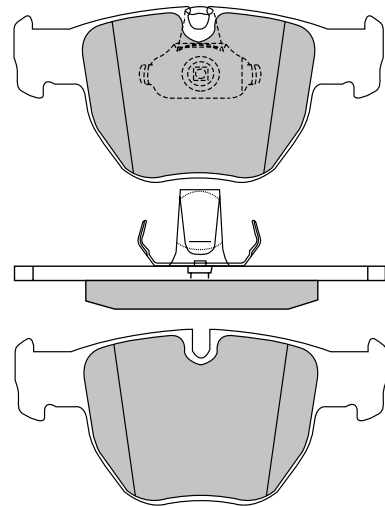
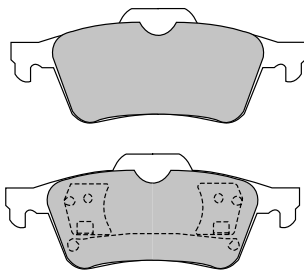

**ADB01153**

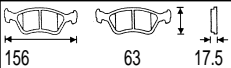

156 63 17.5

**WVA: 23440**

**FORD**

**ADB01157**

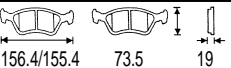

156.4/155.4 73.5 19

**WVA:**

**LAND ROVER**

Remarks: 2 plain pads, 2 pads with spring clips

Remarks: 2 plain pads, 2 pads with springs



# Disc Brake Pads Illustrations

**ANL  
Braking**

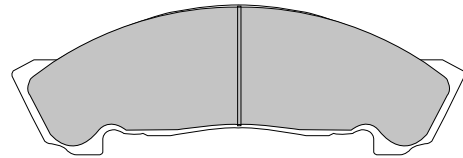
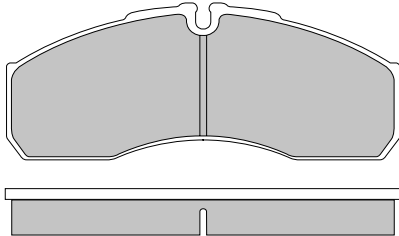

**ADB01173**

**IVECO**

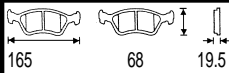

**WVA: 29160**

**ADB01175**

**ISUZU**

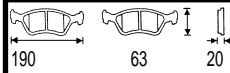

**WVA:**

Remarks: 4 identical pads

Remarks: 4 identical pads

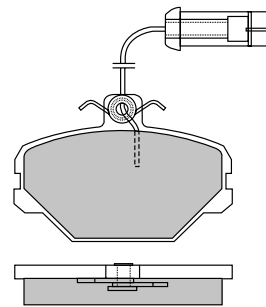
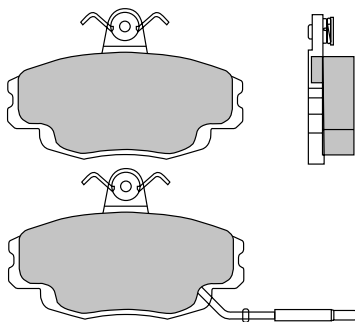

**ADB1133**

**RENAULT**

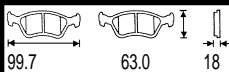

**WVA: 20937**

**ADB1142**

**FSO**

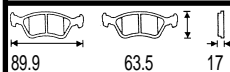

**WVA: 21100**

Remarks: 2 plain pads, 2 pads with wear indicators (handed) (200mm)

Remarks: 3 plain pads, 1 pad with wear indicator (255mm)



# Disc Brake Pads Illustrations

## ANL Braking

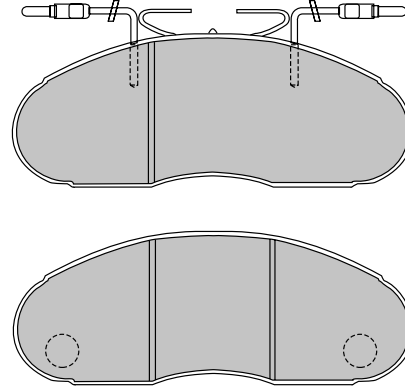
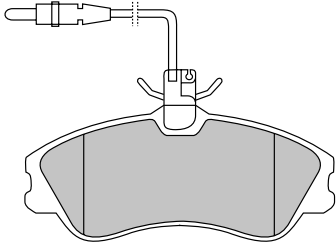

<b>ADB1174</b>
<b>WVA: 23124</b>

<b>CITROEN PEUGEOT</b>
----------------------------

<b>ADB1183</b>
<b>WVA: 29985</b>

<b>MERCEDES NISSAN RENAULT</b>
--

Remarks: 2 pairs of pads, 2 pairs of wear indicators (275mm, 310mm)

Remarks: 2 plain pads with 14mm plain holes, 2 pads with springs and wear indicators

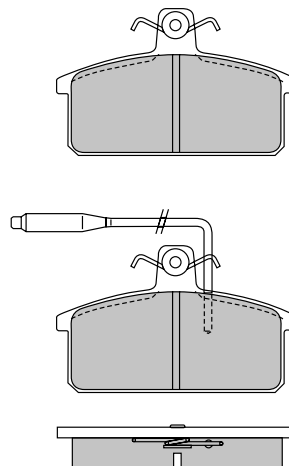
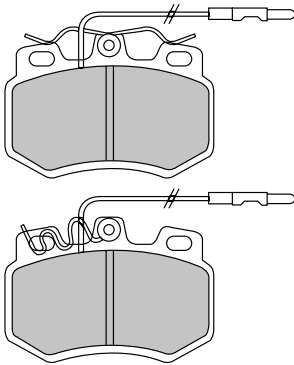

<b>ADB1191</b>
<b>WVA: 20989</b>

<b>CITROEN</b>
----------------

<b>ADB1204</b>
<b>WVA: 20708</b>

<b>SUZUKI</b>
---------------

Remarks: 2 pairs of pads with springs and wear indicators (handed) (320mm, 360mm)

Remarks: 2 plain pads, 2 pads with wear indicators (130mm)



# Disc Brake Pads Illustrations

**ANL  
Braking**

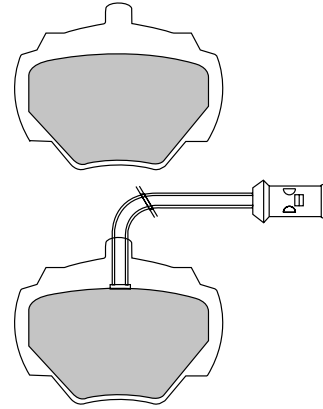
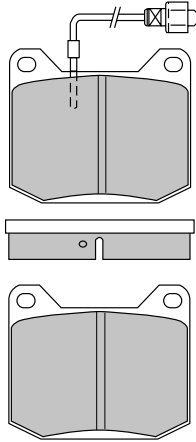

**ADB1205**

**PEUGEOT**

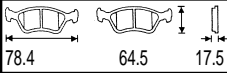

78.4 64.5 17.5

**WVA: 20145**

**ADB1224**

**LAND ROVER**

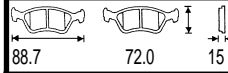

88.7 72.0 15

**WVA: 20344**

Remarks: 2 plain pads, 2 pads with wear indicators (65mm)

Remarks: 3 plain pads, 1 pad with wear indicator (210mm)

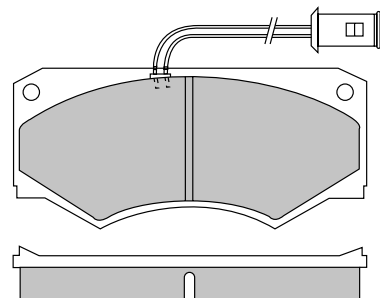
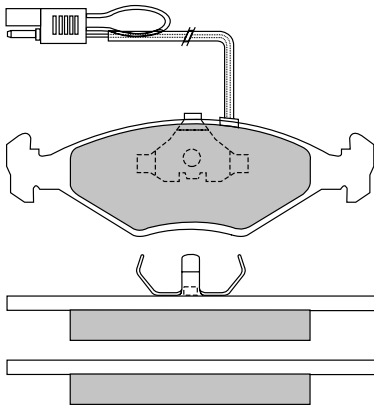

**ADB1228**

**FIAT**

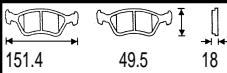

151.4 49.5 18

**WVA: 21195**

**ADB1235**

**IVECO  
TALBOT**

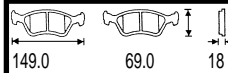

149.0 69.0 18

**WVA: 29040**

Remarks: 2 plain pads, 2 pads with spring clips and wear indicators (790mm)

Remarks: 2 plain pads, 2 pads with wear indicators (200mm)





# Disc Brake Pads Illustrations

**ANL  
Braking**

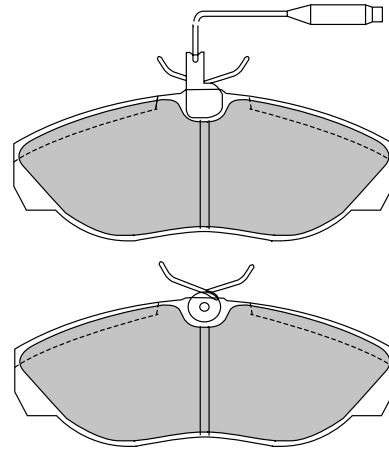
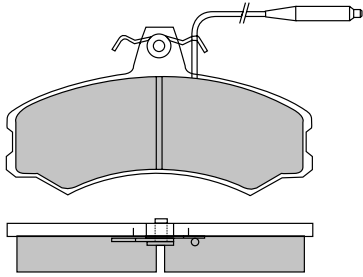

<b>ADB1254</b>	<b>ALFA ROMEO CITROEN FIAT IVECO PEUGEOT TALBOT</b>
<b>WVA: 20741</b>	

<b>ADB1275</b>	<b>CITROEN FIAT PEUGEOT</b>
<b>WVA: 21629</b>	

Remarks: 2 plain pads, 2 pads with wear indicators (120mm)

Remarks: 2 plain pads, 2 pads with wear indicators (200mm)

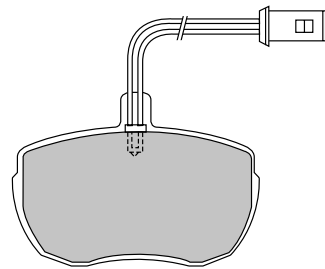
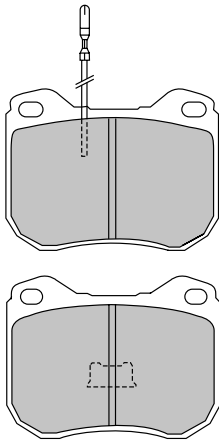

<b>ADB1308</b>	<b>PEUGEOT</b>
<b>WVA: 20455</b>	

<b>ADB1319</b>	<b>ALFA ROMEO IVECO</b>
<b>WVA: 21160</b>	

Remarks: 2 plain pads, 2 pads with wear indicators (80mm)

Remarks: 2 plain pads, 2 pads with wear indicators (150mm)



# Disc Brake Pads Illustrations

**ANL  
Braking**

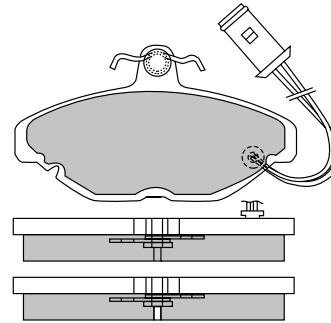
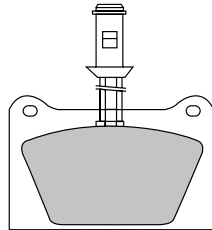

<b>ADB1392</b>
<b>WVA: 20754</b>

<b>ROVER</b>
--------------

<b>ADB1396</b>
<b>WVA: 21084</b>

<b>ROVER</b>
--------------

Remarks: 3 plain pads, 1 pad with wear indicator (152mm)

Remarks: 3 plain pads, 1 pad with wear indicator (210mm)

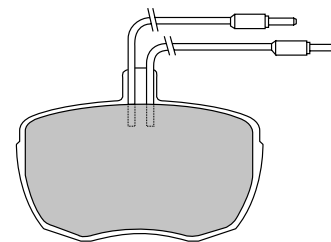
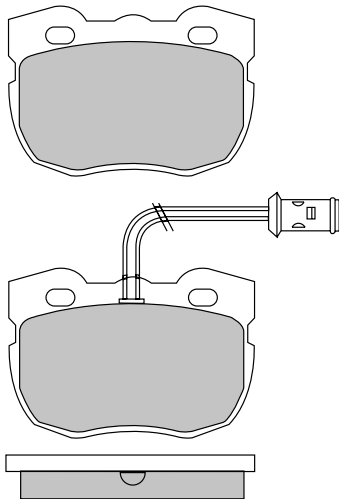

<b>ADB1401</b>
<b>WVA: 21459</b>

<b>TAXIS</b>
--------------

<b>ADB1412</b>
<b>WVA: 20359</b>

<b>ALFA ROMEO IVECO</b>
-----------------------------

Remarks: 3 plain pads, 1 pad with wear indicator (230mm)

Remarks: 2 plain pads, 2 pads with 2 wear indicators (150mm, 215mm)



# Disc Brake Pads Illustrations

**ANL  
Braking**

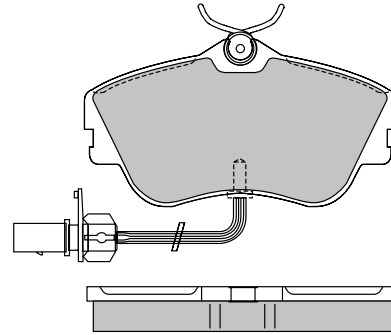
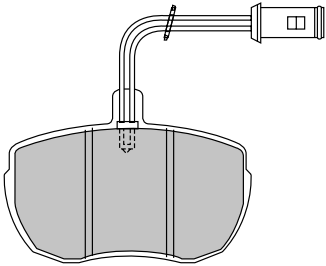

<b>ADB1413</b>	<b>LAND ROVER</b>
<b>WVA: 20359</b>	

<b>ADB1419</b>	<b>VOLKSWAGEN</b>
<b>WVA: 21479</b>	

Remarks: 3 plain pads, 1 pad with wear indicator

Remarks: 2 plain pads, 2 pads with wear indicators

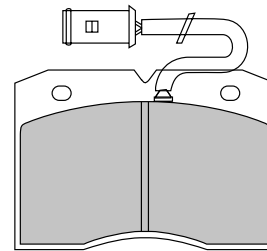
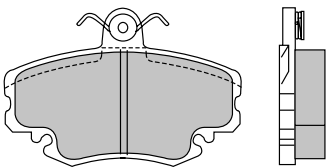

<b>ADB1431</b>	<b>RENAULT</b>
<b>WVA: 21463</b>	

<b>ADB1437</b>	<b>ALFA ROMEO IVECO</b>
<b>WVA: 29041</b>	

Remarks: 4 identical pads with 2 wear indicators supplied loose (215mm)

Remarks: 2 plain pads, 2 pads with wear indicators (170mm)



# Disc Brake Pads Illustrations

**ANL  
Braking**

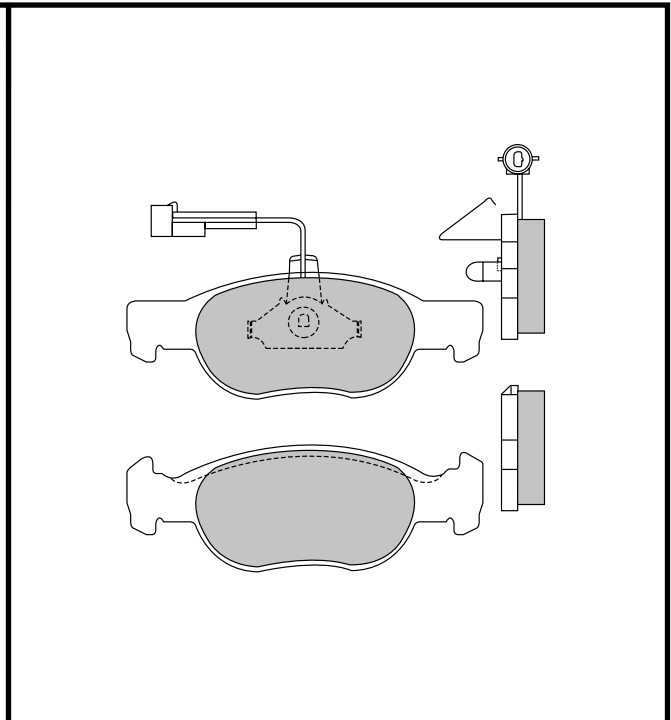
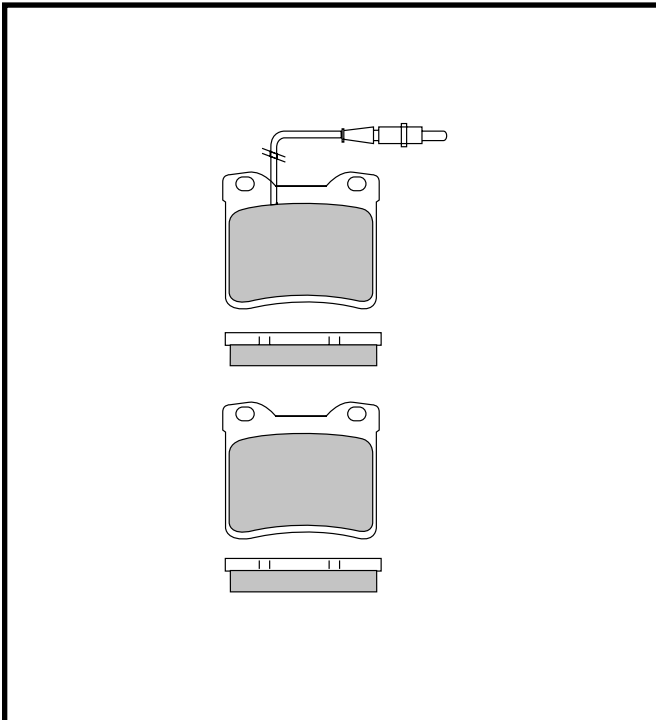

<b>ADB1455</b>	<b>MERCEDES</b>
<b>WVA: 21904</b>	

<b>ADB1479</b>	<b>FIAT</b>
<b>WVA: 21930</b>	

Remarks: 2 plain pads, 2 pads with wear indicators (110mm)

Remarks: 3 plain pads, 1 pad with wear indicator (200mm)

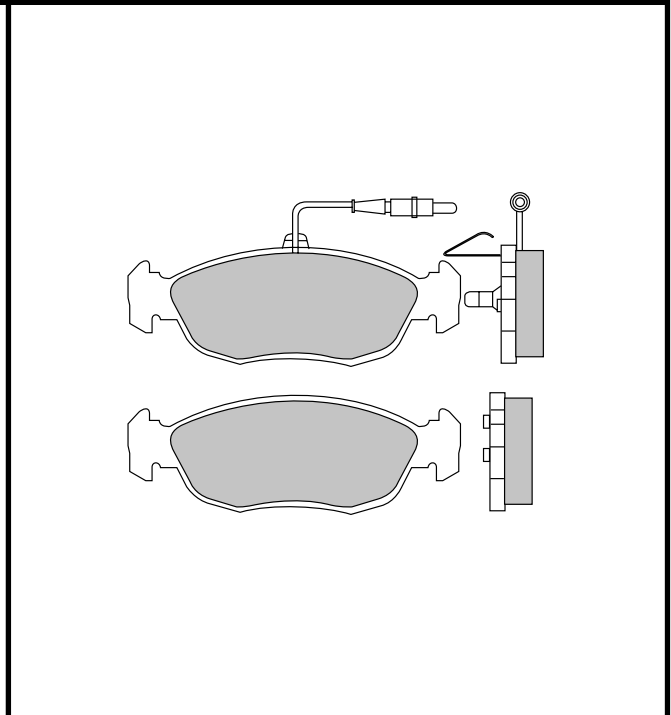
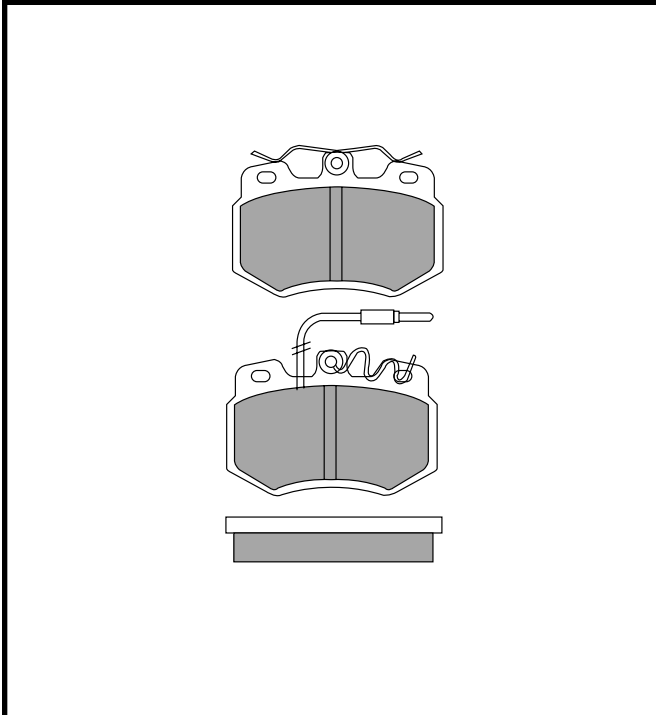

<b>ADB1515</b>	<b>PEUGEOT</b>
<b>WVA: 20988</b>	

<b>ADB1570</b>	<b>PEUGEOT</b>
<b>WVA: 21430</b>	

Remarks: 2 pads with springs, 2 pads with springs and wear indicators (handed) (205mm)

Remarks: 2 plain pads, 2 pads with spring clips and wear indicators (270mm)



# Disc Brake Pads Illustrations

## ANL Braking

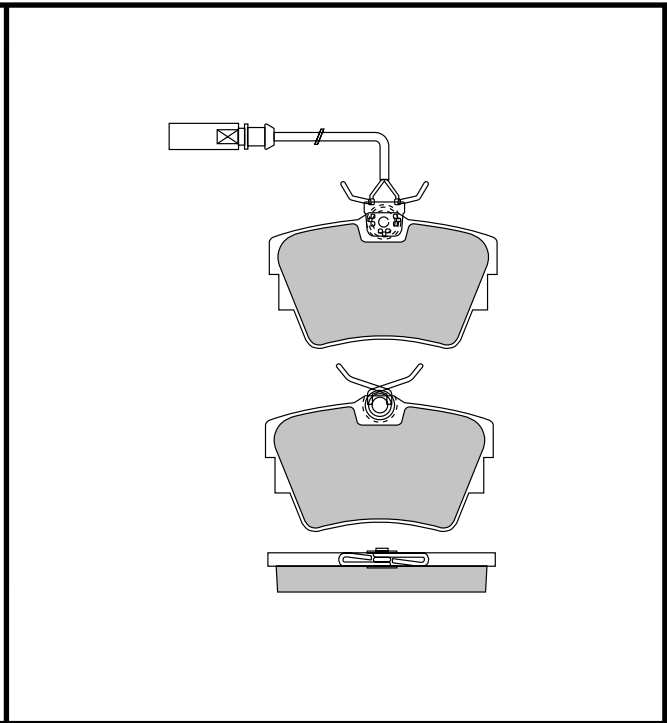
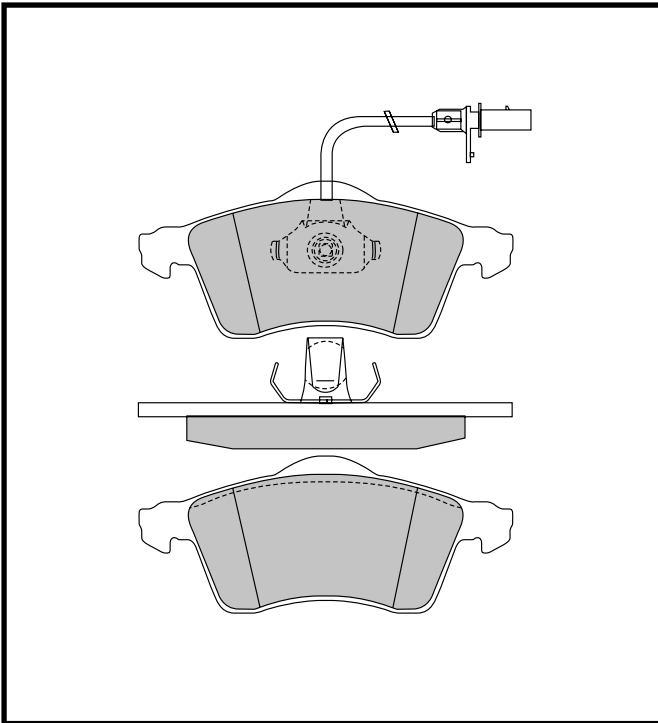

<b>ADB1852</b>	<b>VOLKSWAGEN</b>
 156.4    68.5    20	
<b>WVA: 21885</b>	

<b>ADB1874</b>	<b>VOLKSWAGEN</b>
 95.0    57.5    17	
<b>WVA: 23224</b>	

Remarks: 3 plain pads, 1 pad with wear indicator

Remarks: 2 plain pads, 2 pads with wear indicators

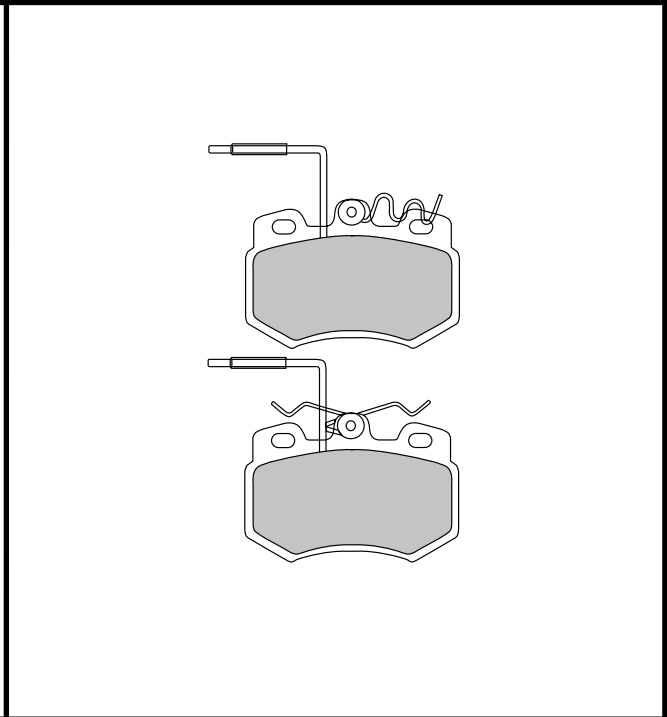
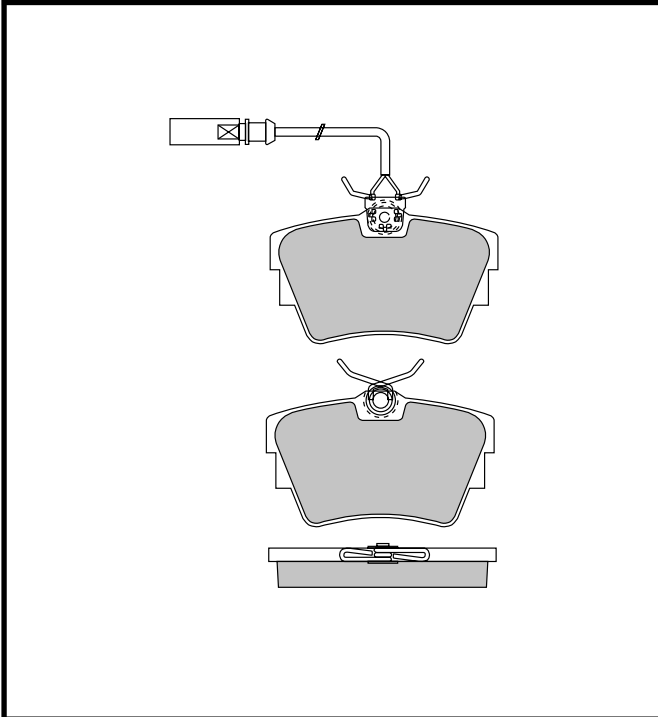

<b>ADB1907</b>	<b>VOLKSWAGEN</b>
 95    57.5    17	
<b>WVA:</b>	

<b>ADB1926</b>	<b>PEUGEOT</b>
 89.9    58.8    17.5	
<b>WVA: 21614</b>	

Remarks:

Remarks: 2 pairs of pads with springs and wear indicators (handed) (315mm, 355mm)



# Disc Brake Pads Illustrations

**ANL  
Braking**

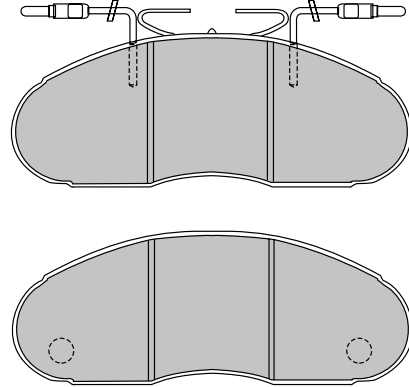
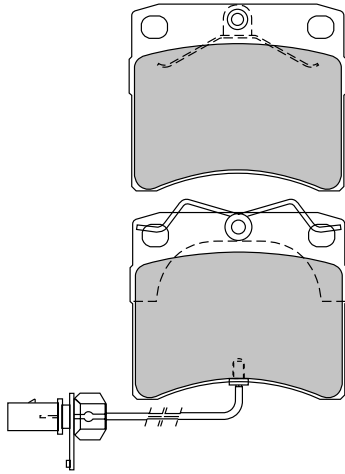

**ADB1953**

**VOLKSWAGEN**

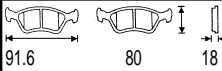

91.6 80 18

**WVA: 23176**

**ADB1991**

**MERCEDES  
NISSAN  
RENAULT**

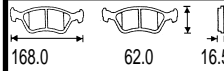

168.0 62.0 16.5

**WVA: 29984**

Remarks: 2 pads with springs, 2 pads with springs and wear indicators

Remarks: 2 plain pads with 10mm tapped holes, 2 pads with springs and wear indicators

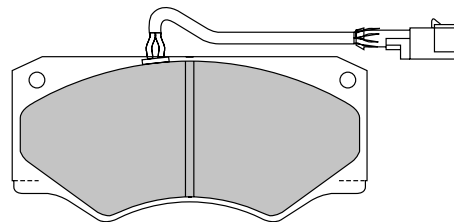
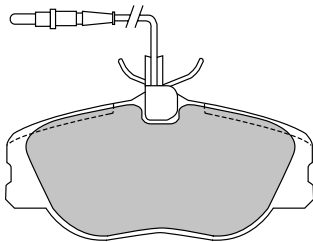

**ADB11001**

**CITROEN  
FIAT  
PEUGEOT**

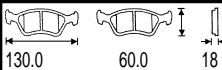

130.0 60.0 18

**WVA: 21801**

**ADB11028**

**IVECO**

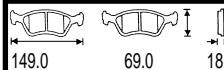

149.0 69.0 18

**WVA: 29138**

Remarks: 2 pairs of pads with wear indicators (185mm, 235mm)

Remarks: 2 plain pads, 2 pads with wear indicators



# Disc Brake Pads Illustrations

**ANL  
Braking**

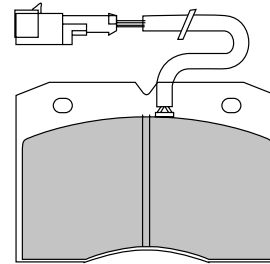
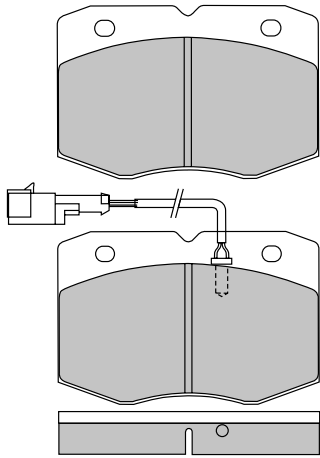

<b>ADB11029</b>		<b>IVECO</b>
<b>WVA: 29139</b>		

<b>ADB11030</b>		<b>IVECO</b>
<b>WVA: 29140</b>		

Remarks: 2 plain pads, 2 pads with wear indicators

Remarks: 2 plain pads, 2 pads with wear indicators

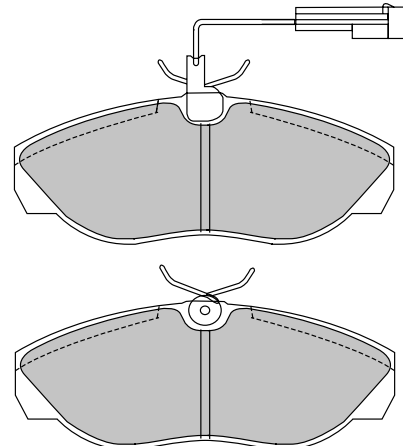
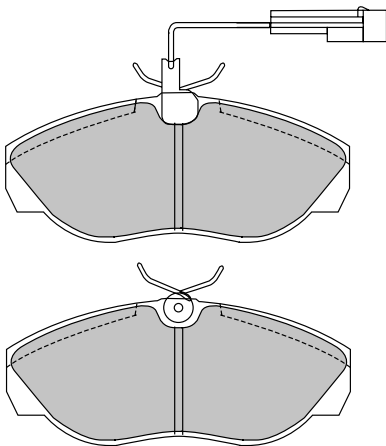

<b>ADB11031</b>		<b>FIAT</b>
<b>WVA: 23602</b>		

<b>ADB11032</b>		<b>FIAT</b>
<b>WVA: 23603</b>		

Remarks: 3 plain pads, 1 pad with wear indicator (300mm)

Remarks: 3 plain pads, 1 pad with wear indicator (300mm)



# Disc Brake Pads Illustrations

**ANL  
Braking**

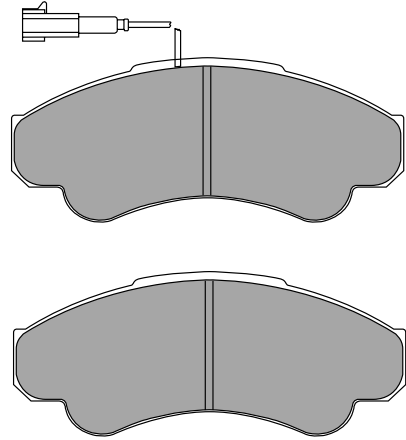
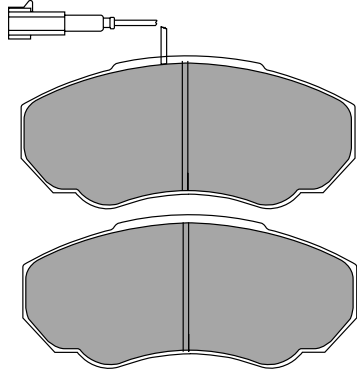

**ADB11040**

**CITROEN  
FIAT  
PEUGEOT**

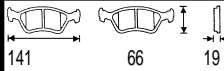

**WVA: 23602**

**ADB11041**

**CITROEN  
FIAT  
PEUGEOT**

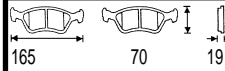

**WVA: 23603**

Remarks: 3 plain pads, 1 pad with wear indicator

Remarks: 3 plain pads, 1 pad with wear indicator

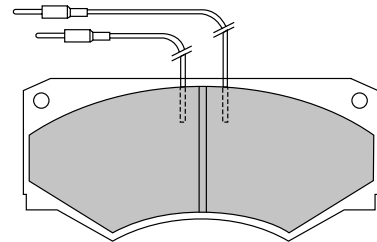
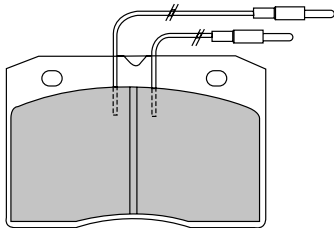

**ADB11047**

**ALFA ROMEO  
FIAT  
IVECO**

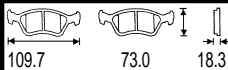

**WVA: 21049**

**ADB11051**

**IVECO**

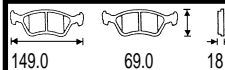

**WVA: 21006**

Remarks: 2 plain pads, 2 pads with 2 wear indicators (120mm, 160mm)

Remarks: 2 plain pads, 2 pads with 2 wear indicators (200mm)





# Disc Brake Pads Illustrations

## ANL Braking

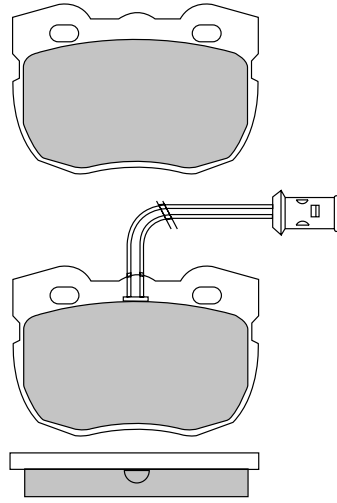
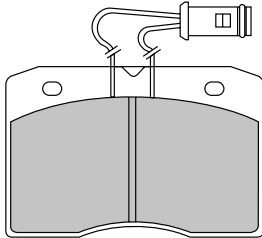

<b>ADB11054</b>
<b>WVA: 21188</b>

<b>ALFA ROMEO IVECO</b>
-----------------------------

<b>ADB11055</b>
<b>WVA: 21459</b>

<b>LAND ROVER</b>
-------------------

Remarks: 2 plain pads, 2 pads with wear indicators (170mm)

Remarks: 2 plain pads, 2 pads with wear indicators

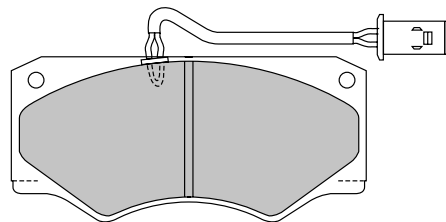
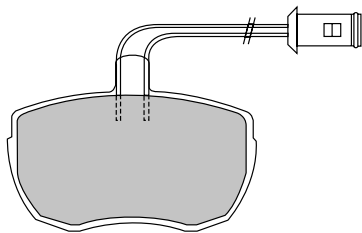

<b>ADB11059</b>
<b>WVA: 20359</b>

<b>ALFA ROMEO IVECO</b>
-----------------------------

<b>ADB11068</b>
<b>WVA: 29012</b>

<b>IVECO</b>
--------------

Remarks: 2 plain pads, 2 pads with wear indicators (150mm)

Remarks: 2 plain pads, 2 pads with wear indicators



# Disc Brake Pads Illustrations

**ANL  
Braking**

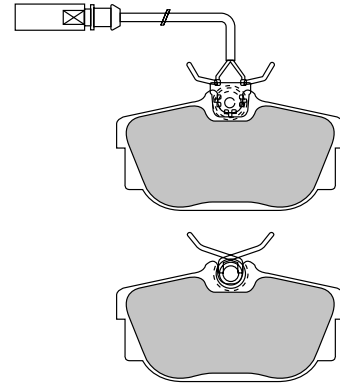
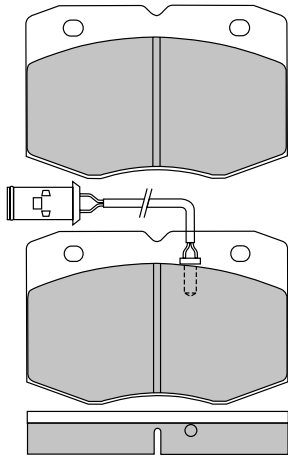

**ADB11069**

**ALFA ROMEO  
IVECO**

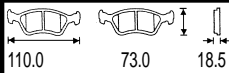

**WVA: 29037**

**ADB11151**

**VOLKSWAGEN**

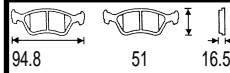

**WVA: 23446**

Remarks: 2 plain pads, 2 pads with wear indicators (150mm)

Remarks: 3 plain pads, 1 pad with wear indicator

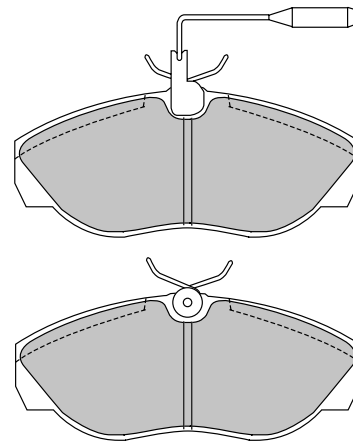
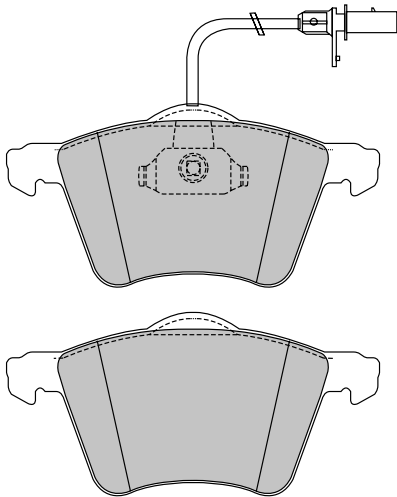

**ADB11168**

**VOLKSWAGEN**

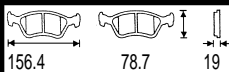

**WVA: 23034**

**ADB2219**

**CITROEN  
FIAT  
PEUGEOT**

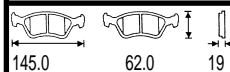

**WVA: 21627**

Remarks: 2 plain pads, 2 pads with wear indicators (210mm)

Remarks: 2 plain pads, 2 pads with wear indicators (200mm)



# Disc Brake Pads Illustrations

## ANL Braking

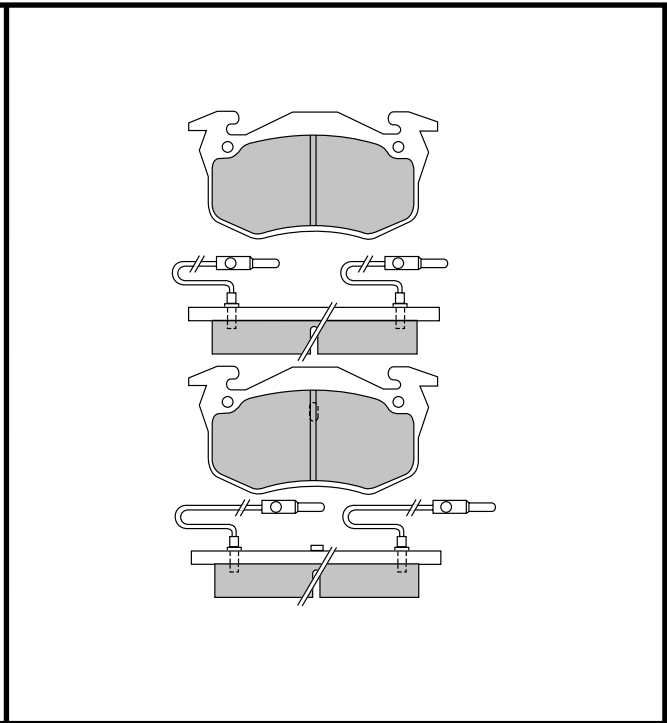
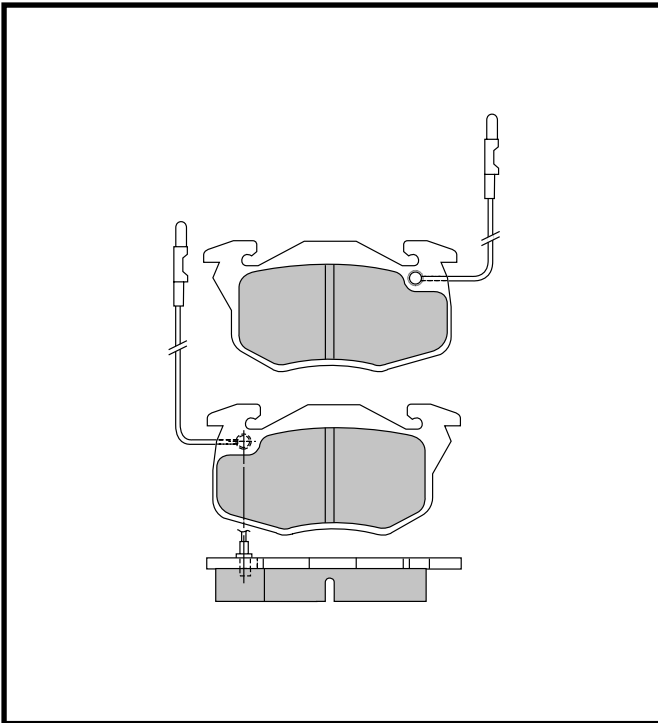

<b>ADB2258</b>	<b>PEUGEOT RENAULT</b>
 105.0    54.0    18	
<b>WVA: 20905</b>	

<b>ADB2310</b>	<b>CITROEN</b>
 105.0    54.5    18	
<b>WVA: 20635</b>	

Remarks: 2 plain pads (handed), 2 pads (handed) with wear indicators supplied loose (205mm)    Remarks: 2 pairs of pads, 2 pairs of wear indicators supplied loose (135mm, 245mm)

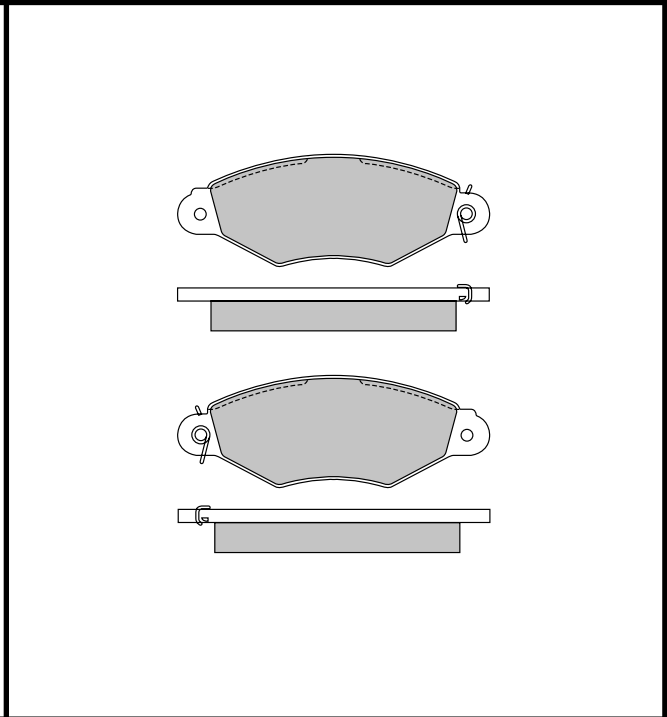
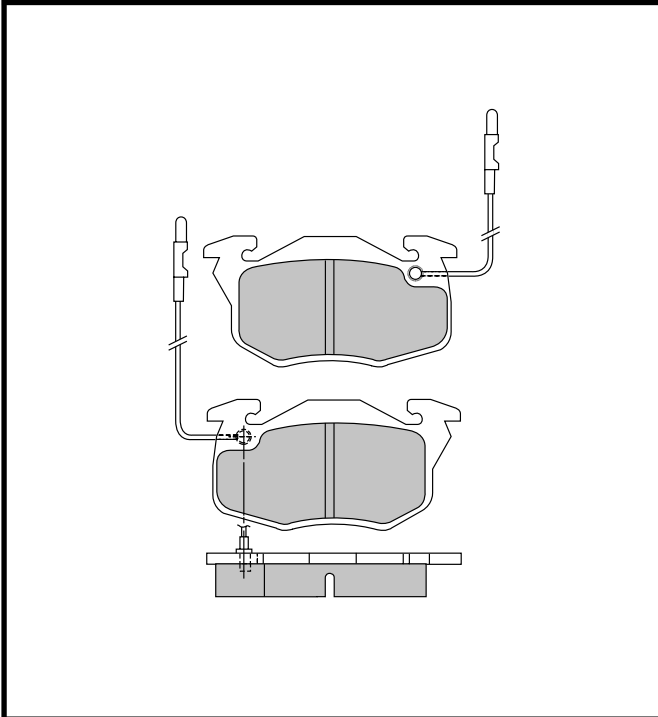

<b>ADB2416</b>	<b>PEUGEOT</b>
 105.0    54.0    18	
<b>WVA: 21061</b>	

<b>ADB2485</b>	<b>RENAULT</b>
 130.8    47.4    17.3	
<b>WVA: 21978</b>	

Remarks: 2 pairs of pads (handed), with two pairs of wear indicators supplied loose (285mm, 368mm)    Remarks: 2 pairs of pads with springs



# Disc Brake Pads Illustrations

**ANL  
Braking**

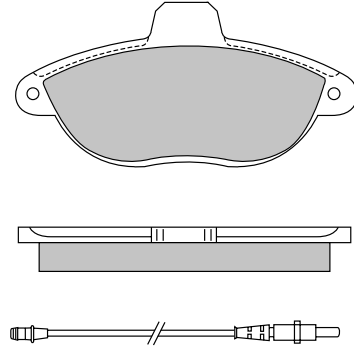
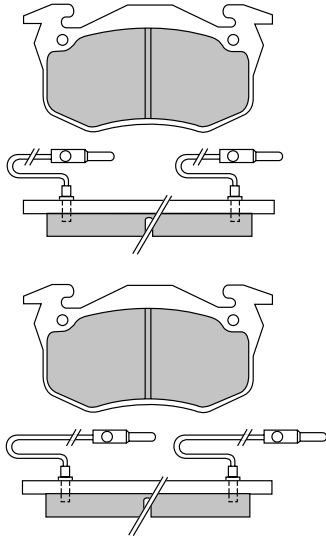

**ADB2533**

**RENAULT**

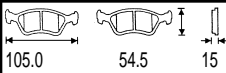

**WVA: 21096**

**ADB2714**

**CITROEN  
FIAT  
PEUGEOT**

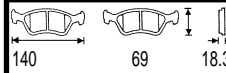

**WVA: 23003**

Remarks: 4 identical pads with 2 wear indicators supplied loose (208mm)

Remarks: 2 plain pads, 2 pads with wear indicators (270mm)

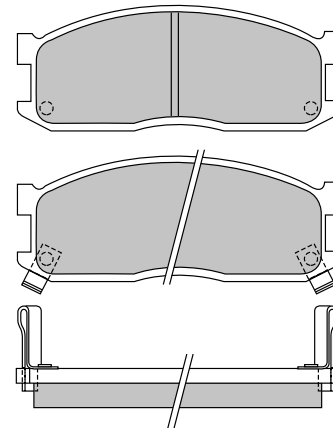
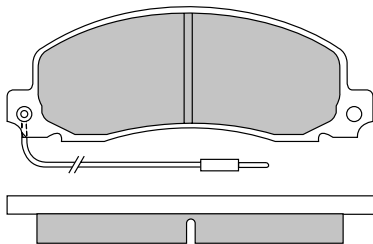

**ADB21048**

**RENAULT  
VAUXHALL**

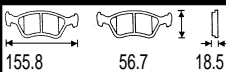

**WVA: 20926**

**ADB3168**

**KIA  
MAZDA**

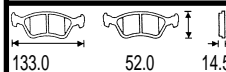

**WVA: 20002**

Remarks: 2 plain pads (handed), 2 pads with W.I (handed) supplied loose (320mm)

Remarks: 2 plain pads, 2 pads with spring wear indicators (handed)



# Disc Brake Pads Illustrations

## ANL Braking

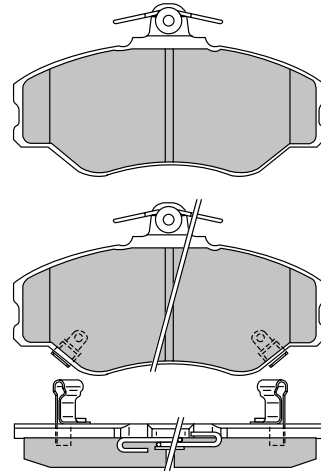
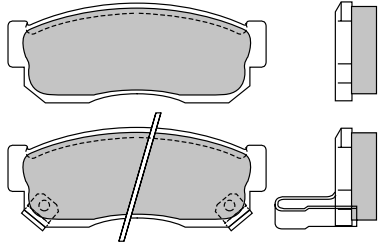

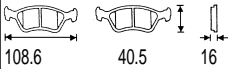
<b>ADB3207</b>

<b>WVA: 21224</b>

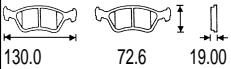
<b>NISSAN SUBARU</b>
--------------------------

<b>ADB3225</b>

<b>WVA: 23083</b>

<b>HYUNDAI</b>
----------------

Remarks: 2 plain pads, 2 pads with spring wear indicators (handed)

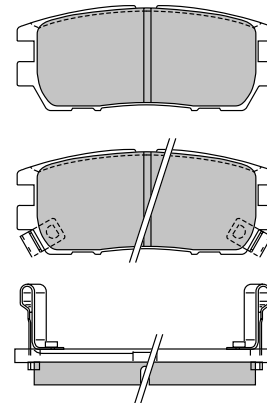
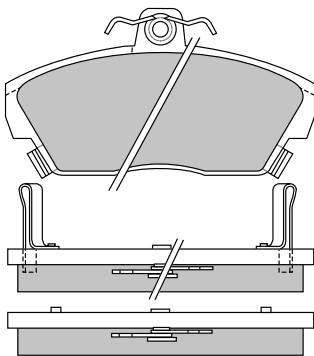
Remarks: 2 plain pads, 2 pads with spring wear indicators (handed)

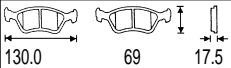

<b>ADB3232</b>

<b>WVA: 21515</b>

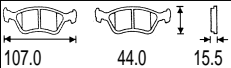
<b>LAND ROVER</b>
-------------------

<b>ADB3233</b>

<b>WVA: 21842</b>

<b>MITSUBISHI</b>
-------------------

Remarks: 2 plain pads, 2 pads with spring wear indicators (handed)

Remarks: 2 plain pads, 2 pads with spring wear indicators (handed)



# Disc Brake Pads Illustrations

**ANL  
Braking**

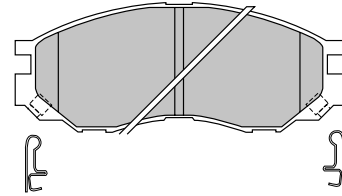
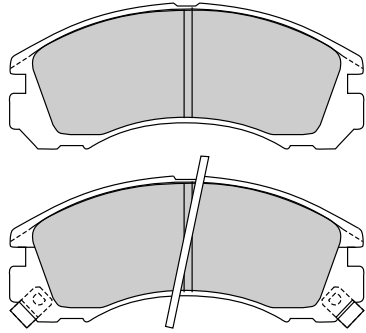

**ADB3234**

**MITSUBISHI**

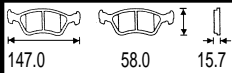

**WVA: 21769**

**ADB3269**

**MITSUBISHI**

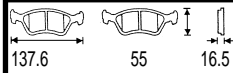

**WVA: 23290**

Remarks: 2 plain pads, 2 pads with spring wear indicators (handed)

Remarks: 2 plain pads, 2 pads with spring W.I.-handed supplied loose

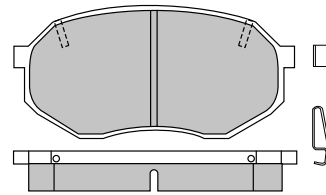
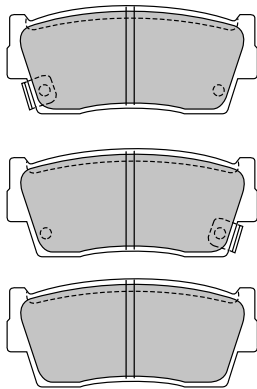

**ADB3273**

**SUZUKI**

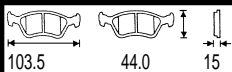

**WVA: 21502**

**ADB3285**

**MITSUBISHI**

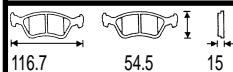

**WVA: 20892**

Remarks: 2 plain pads, 2 pads with spring wear indicators (handed)

Remarks: 4 identical pads with 4 spring wear indicators supplied loose



# Disc Brake Pads Illustrations

## ANL Braking

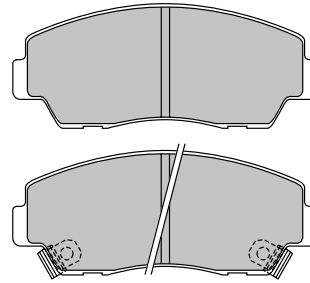
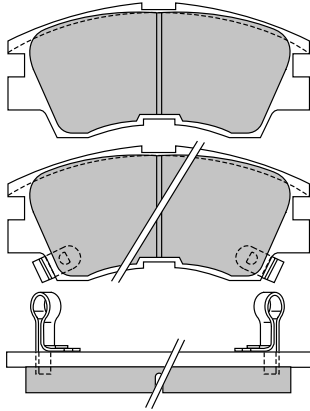

<b>ADB3295</b>	<b>MITSUBISHI</b>
<b>WVA: 21373</b>	

<b>ADB3320</b>	<b>MAZDA</b>
<b>WVA:</b>	

Remarks: 2 plain pads, 2 pads with spring wear indicators (handed)

Remarks: 2 plain pads, 2 pads with spring wear indicators (handed)

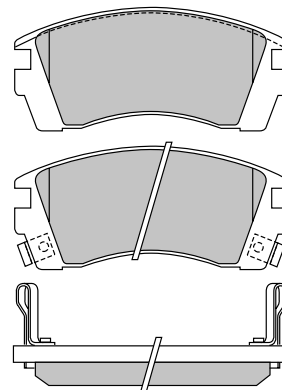
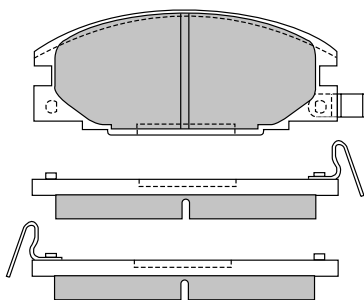

<b>ADB3322</b>	<b>ISUZU VAUXHALL</b>
<b>WVA: 21544</b>	

<b>ADB3330</b>	<b>NISSAN</b>
<b>WVA: 21718</b>	

Remarks: 2 pairs of pads with spring wear indicators (handed)

Remarks: 4 identical pads with 2 spring wear indicators supplied loose



# Disc Brake Pads Illustrations

**ANL  
Braking**

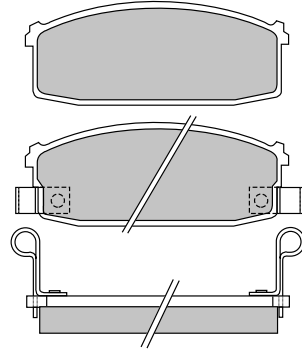
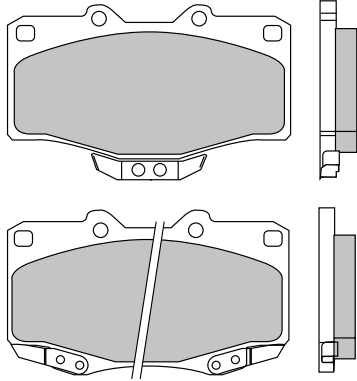

**ADB3333**

**TOYOTA  
VOLKSWAGEN**

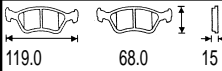

**WVA: 21680**

**ADB3368**

**NISSAN**

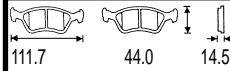

**WVA: 20718**

Remarks: 2 pads with spring wear indicators , 2 pads with spring wear indicators (handed)

Remarks: 2 plain pads, 2 pads with spring wear indicators (handed)

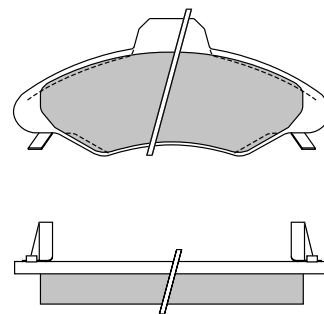
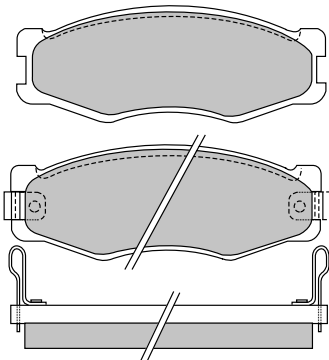

**ADB3387**

**L.D.V  
NISSAN**

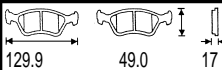

**WVA: 21119**

**ADB3393**

**FORD**

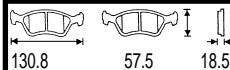

**WVA: 23300**

Remarks: 2 plain pads, 2 pads with spring wear indicators (handed)

Remarks: 2 plain pads, 2 pads with spring clips





# Disc Brake Pads Illustrations

## ANL Braking

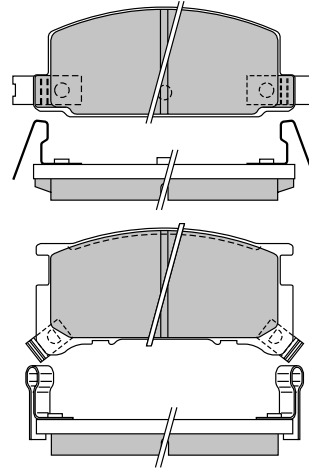
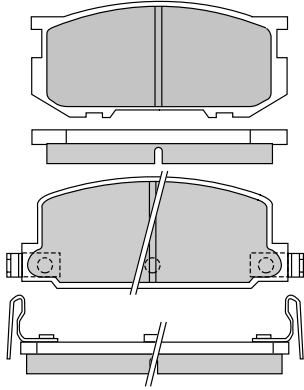

<b>ADB3399</b>	<b>SUBARU</b>
<b>WVA: 20766</b>	

<b>ADB3400</b>	<b>SUBARU</b>
<b>WVA: 20767</b>	

Remarks: 2 pairs of pads, 2 pads with spring wear indicators (handed)

Remarks: 2 pairs of pads with spring wear indicators (handed)

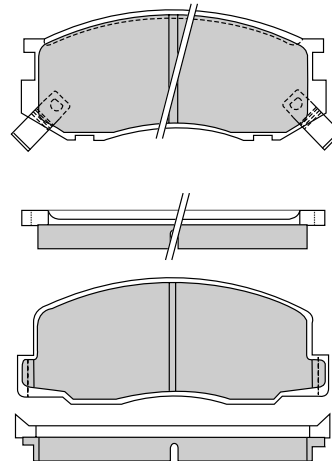
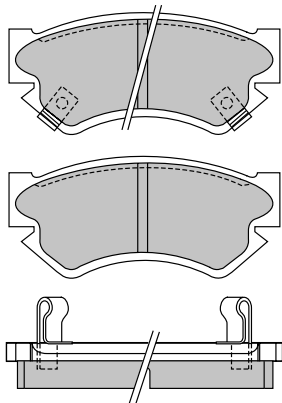

<b>ADB3402</b>	<b>SUBARU</b>
<b>WVA: 21549</b>	

<b>ADB3422</b>	<b>TOYOTA</b>
<b>WVA: 20182</b>	

Remarks: 2 plain pads, 2 pads with spring wear indicators (handed)

Remarks: 2 plain pads, 2 pads with spring wear indicators (handed)



# Disc Brake Pads Illustrations

**ANL  
Braking**

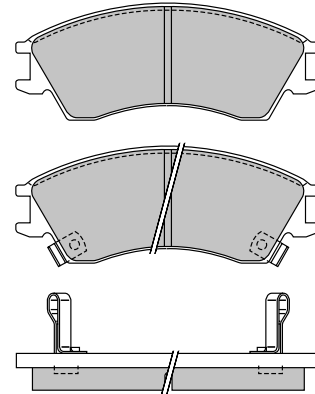
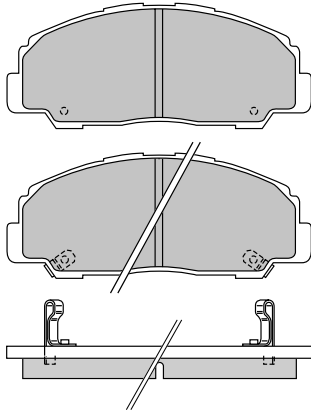

**ADB3439**

**DAIHATSU**

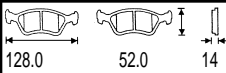

128.0 52.0 14

**WVA: 21967**

**ADB3451**

**SUBARU**

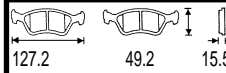

127.2 49.2 15.5

**WVA: 21709**

Remarks: 2 plain pads, 2 pads with spring wear indicators (handed)

Remarks: 2 plain pads, 2 pads with spring wear indicators (handed)

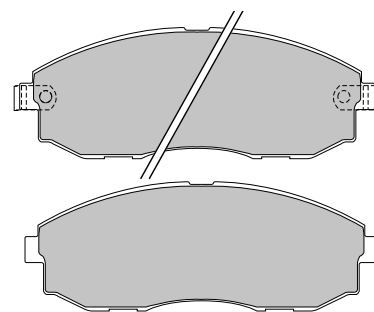
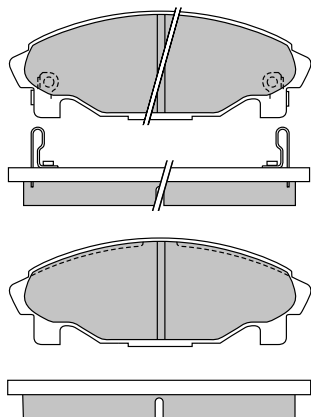

**ADB3457**

**DAIHATSU**

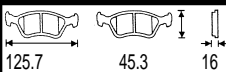

125.7 45.3 16

**WVA: 21952**

**ADB3481**

**HYUNDAI**

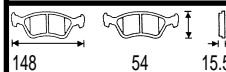

148 54 15.5

**WVA: 23536**

Remarks: 2 plain pads, 2 pads with spring wear indicators (handed)

Remarks: 2 plain pads, 2 pads with spring wear indicators (handed)



# Disc Brake Pads Illustrations

**ANL  
Braking**

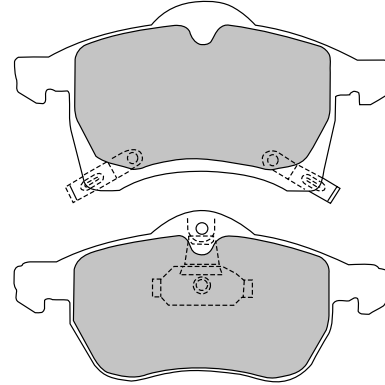
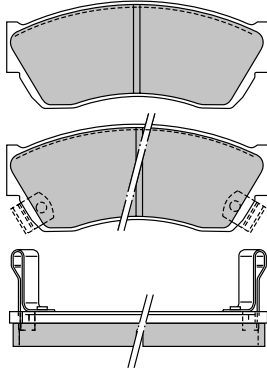

<b>ADB3518</b>	<b>SUBARU</b>
<b>WVA: 21333</b>	

<b>ADB3583</b>	<b>OPEL VAUXHALL</b>
<b>WVA: 23116</b>	

Remarks: 2 plain pads, 2 pads with spring wear indicators (handed)

Remarks: 2 pads with springs, 2 pads with spring wear indicators (handed)

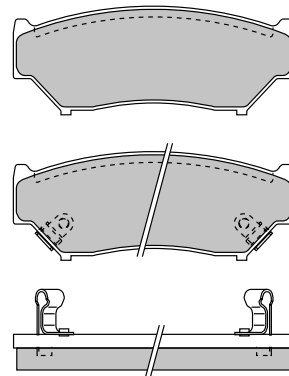
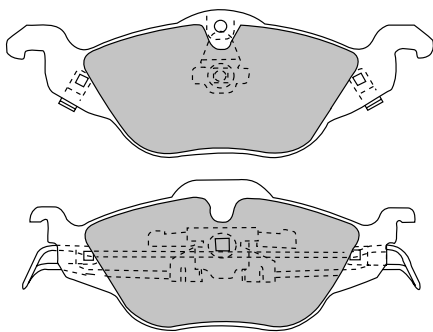

<b>ADB3584</b>	<b>OPEL VAUXHALL</b>
<b>WVA: 23063</b>	

<b>ADB3587</b>	<b>SUZUKI</b>
<b>WVA: 21907</b>	

Remarks: 2 pads with springs, 2 pads with spring wear indicators (handed)

Remarks: 2 plain pads, 2 pads with spring wear indicators (handed)



# Disc Brake Pads Illustrations

**ANL  
Braking**

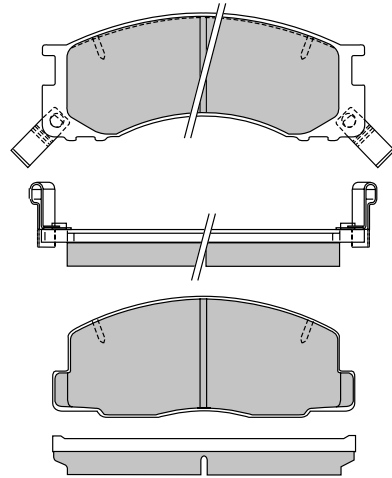
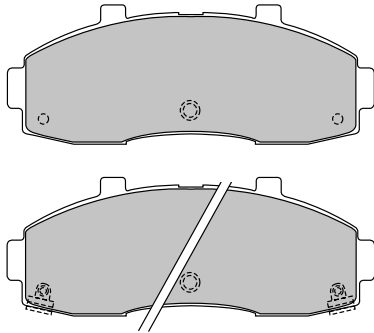

**ADB3721**

**KIA**

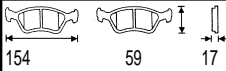

**WVA: 23484**

**ADB3746**

**TOYOTA**

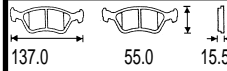

**WVA: 21837**

Remarks: 2 plain pads, 2 pads with spring wear indicators (handed)

Remarks: 2 plain pads, 2 pads with spring wear indicators (handed)

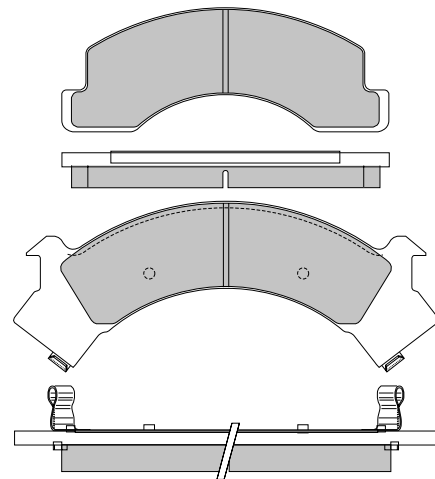
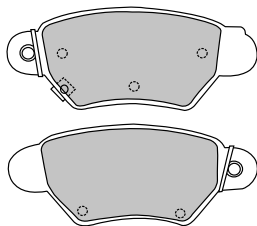

**ADB3750**

**OPEL  
VAUXHALL**

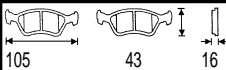

**WVA: 23258**

**ADB3812**

**ISUZU**

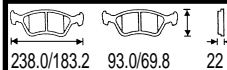

**WVA:**

Remarks: 2 pads with springs, 2 pads with spring wear indicators (handed)

Remarks: 2 plain pads, 2 pads with spring wear indicators (handed)



# Disc Brake Pads Illustrations

**ANL  
Braking**

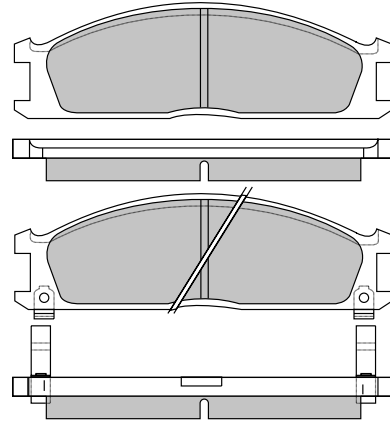
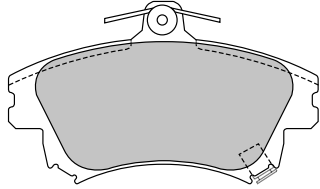

<b>ADB3813</b>	<b>PROTON</b>
<b>WVA: 21983</b>	

<b>ADB3863</b>	<b>FORD NISSAN</b>
<b>WVA: 21348</b>	

Remarks: 2 plain pads, 2 pads with spring W.I.-handed supplied loose

Remarks: 2 plain pads, 2 pads with spring wear indicators (handed)

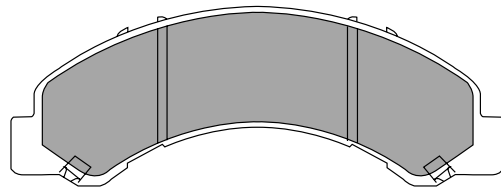
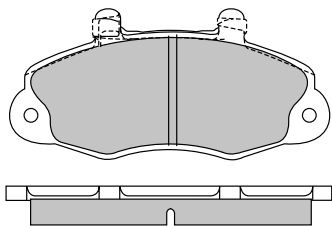

<b>ADB3887</b>	<b>FORD</b>
<b>WVA: 21470</b>	

<b>ADB3918</b>	<b>ISUZU</b>
<b>WVA:</b>	

Remarks: 4 identical pads with 2 spring wear indicators supplied loose

Remarks: 4 identical pads



# Disc Brake Pads Illustrations

**ANL  
Braking**

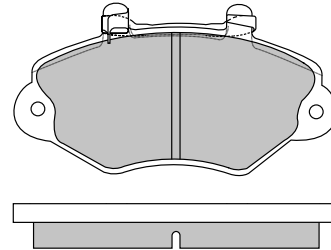
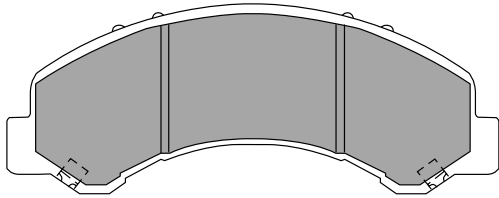

<b>ADB3919</b>	<b>ISUZU</b>
<b>WVA:</b>	

<b>ADB3924</b>	<b>FORD</b>
<b>WVA: 21469</b>	

Remarks: 4 identical pads

Remarks: 4 identical pads with 2 spring wear indicators supplied loose

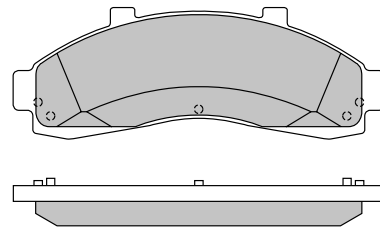
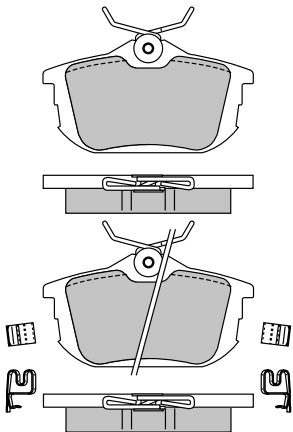

<b>ADB3945</b>	<b>PROTON</b>
<b>WVA: 21861</b>	

<b>ADB31014</b>	<b>FORD</b>
<b>WVA: 23472</b>	

Remarks: 4 identical pads

Remarks: 2 plain pads, 2 pads with spring wear indicators (handed)



# Disc Brake Pads Illustrations

## ANL Braking

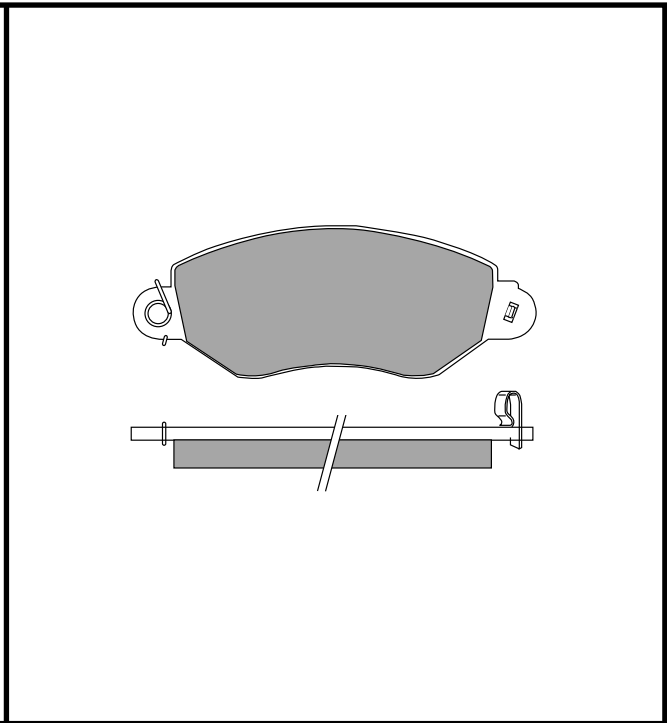
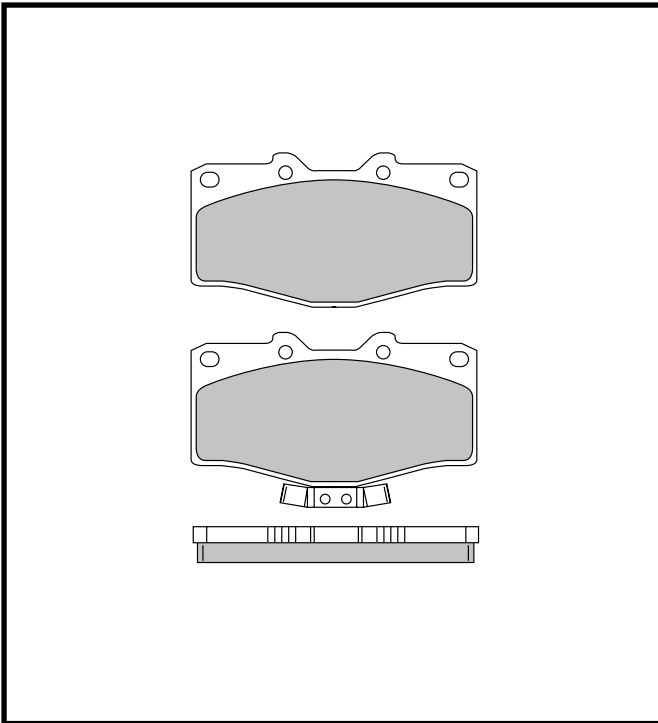

<b>ADB31090</b>	<b>TOYOTA</b>
<b>WVA: 21784</b>	

<b>ADB31107</b>	<b>FORD</b>
<b>WVA: 23434</b>	

Remarks: 2 plain pads, 2 pads with spring wear indicators

Remarks: 2 pairs of pads, 2 pads with spring wear indicators

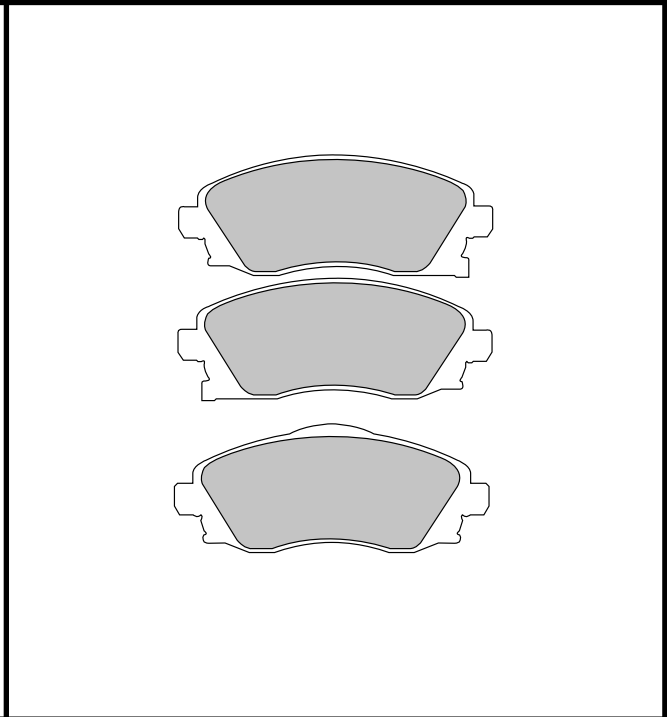
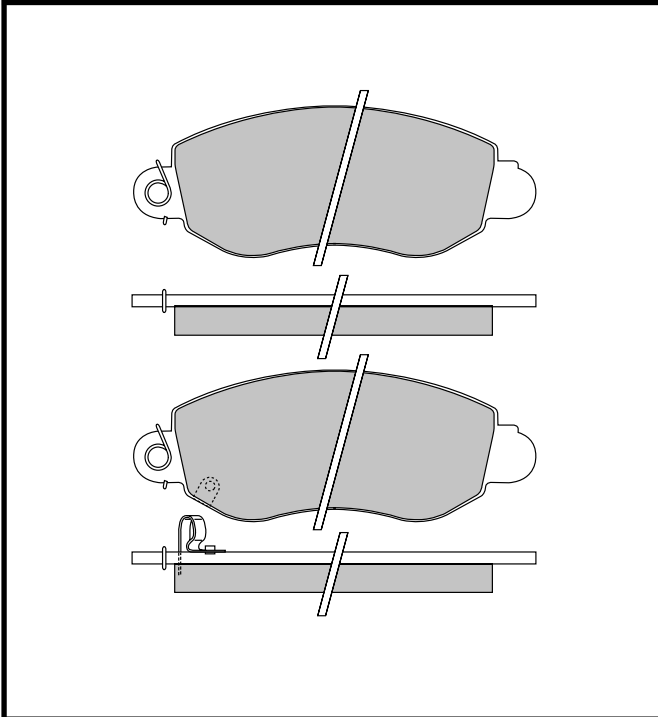

<b>ADB31108</b>	<b>FORD</b>
<b>WVA: 23577</b>	

<b>ADB31112</b>	<b>OPEL VAUXHALL</b>
<b>WVA: 23225</b>	

Remarks: 2 pads with springs (handed), 2 pads with springs & spring wear indicators (handed)

Remarks: 2 plain pads, 2 pads with spring wear indicators (handed)



# Disc Brake Pads Illustrations

**ANL  
Braking**

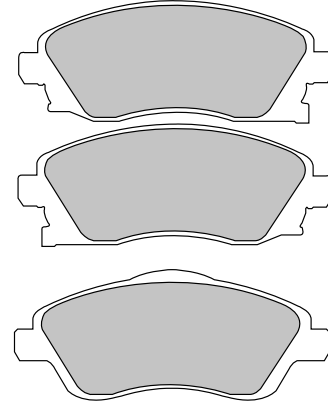
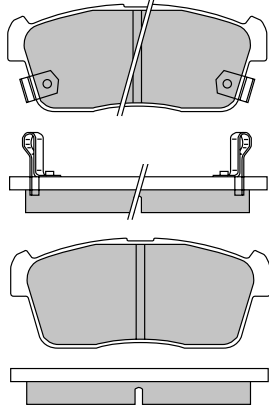

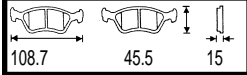
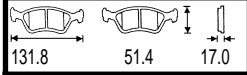
<b>ADB31113</b>	<b>SUZUKI</b>	<b>ADB31161</b>	<b>OPEL VAUXHALL</b>
			
<b>WVA: 23507</b>		<b>WVA:</b>	

Remarks: 2 plain pads, 2 pads with spring wear indicators (handed)      Remarks: 2 plain pads, 2 pads with spring wear indicators (handed)

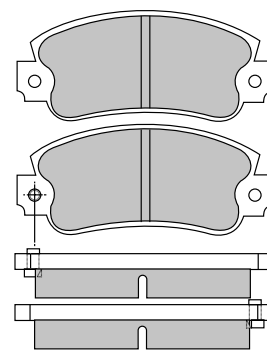
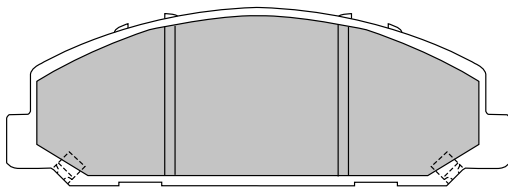

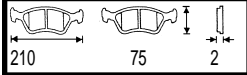
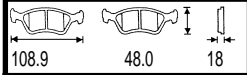
<b>ADB31174</b>	<b>ISUZU</b>	<b>ADB4129</b>	<b>FIAT SEAT</b>
			
<b>WVA:</b>		<b>WVA: 20950</b>	

Remarks:      Remarks: 2 plain pads, 2 pads with wear indicators plugs (handed)





# Disc Brake Pads Illustrations

## ANL Braking

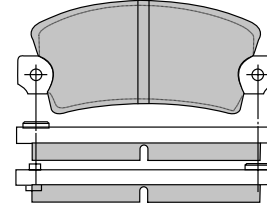
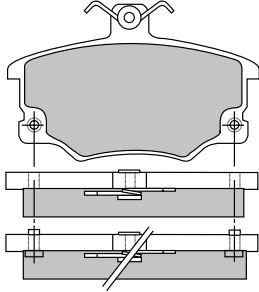

<b>ADB4137</b>	<b>FIAT</b>
<b>WVA: 20833</b>	

<b>ADB4311</b>	<b>RENAULT</b>
<b>WVA: 20347</b>	

Remarks: 2 plain pads, 2 pads with wear indicators plugs (handed)

Remarks: 2 pads (handed), 2 pads with wear indicator plugs (handed)

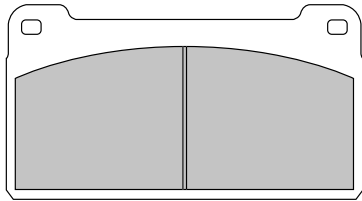

<b>OTR162</b>	<b>MERCEDES</b>
<b>WVA: 29324</b>	



Remarks: 1 single pad



## Wear Lead Illustrations

SECTION

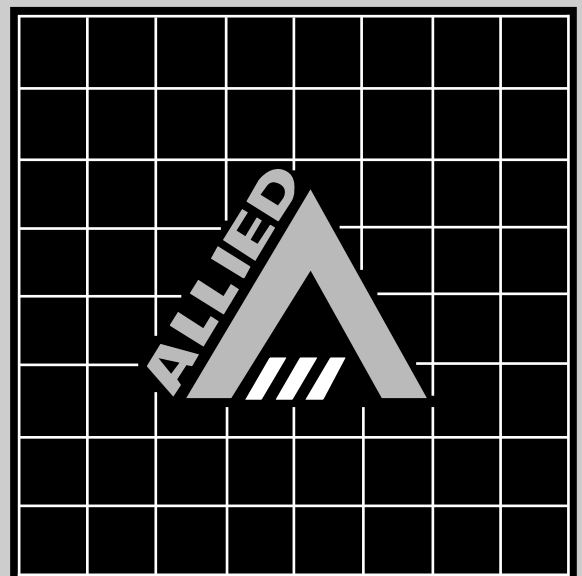
D





# Wear Indicator Illustrations

ANL  
Braking

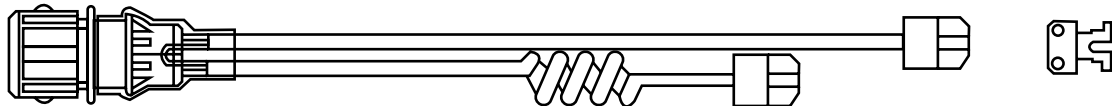

**WL001**

HEULIEZ, RENAULT, VAN HOOL, VOLVO

2 × 355mm

Fits Parts Nos: ACV014, ACV029, ACV030

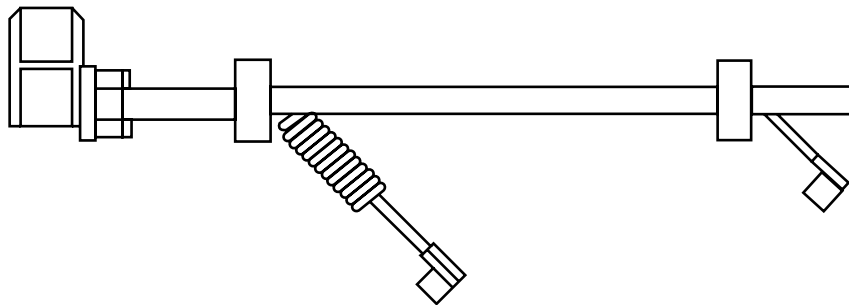

**WL002**

DENNIS, RENAULT, VAN HOOL

2 × 280mm

Fits Parts Nos: ACV014, ACV029, ACV030

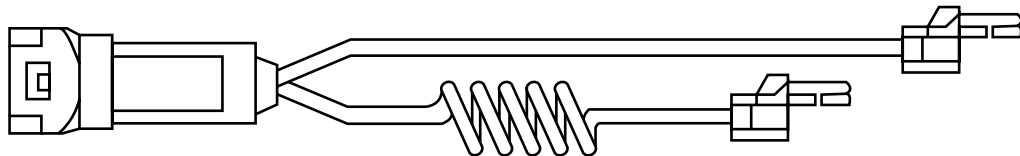

**WL003**

DENNIS, ERF, KASSBOHRER, MAN

2 × 340mm

Fits Parts Nos: ACV014, ACV030

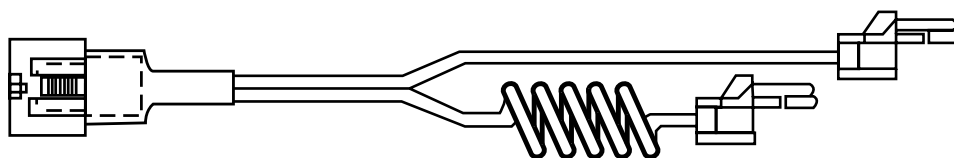

**WL004**

HEULIEZ, KAROSA, KASSBOHRER, RENAULT

2 × 365mm

Fits Parts Nos: ACV014, ACV030



# Wear Indicator Illustrations

**ANL  
Braking**

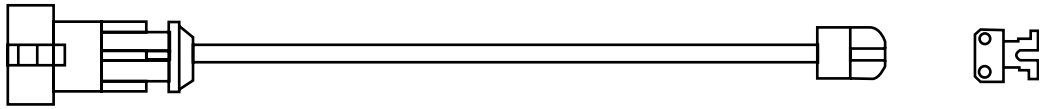

**WL005**

IVECO

2 × 495mm

Fits Parts Nos: ACV032

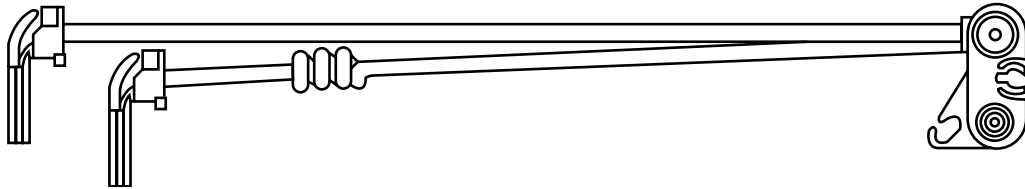

**WL006**

IVECO

2 × 270mm

Fits Parts Nos: ACV041

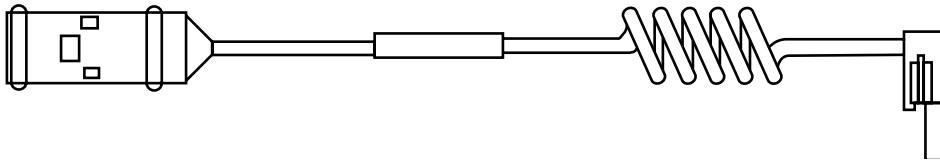

**WL007**

IVECO

2 × 405mm

Fits Parts Nos: ACV016, ACV017

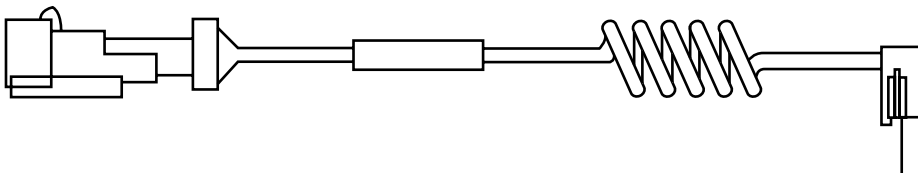

**WL008**

IVECO

2 × 430mm

Fits Parts Nos: ACV016, ACV017



# Wear Indicator Illustrations

ANL  
Braking

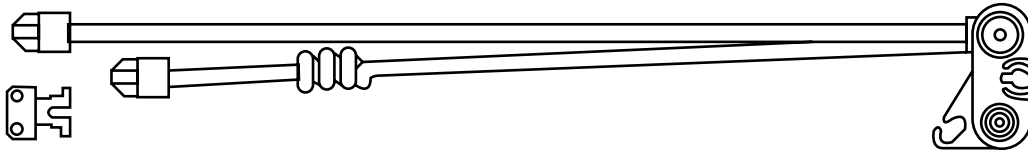

**WL009**

AUWARTER, DAF, KAROSA, KASSBOHRER, KNORR - BREMSEN, LIAZ, MERCEDES, SCANIA, TRAILERS

2 × 270mm

Fits Parts Nos: ACV041, ACV042

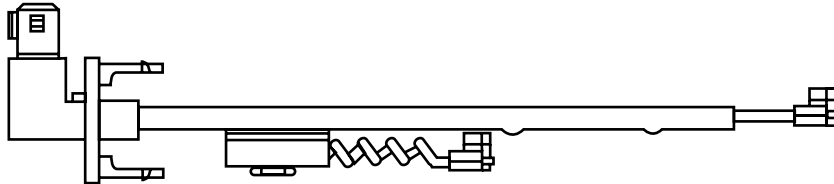

**WL010**

NISSAN, RENAULT, VAN HOOL

2 × 265mm

Fits Parts Nos: ACV033

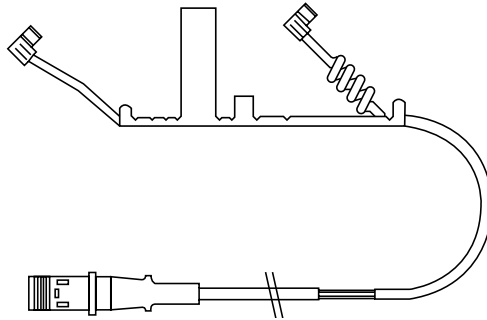

**WL011**

MAN

2 × 290mm

Fits Parts Nos: ACV058

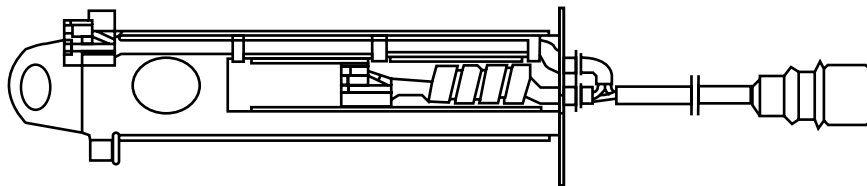

**WL012**

RENAULT

2 × 250mm

Fits Parts Nos: ACV039, ACV040



# Wear Indicator Illustrations

**ANL  
Braking**

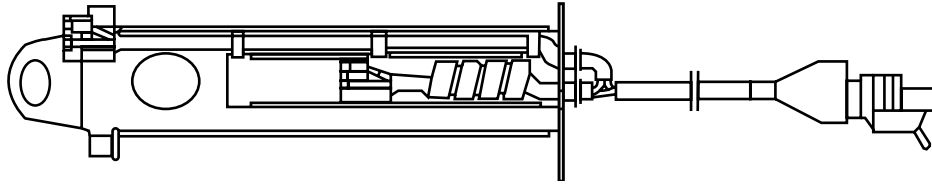

**WL013**

DAF, OPTARE

2 × 275mm

Fits Parts Nos: ACV039, ACV040

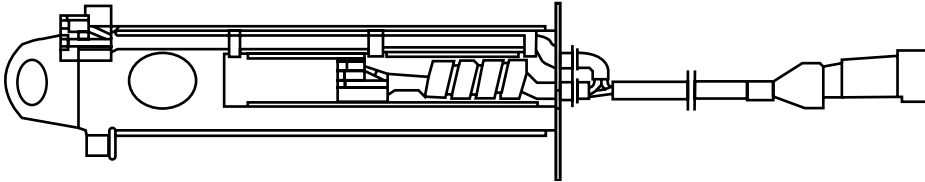

**WL014**

IVECO

2 × 300mm

Fits Parts Nos: ACV039, ACV040

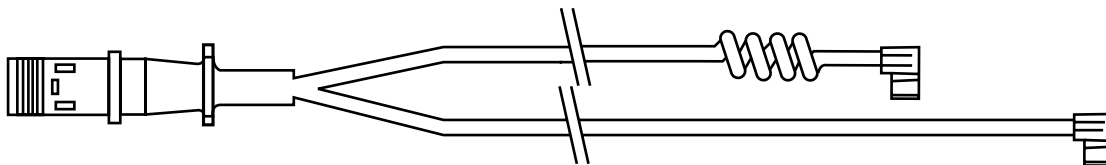

**WL015**

AUWARTER, BPW AXLES, DAF, DISCOS, GRANNING LYNX, KNORR - BREMSEN, MAN, SAE  
DUPILLIER, SAF / SAUER, TRAILERS, ZF AXLES

2 × 350mm

Fits Parts Nos: ACV025, ACV032, ACV036, ACV037, ACV043, ACV044

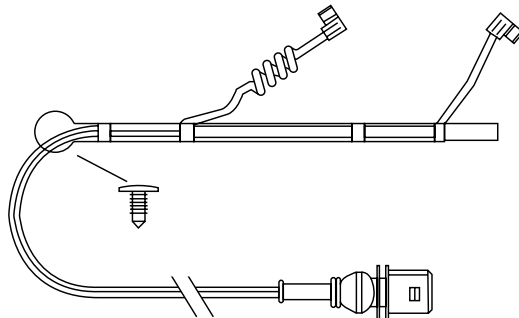

**WL016**

RENAULT

2 × 350mm

Fits Parts Nos: ACV058



# Wear Indicator Illustrations

**ANL  
Braking**

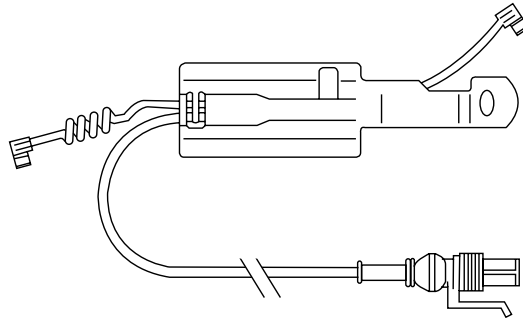

**WL017** | **DAF**

2 × 360 × mm

**Fits Parts Nos: ACV059**

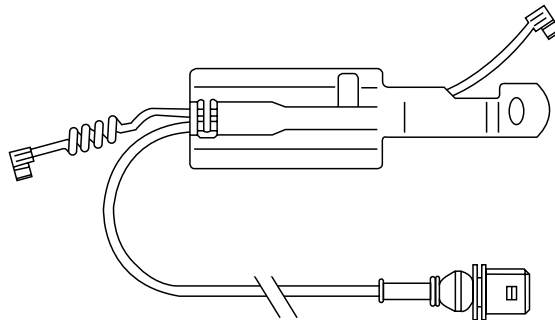

**WL018** | **RENAULT**

2 × 360 × mm

**Fits Parts Nos: ACV060**

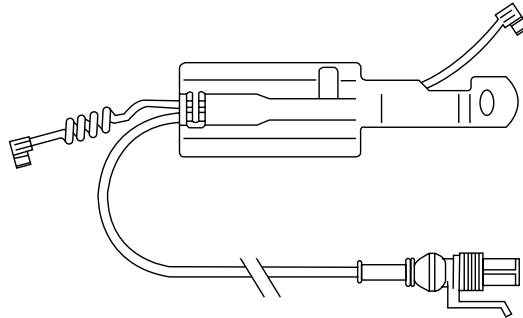

**WL019** | **DENNIS**

2 × 320mm

**Fits Parts Nos: ACV059**

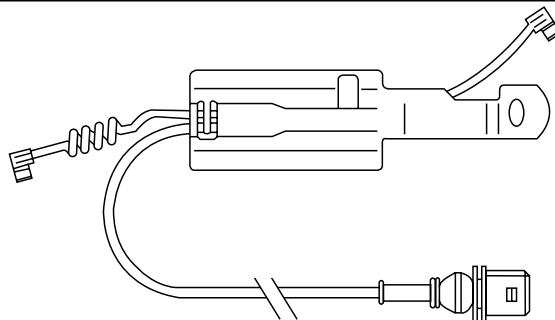

**WL020** | **RENAULT**

2 × 400mm

**Fits Parts Nos: ACV060**



# Wear Indicator Illustrations

## ANL Braking



**WL021**

VOLVO

2 × 230mm

Fits Parts Nos: ACV010, ACV032

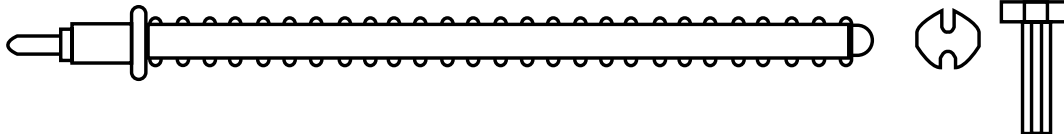

**WL022**

DENNIS, RENAULT

2 × 400mm

Fits Parts Nos: ACV015

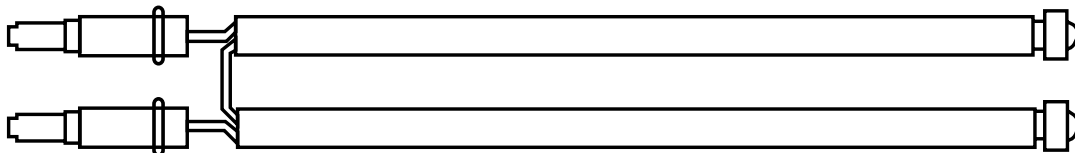

**WL023**

DENNIS, RENAULT

2 × 415mm

Fits Parts Nos: ACV015

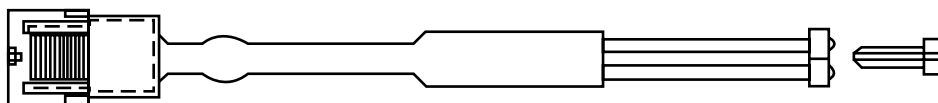

**WL024**

DENNIS, RENAULT

2 × 580mm

Fits Parts Nos: ACV015





# Wear Indicator Illustrations

ANL  
Braking

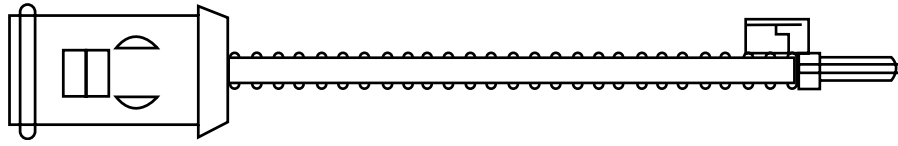

**WL025**

IVECO, RENAULT

2 × 495mm

Fits Parts Nos: ACV007, ACV011, ACV021, ACV032

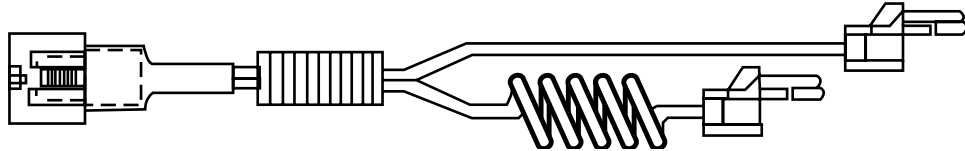

**WL026**

RENAULT

2 × 885mm

Fits Parts Nos: ACV011, ACV014, ACV021, ACV030, ACV032

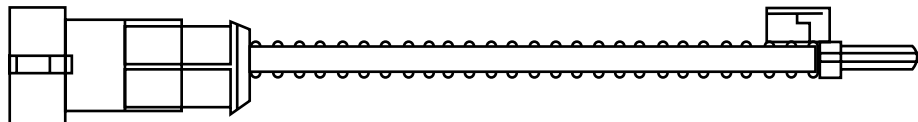

**WL027**

IVECO

2 × 495mm

Fits Parts Nos: ACV011, ACV021, ACV032

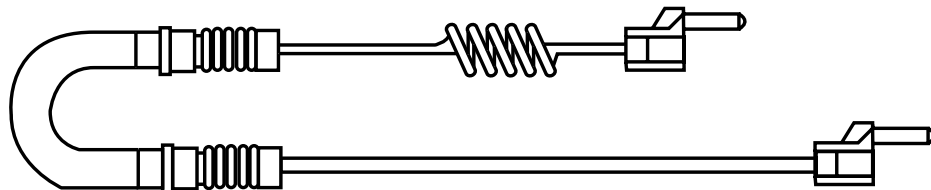

**WL028**

AUWARTER, MERCEDES, OPTARE

2 × 500mm

Fits Parts Nos: ACV002, ACV014, ACV030, ACV032



# Wear Indicator Illustrations

## ANL Braking



**WL029**

MERCEDES

2 × 94mm

Fits Parts Nos: ADB0238,



**WL030**

MERCEDES

2 × 212mm

Fits Parts Nos: ADB0212, ADB0271, ADB0453, ADB0478, ADB0480, ADB0914

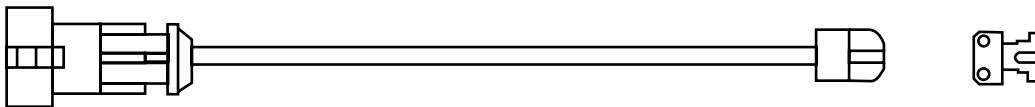

**WL031**

IVECO

2 × 265mm

Fits Parts Nos: ADB0909, ADB0931, ADB01034, ADB01173, ADB11030

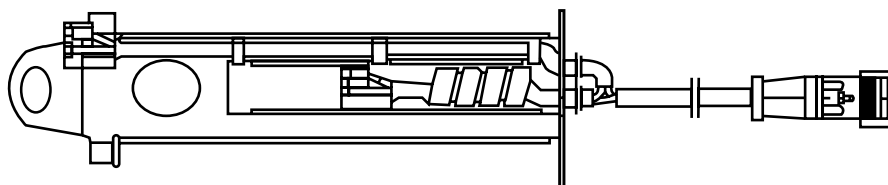

**WL032**

MAN

2 × 290mm

Fits Parts Nos: ACV039, ACV040,



## Fitting Kit Illustrations

SECTION

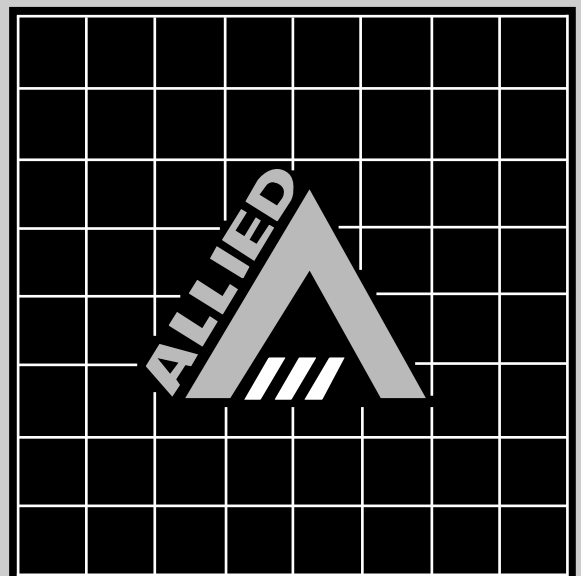



# Fitting Kit Illustrations

## ANL Braking



**K001**

AUWARTER, DAF, KASSBOHRER, KNORR - BREMSEN, MAN, MOSELEY / BOVA,  
VAN HOOL,

Fits Parts Nos: ACV006,

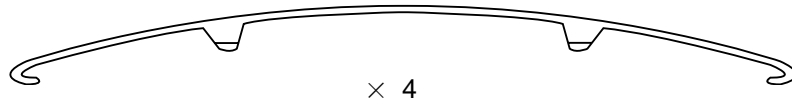

**K002**

AUWARTER, DENNIS, ERF, HEULIEZ, KAROSA, KASSBOHRER, MAN, MERCEDES,  
MERITOR, RENAULT, TRAILERS, VAN HOOL,

Fits Parts Nos: ACV014, ACV058,

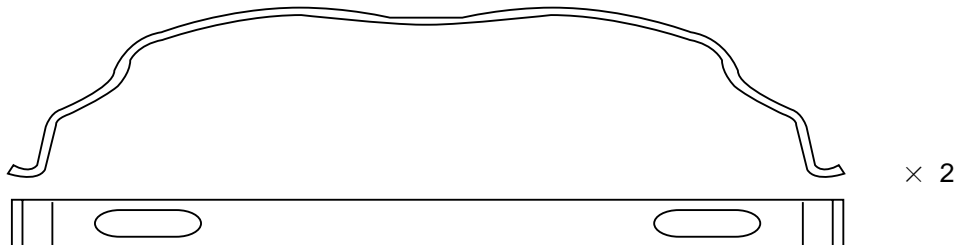

**K003**

DENNIS, HEULIEZ, MERITOR, RENAULT, TRAILERS, VOLVO,

Fits Parts Nos: ACV029,

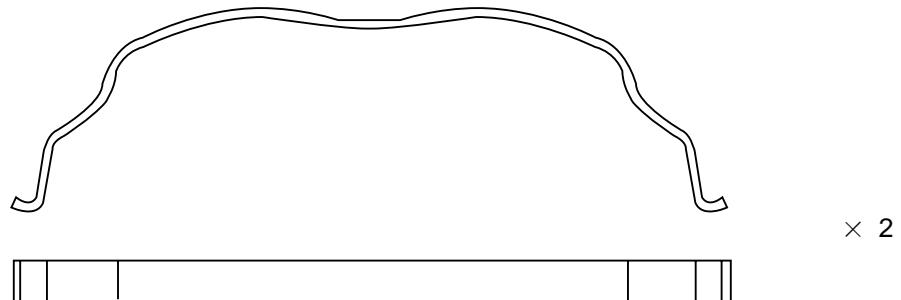

**K004**

MERITOR, NISSAN, RENAULT, TRAILERS, VAN HOOL,

Fits Parts Nos: ACV033,



# Fitting Kit Illustrations

## ANL Braking

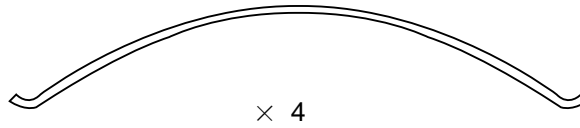

**K005**

AUWARTER, BPW AXLES, DAF, DENNIS, DISCOS, FRUEHAUF, GRANNING LYNX, HENDRICKSON, IVECO, KAROSA, KASSBOHRER, KNORR - BREMSSEN, LECINENA, LIAZ, MAN, MERCEDES, MERCEDES AXLES, SAE DUPILLIER, SAF / SAUER, SCANIA, TRAILERS, YORK, ZF AXLES,  
Fits Parts Nos: ACV036, ACV037, ACV038, ACV041, ACV042, ACV043, ACV044, ACV061, ACV062, ACV063,

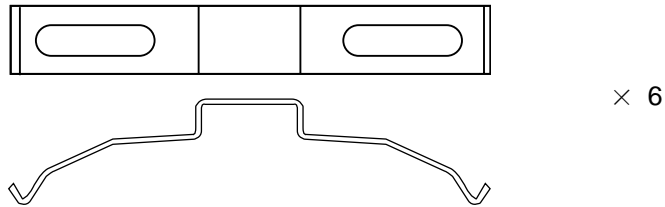

**K006**

DAF, IVECO, MAN, RENAULT,

Fits Parts Nos: ACV039, ACV040,

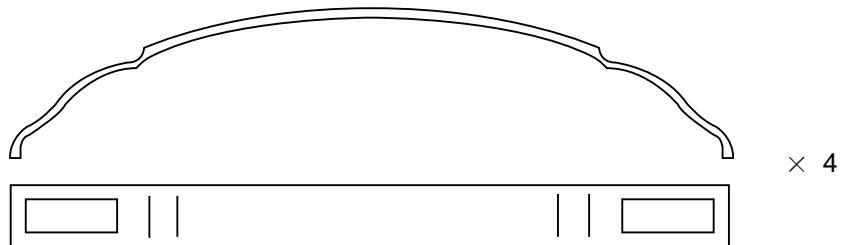

**K007**

DEN OUDSTEN, MERITOR, TRAILERS,

Fits Parts Nos: ACV047, ACV057,

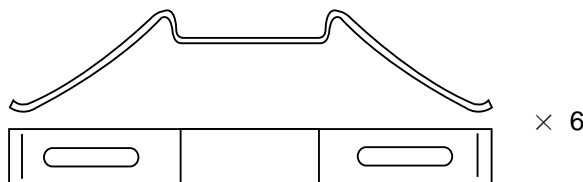

**K008**

DISCOS, FRUEHAUF, MERCEDES AXLES, SAF / SAUER,

Fits Parts Nos: ACV048,



# Fitting Kit Illustrations

## ANL Braking

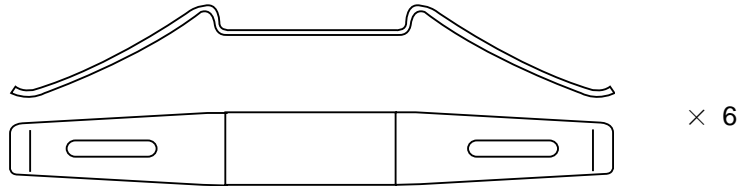

**K009**

DAF, DISCOS, FRUEHAUF, MERCEDES AXLES, SAF / SAUER,

Fits Parts Nos: ACV049,

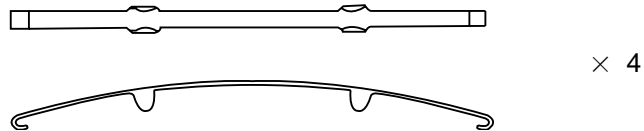

**K010**

MERITOR, TRAILERS, VOLVO,

Fits Parts Nos: ACV050,



**K011**

MERITOR, TRAILERS, VOLVO,

Fits Parts Nos: ACV051,

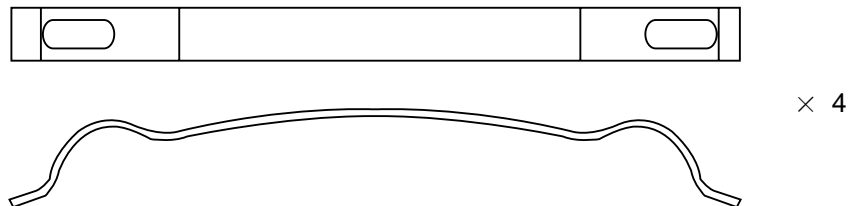

**K012**

DISCOS, FRUEHAUF, HALDEX BRAKES, MERCEDES AXLES, SAF / SAUER, TRAILERS,

Fits Parts Nos: ACV053, ACV054,



# Fitting Kit Illustrations

## ANL Braking

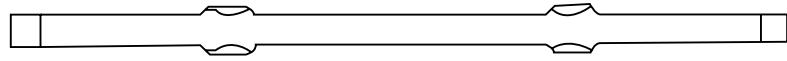

× 4



**K013**

AUWARTER, DENNIS, ERF, HEULIEZ, KAROSA, KASSBOHRER, MAN, MERCEDES,  
MERITOR, RENAULT, TRAILERS, VAN HOOL, VOLVO,

Fits Parts Nos: ACV030, ACV055,

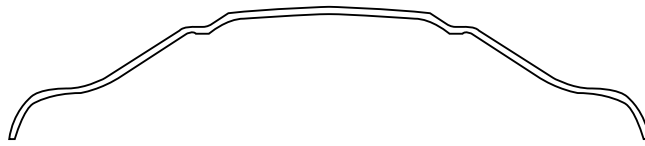

× 4



**K014**

AUTODROMO, MERITOR, TRAILERS,

Fits Parts Nos: ACV056,



× 4



**K015**

DAF, DENNIS, RENAULT,

Fits Parts Nos: ACV059, ACV060,

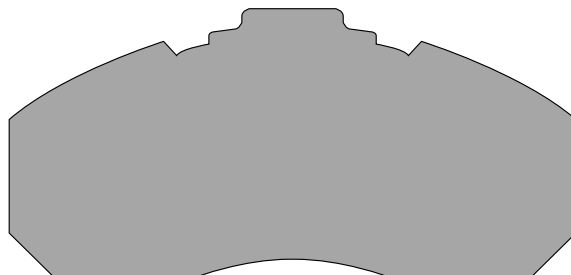

× 2

**K016**

AUWARTER, DENNIS, ERF, HEULIEZ, KAROSA, KASSBOHRER, MAN, MERCEDES,  
MERITOR, RENAULT, TRAILERS, VAN HOOL,

Fits Parts Nos: ACV014, ACV030,



# Fitting Kit Illustrations

## ANL Braking

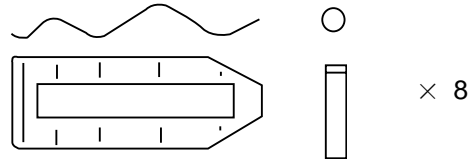

**K017**

DENNIS, HEULIEZ, MERITOR, RENAULT, TRAILERS, VOLVO,

Fits Parts Nos: ACV029,

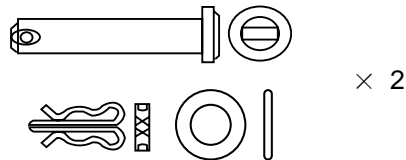

**K018**

AUWARTER, BPW AXLES, DAF, DENNIS, DISCOS, FRUEHAUF, GRANNING LYNX,  
HENDRICKSON, IVECO, KAROSA, KASSBOHRER, KNORR - BREMSEN, LECINENA, LIAZ,  
MAN, MERCEDES, MERCEDES AXLES, SAE DUPILLIER, SAF / SAUER, SCANIA, TRAILERS, YORK, ZF AXLES,

Fits Parts Nos: ACV036, ACV037, ACV038, ACV041, ACV042, ACV043, ACV044, ACV061, ACV062, ACV063,

Fits Parts Nos:

Fits Parts Nos:





## Interchange References

SECTION

F

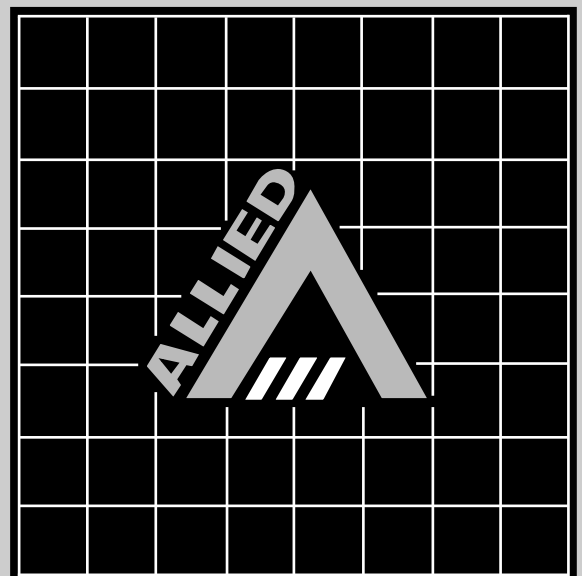



# Interchange Reference Summary

**ANL  
Braking**

ALLIED NIPPON	WVA	BENDIX/ JURID	DELPHI LOCKHEED	DON/ MINTEX	FERODO	LUCAS	PAGID
ACV001	29017 23.00	29017	LP0660	CVP003	FCV376	GDB356	T9006
ACV002	29835 21.50 / 20835 22.00	29835	LP0662	CVP002	FCV501	GDB481	T0354
ACV003	29024 23.00 / 29017 23.00	29024	LP0857	CVP027	FCV503		
ACV004	29302 22.00	29302	LP0661	CVP001	FCV523	GDB429	T0347
ACV005	29036 24.00	29036	LP0656		FCV575	GDB1150	T0087
ACV006	29747 32.00	29747	LP1028	CVP338	FCV594		T0376
ACV007	29033 22.00 / 29302 22.00	29033	LP1048	CVP007			
ACV008	29072 19.00	29072	LP1029	CVP011	FCV624		T9077
ACV009	29013 21.50	29013	LP0861	CVP006	FCV668		T0026
ACV010	29039 22.00	29039	LP8053	CVP008	FCV702	GDB761G	
ACV011	21302 22.00 / 29067 22.00	21302	LP0859	CVP019	FCV733	GDB453G / GDB5005G / GDB761G / GDB5020G	T9064
ACV012	29498 20.00 / 20498 20.00	29498					
ACV013	29044 20.00	29044	LP1032	CVP012	FCV753		T0093
ACV014	29030 28.00 / 29083 28.00 / 29113 28.00	29030	LP1047	CVP013	FCV760	GDB5001G / GDB5000G / GDB5010G / GDB5017G / GDB5014G / GDB5007G / GDB5009G	T9044
ACV015	29043 24.00	29043	LP1050	CVP009	FCV769 / FCV711		T0092
ACV016	29032 25.00	29032	LP0998	CVP014	FCV770		T9035
ACV017	29011 25.00	29011	LP0999	CVP015	FCV773		T9034
ACV018	29075 20.00	29075	LP1034	CVP010	FCV801		T9091
ACV020	29001 20.00	29001	LP8040	CVP017	FCV852		T9048
ACV021	29065 22.00	29065	LP0858	CVP016	FCV879	GDB5021G / GDB5004G / GDB842G	T9040 / T9036
ACV022	29017 23.00 / 29029 23.00	29017	LP1036	CVP005	FCV952		
ACV023	29074 20.00	29074	LP1033		FCV960		T9090
ACV025	29055 22.00	29055		CVP021	FCV987		T9072
ACV041	29059 30.00 / 29042 30.00 / 29060 30.00	29059	LP1039	CVP020 / CVP083	FCV988		T9063 / T9041
ACV027	29077 27.00	29077	LP1040	CVP022	FCV1042		T9076
ACV028	29097 20.50 / 29013 20.50	29097	LP1041	CVP031	FCV1046		T9071
ACV029	29090 28.00	29090	LP1042	CVP023	FCV1047	GDB5019G	T9059
ACV030	29053 30.00 / 29084 30.00 / 29113 30.00 / 29114 30.00	29053		CVP018	FCV760	GDB5001G / GDB5000G / GDB5010G / GDB5017G / GDB5014G / GDB5007G /  GDB5009G	T9044
ACV032	29122 22.00 / 29374 22.00	29122	GDB5007G /  GDB5009G	CVP025	FCV1126		T9055
ACV033	29100 25.00	29100			FCV1136		T9085
ACV034	29099 25.00	29099			FCV1159		T9092



# Interchange Reference Summary

## ANL Braking

ALLIED NIPPON	WVA	BENDIX/ JURID	DELPHI LOCKHEED	DON/ MINTEX	FERODO	LUCAS	PAGID
ACV036	29093 30.00 / 29094 30.00 / 29145 30.00	29093		CVP082 / CVP036	FCV1275		T9083
ACV037	29095 30.00	29095		CVP036 / CVP082	FCV1275		T9084
ACV038	29115 34.00 / 29115 27.00	29115		CVP035	FCV1277		T9087
ACV039	29088 26.00	29088		CVP032	FCV1279		T9060
ACV040	29091 27.00	29091		CVP033	POSS FDB1354		T9061
ACV041	29106 30.00 / 29105 30.00	29106	LP1039	CVP083 / CVP020	FCV1313		T9063
ACV042	29108 30.00 / 29087 30.00	29108	LP1039		FCV1328		T9063
ACV043	29095 30.00	29095		CVP036 / CVP082	FCV1275		T9084
ACV044	29095 30.00	29095		CVP036 / CVP082	FCV1275		T9084
ACV045	29107 20.00	29107					
ACV047	29124 27.00	29124		CVP024	FCV1314		T9086
ACV048	29126 30.00	29126		CVP090	FCV1389 / FCV1406 FCV1366		
ACV049	29146 30.00 / 29154 30.00	29146					
ACV050	29136 30.00	29136		CVP038	FCV1386		
ACV051	29137 30.00	29137		CVP039	FCV1387		
ACV053	29147 30.00	29147					
ACV054	29143 30.00 / 29120 30.00	29143			FCV1367		
ACV055	29125 30.00	29125		CVP037	FCV1388		
ACV056	29149 28.00	29149		CVP080			
ACV057	29150 30.00	29150		CVP081			
ACV058	29131 30.00	29131		CVP088	FCV1404		
ACV059	29141 30.00 / 29119 30.00	29141		CVP086			
ACV060	29142 30.00	29142		CVP087			
ACV061	29165 29.00	29165					
ACV062	29171 29.00	29171					
ACV063	29167 29.00	29167					
ADB0101	20228 15.00	571221	LP0076	MDB1081	FDB105	GDB152	T0449
ADB0111	20703 14.50	572120 / 572121	LP0074	MDB1069	FDB85	GDB295	T0809 / T0843
ADB0112	20073 17.50	571463	LP0030	MDB1013	FDB29	GDB106	T0616
ADB0118	20753 18.00 / 20783 18.00 / 20640 18.00	571536	LP0204	MDB1175	FDB206	GDB255	T4017
ADB0122	20128 14.50 /  20529 14.50	572101	LP0065	MDB1107	FDB39	GDB126	T0800 (T0861)
ADB0124	20979 19.50	571380	LP0548	MDB1362	FDB517	GDB399	T5012
ADB0125	20392 15.00 / 29581 15.00	571372 / 571553	LP0427	CVP069 / MDB1114	FDB143	GDB242	T4135
ADB0128	20011 15.00 / 20468 15.00	571215	LP0020	MDB1003 / MDB1235	FDB11	GDB100	T0475 / T0303
ADB0129	20950 18.00 / 20775 18.00 / 20776 18.00	571464	LP0509		FDB351		T9003
ADB0130	20731 15.50	572250	LP0208	MDB1184	FDB208	GDB254	T0854
ADB0132	21470 18.00	571745	LP0766	CVP062 / MDB1558	FDB700	GDB1084	T0389



# Interchange Reference Summary

**ANL  
Braking**

ALLIED NIPPON	WVA	BENDIX/ JURID	DELPHI LOCKHEED	DON/ MINTEX	FERODO	LUCAS	PAGID
ADB0134	20547 16.50 / 21353 16.50 /  21311 16.50	571924 / (571492 Has 2 W/I 695mm)	LP0702	MDB1556	FDB732	GDB1040	T1045
ADB0135	20939 15.40	571276 / 571539 / 571833	LP0415 / LP0581	MDB1141	FDB173 / FDB1036	GDB199	T0375 / T0841
ADB0142	21100 17.00		LP1444	MDB1606			
ADB0147	20341 17.50	571278 / 571552	LP0221	MDB1180	FDB243	GDB264	T4113
ADB0149	20887 19.50 / 20888 19.50	571317	LP0421	MDB1267	FDB419	GDB454	T0351
ADB0149	20887 19.50 / 20888 19.50	571317	LP0756	MDB1267	FDB419	GDB454	T4154
ADB0152	20168 16.00	571376	LP0770	MDB1570	FDB774	GDB1048	T5050
ADB0156	20491 15.00	571247	LP0154	MGB633	FDB167	GDB660	T4023
ADB0162	23452 18.00	571937	LP0913	MDB1701	FDB980	GDB1156	
ADB0168	20002 14.50	572331		MDB1346	FDB547		T0358
ADB0171	20289 15.30	572113	LP0078	MDB1054	FDB169	GDB232	T0805
ADB0177	21099 17.00 / 21229 17.00	572312	LP0358	MDB1279	FDB340	GDB318	
ADB0183	29071 17.00 / 29707 17.00 / 29947 17.00 / 20706 17.00	571368	LP1098	CVP075 / MDB1721	FCV627		T9014
ADB0186	21883 20.00 / 21884 20.00 / 21885 20.00	571934	LP1092	MDB1814	FDB1163	GDB1282	T1107
ADB0195	21142 15.00	572226	LP0527	MDB1318	FDB396	GDB383 / GDB3210	T0350
ADB0201	23552 18.00	571974	LP1549 / LP1796	MDB2076	FDB1376		
ADB0207	20958 16.00	572206 / 572208	LP0261	MDB1207	FDB293	GDB288 / GDB988	T0317
ADB0212	21576 19.30	571844	LP0980	CVP070 / MDB1739	FDB1038		T1111
ADB0224	20344 15.00	571803	LP0211	MLB43	FDB844 / FDB830	GDB974	
ADB0225	23083 19.00 / 23081 19.00						
ADB0228	21193 18.00	571448 / 571916	LP0677	MDB1513	FDB519	GDB958	T1030
ADB0232	21515 17.50 / 21516 17.50		LP1450	MDB1972	FDB1291		
ADB0238	20784 18.00 / 29784 18.00	571272	LP0468	CVP049 / MDB1585	FCV239	GDB317	T0311
ADB0239	20364 15.00	571233	LP0045	CVP041 / MLB40	FDB833	GDB340	T0571
ADB0243	20074 10.00	571226	LP0029	MDB1008	FDB22	GDB107	T0609
ADB0247	20011 18.50	571236	LP0061	MDB1005	FDB84	GDB407	T4116
ADB0256	21245 17.50		LP1210	MDB1927	FDB991		
ADB0258	20905 18.00	571911	LP1053	MDB1807		GDB1277	
ADB0264	20729 15.00	572326	LP0199	MDB1144	FDB186	GDB233	T0329
ADB0265	20852 15.00	572178	LP0448	MDB1139	FDB288	GDB352	T0882
ADB0271	29076 19.50		LP1046	CVP073 / MDB1802	FCV1043		T9057
ADB0272	21882 17.00 / 21748 17.00	571875	LP1019	MDB1744	FDB1132		T5089
ADB0276	20863 16.50	572361	LP0373	MDB1204	FDB643 / FDB808	GDB251	T0859
ADB0297	21158 15.00	572363	LP0538	MDB1334	FDB318	GDB351	T0331



# Interchange Reference Summary

**ANL  
Braking**

ALLIED NIPPON	WVA	BENDIX/ JURID	DELPHI LOCKHEED	DON/ MINTEX	FERODO	LUCAS	PAGID
ADB0306	21115 16.00	572335	LP0476	MDB1310	FDB418	GDB345	T0337
ADB0312	20323 16.50	571543	LP0087	MDB1099	FDB116	GDB611 / GDB684	T0465
ADB0313	20313 14.30 / 20736 14.30	571809	LP0071		FDB40	GDB139	T0807
ADB0316	21109 15.50 / 20476 15.50	572302	LP0529	MDB1138 / MDB1329	FDB170	GDB828 / GDB180	T0343 / T0835
ADB0319	20359 18.00	571250	LP0041	CVP040 / MLB41	FDB829 / FDB886	GDB341	T0559
ADB0323	21243 14.00	572293	LP0400	MDB1328	FDB532	GDB980	T0335
ADB0368	20718 14.50	572230	LP0219	MDB1183	FDB225	GDB197	T0838
ADB0389	20088 14.00	571204	LP0015	MDB1723 / MGB533	FDB809 / FDB811	GDB1066 / GDB533	T0230
ADB0390	21141 18.00	571336	LP0488	CVP052 / MDB1341	FDB450	GDB349	T0348
ADB0391	20628 15.00	572316	LP0230	MDB1162	FDB215	GDB190	T0865
ADB0393	21171 17.80	571726	LP0673	MDB1493	FDB617 / FDB703	GDB897	T9012
ADB0397	20857 17.25	571312	LP0351	MDB1225	FDB365	GDB311	T1003
ADB0401	21459 18.00		LP0481	MLB115	FDB747	GDB394	
ADB0404	21947 15.00	572245	LP0963	MDB1696	FDB1021	GDB3110 / GDB1182	T3064
ADB0419	21479 18.30	571847	LP0918	MDB1682	FDB970	GDB1092	T5072
ADB0423	21347 17.00		LP0726	MDB1372	FDB641	GDB1017	
ADB0431	21463 18.00		LP0838	MDB2192			
ADB0440	21689 15.50	572378	LP0950	MDB1535	FDB949	GDB3109	T3012
ADB0444	23104 18.00 / 23103 18.00 / 20753 18.00	571914	LP1604	MDB1883	FDB1081	GDB1222	T1141
ADB0447	21481 15.50	572382	LP0847	MDB1657	FDB909	GDB1113	T3037
ADB0453	21621 16.60	571846	LP1595	CVP071 / MDB1737	FDB1039		T1142
ADB0459	21468 15.50	572367	LP0989	MDB1398		GDB770	T3083
ADB0467	21518 17.00	571436	LP0653	MDB1419	FDB603	GDB859	T5073
ADB0478	21592 18.00	571910	LP1596	MDB1738	FDB1045		T1124
ADB0479	21930 17.40 / 21931 17.40 / 21932 17.40	571972 / 571949	LP1385	MDB1956			
ADB0480	23022 20.50	571946	LP1425	MDB1967	FDB1304		T1168
ADB0485	21978 18.00 / 21980 18.00 / 23205 18.00	571930 / 571931	LP1610	MDB1837	FDB1135		
ADB0502	21202 17.20	571412	LP0591	MDB1404	FDB589	GDB953	T1022
ADB0511	20168 19.30	571357	LP0778	MDB1571	FDB775	GDB1044	T5051
ADB0515	20988 17.50 / 20989 17.50 / 21080 17.50	571320			FDB455	GDB808	T2017 / T2018
ADB0552	21542 14.00	572165	LP0811	MDB1486	FDB935		
ADB0567	20422 17.50	571244	LP0110	MDB1110	FDB149	GDB624	T0672
ADB0570	21827 17.00 / 21430 17.00	571902	LP1597	MDB1808	FDB1168		T1137
ADB0589	21249 15.50 / 21369 15.50		LP0739	MDB1465	FDB518	GDB3130	
ADB0706	21866 19.00	571915	LP1591	MDB1804	FDB1054	GDB1218	T1097
ADB0707	21866 17.00	571923	LP1601	MDB1805	FDB1101	GDB1274	T1094
ADB0731	20034 14.50 / 20107 14.50 / 20755 14.50 / 20630 14.50 / 20397 14.50	571213 / 571279 / 571417 / 571554	LP0018	MDB1002 / MDB1068 / MDB2129	FDB2 / FDB704	GDB101 / GDB391 / GDB910 / GDB1160	T0479 / T0481 / T4114
ADB0733				MDB1931			



# Interchange Reference Summary

**ANL  
Braking**

ALLIED NIPPON	WVA	BENDIX/JURID	DELPHI LOCKHEED	DON/MINTEX	FERODO	LUCAS	PAGID
ADB0734			LP1430	MDB1761		GDB3234	
ADB0758			LP1146	MDB2025		GDB3117	
ADB0770	20780 13.50	572118	LP0578	MDB1429	FDB549	GDB736	T0013
ADB0832	23539 17.50	572452	LP1438	MDB1905		GDB3198	
ADB0873	23615 17.50		LP1652	MDB2152			
ADB0874	23224 17.00		LP1745 / LP1455	MDB1952			
ADB0876	23102 17.20 / 23101 17.20 / 21202 17.20	571913	LP1603	MDB1884	FDB1082	GDB1221	T1113
ADB0888	23020 18.00	571947	LP1471	MDB2002	FDB1305		T1169
ADB0891	23202 18.00		LP1469	MDB2060	FDB1394		
ADB0892	23346 17.50 / 23124 17.5	571966	LP1624	MDB2067	FDB1477		
ADB0899	23200 18.00		LP1470	MDB2059	FDB1393		
ADB0909	29121 17.00						
ADB0914	23021 18.50	571950	LP1437	MDB1997	FDB1306		
ADB0924	21469 18.00	571746	LP0767	CVP063 / MDB1559	FDB701	GDB1080	T0390
ADB0925	20652 18.00	571458	LP0785	MDB1563	FDB722	GDB791	T5066
ADB0928	20861 17.50 / 21662 17.50	571540	LP1429	MDB1913	FDB610	GDB687 / GDB473	T5054
ADB0931	29121 19.50 / 29357 19.50		LP1616	CVP026 / MDB2026	FCV1102		T9058
ADB0952			LP1431	MDB2021		GDB3136	
ADB0953	21634 18.00 / 21635 18.00	571948	LP1206	MDB1822	FDB1131		
ADB0989	21945 16.00	571969	LP1409	MDB1868	FDB1312		T5095
ADB0991	29706 16.50 / 29984 16.50 / 29947 16.50	571885	LP0828	CVP064 / MDB1471	FCV791	GDB827	T9004
ADB01018	23181 17.50		LP1474	MDB2206	FDB1160		
ADB01021	23302 18.00	571932	LP1406	MDB1993	FDB1292		
ADB01034	29123 20.00						
ADB01035	23616 17.80		LP1746	MDB2268	FDB1452		
ADB01036	23669 16.80		LP1747	MDB2269	FDB1453		
ADB01042			LP1790		FDB1480		
ADB01052	21519 18.00	571827	LP0506	MLB114	FDB871	GDB395	
ADB01066	20904 18.00	571822	LP0413	CVP048 / MLB69	FDB690 / FDB836	GDB760	T0082
ADB01073	20124 18.00	571460	LP0668	MDB1537	FDB785	GDB862	T5048
ADB01078	23471 14.50		LP0777	MDB1645	FDB872		T9051
ADB01086		572334	LP0981	MDB1449	FDB933	GDB1022	
ADB01087				MDB2028			
ADB01088							
ADB01089	21573 14.00 / 20932 14.00	571521	LP0735	CVP061 / MDB1649	FDB941	GDB1114	T9025
ADB01093	23458 15.50		LP0914	MDB1755	FDB981	GDB1155	
ADB01127	23099 18.00		LP1695	MDB2159	FDB1515	GDB1478	
ADB01150	23440 17.50		LP1724	MDB2272			
ADB01153	23482 16.80						
ADB01157							
ADB1133	20937 18.00 / 20772 18.00 / 20478 18.00	571327	LP0248	MDB1214	FDB270	GDB807	T2009 / T5077
ADB1142	21100 17.00 / 21105 17.00	571330	LP0566	MDB1384	FDB524	GDB833	T0353
ADB1142	23068 17.00 / 21100 17.00		LP1027	MDB1961		GDB852	
ADB1174	23124 17.5	571919	LP1607	MDB1812	FDB1112	GDB1260	T5099



# Interchange Reference Summary

**ANL  
Braking**

ALLIED NIPPON	WVA	BENDIX/ JURID	DELPHI LOCKHEED	DON/ MINTEX	FERODO	LUCAS	PAGID
ADB1183	29985 16.50	572374	LP1096	CVP074 / MDB1490		GDB1077	T9020
ADB1191	20989 17.50 / 21023 17.50 / 20923 17.50	571319	LP0493	MDB1327	FDB434	GDB788 / GDB446	T2006
ADB1204	20708 16.50 / 20946 16.50	571454	LP0436		FDB364	GDB422	T5016
ADB1204	20708 16.50	571318	LP0732	MDB1528			
ADB1205	20145 17.50	571206	LP0106	MDB1192	FDB42	GDB151	T0264
ADB1224	20344 16.00 / 21237 16.00	571440	LP0475	MLB105	FDB471	GDB976	T9052
ADB1228	21195 18.00	571449	LP0604	MDB1430	FDB509	GDB960	T1029
ADB1235	29040 18.00 / 20465 18.00	571419	LP0584	MDB1367	FCV516	GDB390	T0045
ADB1254	20741 19.00	571304	LP0378	CVP047 / MDB1205	FDB287	GDB695	T0290
ADB1275	21629 19.00 / 21799 19.00	571840	LP0878	CVP068 / MDB1704	FDB968	GDB1106	T5079
ADB1308	20455 19.00 / 20454 19.00 / 20452 19.00	571228	LP0108	MDB1108	FDB142	GDB173	T4099
ADB1319	21160 18.00 / 20359 18.00	571442	LP0472	MLB79	FDB656	GDB759	T0062
ADB1392	20754 14.50	571549 / 571294	LP0435	MLB65 / MLB81	FDB842 / FDB840	GDB336 / GDB387	T0510
ADB1396	21084 17.50 / 21085 17.50	571401	LP0254	MDB1224	FDB274	GDB428	T5019
ADB1401	21459 18.00	571439	LP0730	MLB116 / MDB2151	FDB520	GDB1093	
ADB1412	20359 18.00	571379	LP0213	CVP051 / MLB76	FDB839	GDB342	T0559
ADB1413	20359 18.00 / 21160 18.00		LP0651	MLB85	FDB841	GDB789	
ADB1419	21479 18.30		LP1542	MDB2177			
ADB1431	21463 18.00	571526	LP0885	MDB1628	FDB845	GDB400	T5077
ADB1437	29041 18.30 / 21048 18.30	571422	LP0863	CVP066 / MDB1644 / MDB1759	FDB655	GDB478	T0091
ADB1455	21904 17.00 / 21572 17.00	571845	LP1043 / LP0667	MDB1855	FVR1044		T1125
ADB1479	21930 17.40 / 21931 17.40 / 21932 17.40	571882	LP1585	MDB1733	FDB1040		
ADB1515	20988 17.50 / 20989 17.50 / 21080 17.50	571320	LP0536	MDB1300	FDB455	GDB808	T2017 / T2018
ADB1570	21430 17.00 / 21432 17.00	571509	LP0793	MDB1662	FDB876	GDB1104	T1075
ADB1852	21885 20.00		LP1707	MDB2104			
ADB1874	23224 17.00			MDB1953			
ADB1907							
ADB1926	21614 17.50	571406	LP0823	MDB1611	FDB687	GDB790	T5074
ADB1953	23176 18.00 / 21634 18.00 / 21635 18.00		LP1535	MDB2095			
ADB1991	29984 16.50 / 29706 16.60		LP1105	MDB1729	FCV792	GDB1069	T9013
ADB11001	21801 18.00	571838	LP0909	MDB1702	FDB1000	GDB1148	T5084
ADB11028	29138 18.00						
ADB11029	29139 18.00		LP1776	MDB2049			
ADB11030	29140 18.00		LP1775	MDB2156			



# Interchange Reference Summary

**ANL  
Braking**

ALLIED NIPPON	WVA	BENDIX/ JURID	DELPHI LOCKHEED	DON/ MINTEX	FERODO	LUCAS	PAGID
ADB11031	23602 19.00		LP1748	MDB2157	FDB1396		
ADB11032	23603 19.00		LP1749	MDB2158	FDB1397		
ADB11040	23602 19.00		LP1750	MDB2328	FDB1478		
ADB11041	23603 19.00		LP1751	MDB2329	FDB1479		
ADB11047	21049 18.30 / 21048 18.30	571325	LP0501	CVP053 / MDB1307	FDB377	GDB343	T5018
ADB11051	21006 18.00 / 20465 18.00	571446	LP0583	CVP057 / MDB1340	FCV492	GDB389	T0383
ADB11054	21188 18.30 / 21048 18.30	571447	LP0580	CVP065 / MDB1524	FDB511	GDB1152	T0040
ADB11055	21459 18.00 / 21897 18.00	571439	LP0599				T0063
ADB11059	20359 18.00 / 20653 18.00	571444	LP0480	CVP050 / MDB1699	FDB543		T0048
ADB11068	29012 18.00		LP0833	MDB1730	FCV709		T0382
ADB11069	29037 18.50 / 22038 18.50	571416	LP0970	MDB1561	FDB713	GDB1111	
ADB11151	23446 16.50		LP1733 / LP1541	MDB2096			
ADB11168	23034 18.50		LP1529	MDB1954			
ADB2219	21627 19.00 / 21797 19.00	571839	LP0877	CVP067 / MDB1703	FDB967	GDB1105	T5078
ADB2258	20905 18.00 / 20986 18.00 / 21061 18.00	571332 / 571333	LP0490	MDB1291	FDB393	GDB327	
ADB2310	20635 18.00	571302 / 571734	LP0350	MDB1209	FDB428 / FDB254	GDB313	T6028
ADB2416	21061 18.00 / 20906 18.00 / 21609 18.00	571525 / 571743	LP0696	MDB1519	FDB719	GDB1033	T9028 / T9029
ADB2485	21978 18.00 / 21980 18.00 / 23205 18.00		LP1519	MDB2055			
ADB2533	21096 15.00 / 20634 15.00	571331	LP0491	MDB1331	FDB440	GDB328	T6064
ADB2714	23003 18.30 / 23042 18.00	571843	LP1592	MDB1815	FDB1002		T9054
ADB21048	20926 18.50 / 20928 18.50	571306	LP0504	CVP054 / MDB1333	FDB414	GDB344	T9000
ADB3168	20002 14.50	572332	LP0530	MDB1439	FDB757	GDB737	
ADB3170	21775 15.00	572253	LP0962	MDB1695		GDB1154	T3076
ADB3207	21224 16.00 / 20958 16.00	572207	LP0744	MDB1381		GDB732	T0003
ADB3225	23083 19.00 / 23081 19.00		LP1599	MDB1762	FDB1014		T3036
ADB3232	21515 17.50 / 21516 17.50	571438 / 571976	LP0619 / LP0911	MDB1659	FDB613	GDB496	T5065
ADB3233	21842 15.50 / 21840 15.50	572200	LP0954	MDB1646	FDB804	GDB1127	T3019
ADB3234	21769 15.70 / 21363 15.70 / 21768 15.70	572370	LP0871	MDB1539	FDB765	GDB1126	T3025
ADB3269	23290 17.00	572282	LP1010	MDB1823	FDB1422	GDB1286	T0398
ADB3273	21502 15.00 / 21500 15.00	572166	LP0684	MDB1464	FDB712	GDB885	T3007
ADB3285	20892 15.00 / 21537 15.00 / 21318 15.00	572244	LP0630	MDB1577 / MDB1440	FDB902	GDB1026	T0023
ADB3295	21373 16.20	572281	LP0633	MDB1446	FDB556	GDB729	T0044
ADB3320		572279	LP0870	MDB1422	FDB633	GDB977	





# Interchange Reference Summary

**ANL  
Braking**

ALLIED NIPPON	WVA	BENDIX/ JURID	DELPHI LOCKHEED	DON/ MINTEX	FERODO	LUCAS	PAGID
ADB3322	21544 16.50 / 21467 16.50 / 21543 16.50	572271	LP0629	MDB1421	FDB678	GDB870	T3003
ADB3330	21718 16.00 / 21716 16.00	572397	LP0952	MDB1590	FDB940	GDB1013	T3027
ADB3333	21680 15.00 / 21679 15.00	572140	LP0854 / LP1405	MDB1647 / MDB2203	FDB797	GDB797 / GDB3213	T3011
ADB3368	20718 14.50	572233	LP0687	MDB1380	FDB717	GDB1020	
ADB3387	21119 17.00 / 21099 17.00	572313	LP0707	MDB1280		GDB367	T0004
ADB3393	23300 18.50	571964	LP1139	MDB1842	FDB1276	GDB1349	
ADB3399	20766 15.00 / 20854 15.00	572177	LP0220	MDB1166	FDB219	GDB210 / GDB211	T0363 / T0885
ADB3400	20767 15.00	572172	LP0634		FDB326		T0019
ADB3402	21549 14.80 / 21547 14.80	572211	LP0817	MDB1508	FDB918		T3001
ADB3422	20182 15.50	572304	LP0409	MDB1297	FDB306	GDB388	T0007
ADB3439	21967 14.00	572278	LP0944	MDB1592 / MDB2184 MDB1591	FDB938	GDB1135	T3069
ADB3451	21709 15.50 / 21711 15.50	572270	LP0819		FDB919		T3030
ADB3457	21952 15.50	572409	LP1064	MDB1862	FDB1009	GDB3071	
ADB3481	23536 15.50	572442	LP1434	MDB1903			
ADB3518	21333 15.00 / 21334 15.00	572179	LP0676	MDB1474	FDB588	GDB750 / GDB883	T0032
ADB3583	23116 19.60 / 23060 19.60 / 23056 19.60	571975	LP1309	MDB1907	FDB1295		T1145
ADB3584	23063 17.00	571968	LP1673	MDB1908	FDB1293		T1144
ADB3587	21907 15.00	572247	LP0967	MDB1690	FDB1020	GDB1174 / GDB3182	T3081
ADB3721	23484 17.00		LP1664	MDB1923			
ADB3746	21837 15.50 / 21835 15.50 / 21836 15.50	572342	LP0941	MDB1545	FDB930		T0395
ADB3750	23258 17.00 / 21991 17.00 / 23052 17.00		LP1307	MDB1904	FDB1294		
ADB3812							
ADB3813	21983 17.30		LP1398	MDB1995	FDB1384		
ADB3831	23524 17.70	572451	LP1308	MDB1906		GDB3197	
ADB3863	21348 17.00	572373	LP0543	MDB1482			T0009
ADB3887	21470 18.00		LP1417	MDB2000	FDB1338		
ADB3918							
ADB3919							
ADB3924	21469 18.00		LP1418	MDB2001	FDB1339		
ADB3945	21861 15.00	571941	LP1593	MDB1831	FDB1095		T5100
ADB31014	23472 17.50		LP1625	MDB1785	FDB1129		
ADB31090	21784 15.00	572254	LP0951	MDB1514	FDB942		
ADB31107	23434 18.00		LP1583	MDB2078	FDB1461		
ADB31108	23577 18.00 / 23430 18.00		LP1582	MDB2061	FDB1381		
ADB31112	23225 17.00 / 23226 17.00		LP1676	MDB2073			
ADB31113	23507 15.00		LP1442	MDB1987			
ADB31161							
ADB4129	20950 18.00 / 20951 18.00 / 20776 18.00	571297	LP0353	MDB1218	FDB346	GDB297	T0624
ADB4137	20833 17.00 / 20838 17.00	571309	LP0459	MDB1240	FDB370	GDB458	T0221



# Interchange Reference Summary

**ANL  
Braking**

<b>ALLIED NIPPON</b>	<b>WVA</b>	<b>BENDIX/ JURID</b>	<b>DELPHI LOCKHEED</b>	<b>DON/ MINTEX</b>	<b>FERODO</b>	<b>LUCAS</b>	<b>PAGID</b>
ADB4311	20347 14.00 / 20494 14.00 / 20710 14.00 / 20140 14.00	571224	LP0056 / LP0099	MDB1151 / MDB1027	FDB72 / FDB361	GDB148 / GDB908	T0697



# Interchange Reference

## ANL Braking

BENDIX/ JURID	ALLIED NIPPON	BENDIX/ JURID	ALLIED NIPPON	BENDIX/ JURID	ALLIED NIPPON	BENDIX/ JURID	ALLIED NIPPON
21302	ACV011	571224	ADB4311	571521	ADB01089	572113	ADB0171
29001	ACV020	571226	ADB0243	571525	ADB2416	572118	ADB0770
29011	ACV017	571228	ADB1308	571526	ADB1431	572120	ADB0111
29013	ACV009	571233	ADB0239	571536	ADB0118	572121	ADB0111
29017	ACV001	571236	ADB0247	571539	ADB0135	572140	ADB3333
29017	ACV022	571244	ADB0567	571540	ADB0928	572165	ADB0552
29024	ACV003	571247	ADB0156	571543	ADB0312	572166	ADB3273
29030	ACV014	571250	ADB0319	571549	ADB1392	572172	ADB3400
29032	ACV016	571272	ADB0238	571552	ADB0147	572177	ADB3399
29033	ACV007	571276	ADB0135	571553	ADB0125	572178	ADB0265
29036	ACV005	571278	ADB0147	571554	ADB0731	572179	ADB3518
29039	ACV010	571279	ADB0731	571726	ADB0393	572200	ADB3233
29043	ACV015	571294	ADB1392	571734	ADB2310	572206	ADB0207
29044	ACV013	571297	ADB4129	571743	ADB2416	572207	ADB3207
29053	ACV030	571302	ADB2310	571745	ADB0132	572208	ADB0207
29055	ACV025	571304	ADB1254	571746	ADB0924	572211	ADB3402
29059	ACV041	571306	ADB21048	571803	ADB0224	572226	ADB0195
29065	ACV021	571309	ADB4137	571809	ADB0313	572230	ADB0368
29072	ACV008	571312	ADB0397	571822	ADB01066	572233	ADB3368
29074	ACV023	571317	ADB0149	571827	ADB01052	572244	ADB3285
29075	ACV018	571317	ADB0149	571833	ADB0135	572245	ADB0404
29077	ACV027	571318	ADB1204	571838	ADB11001	572247	ADB3587
29088	ACV039	571319	ADB1191	571839	ADB2219	572250	ADB0130
29090	ACV029	571320	ADB0515	571840	ADB1275	572253	ADB3170
29091	ACV040	571320	ADB1515	571843	ADB2714	572254	ADB31090
29093	ACV036	571325	ADB11047	571844	ADB0212	572270	ADB3451
29095	ACV037	571327	ADB1133	571845	ADB1455	572271	ADB3322
29095	ACV043	571330	ADB1142	571846	ADB0453	572278	ADB3439
29095	ACV044	571331	ADB2533	571847	ADB0419	572279	ADB3320
29097	ACV028	571332	ADB2258	571875	ADB0272	572281	ADB3295
29099	ACV034	571333	ADB2258	571882	ADB1479	572282	ADB3269
29100	ACV033	571336	ADB0390	571885	ADB0991	572293	ADB0323
29106	ACV041	571357	ADB0511	571902	ADB0570	572302	ADB0316
29107	ACV045	571368	ADB0183	571910	ADB0478	572304	ADB3422
29108	ACV042	571372	ADB0125	571911	ADB0258	572312	ADB0177
29115	ACV038	571376	ADB0152	571913	ADB0876	572313	ADB3387
29122	ACV032	571379	ADB1412	571914	ADB0444	572316	ADB0391
29124	ACV047	571380	ADB0124	571915	ADB0706	572326	ADB0264
29125	ACV055	571401	ADB1396	571916	ADB0228	572331	ADB0168
29126	ACV048	571406	ADB1926	571919	ADB1174	572332	ADB3168
29131	ACV058	571412	ADB0502	571923	ADB0707	572334	ADB01086
29136	ACV050	571416	ADB11069	571924	ADB0134	572335	ADB0306
29137	ACV051	571417	ADB0731	571930	ADB0485	572342	ADB3746
29141	ACV059	571419	ADB1235	571931	ADB0485	572361	ADB0276
29142	ACV060	571422	ADB1437	571932	ADB01021	572363	ADB0297
29143	ACV054	571436	ADB0467	571934	ADB0186	572367	ADB0459
29146	ACV049	571438	ADB3232	571937	ADB0162	572370	ADB3234
29147	ACV053	571439	ADB11055	571941	ADB3945	572373	ADB3863
29149	ACV056	571439	ADB1401	571946	ADB0480	572374	ADB1183
29150	ACV057	571440	ADB1224	571947	ADB0888	572378	ADB0440
29165	ACV061	571442	ADB1319	571948	ADB0953	572382	ADB0447
29167	ACV063	571444	ADB11059	571949	ADB0479	572397	ADB3330
29171	ACV062	571446	ADB11051	571950	ADB0914	572409	ADB3457
29302	ACV004	571447	ADB11054	571964	ADB3393	572442	ADB3481
29498	ACV012	571448	ADB0228	571966	ADB0892	572451	ADB3831
29747	ACV006	571449	ADB1228	571968	ADB3584	572452	ADB0832
29835	ACV002	571454	ADB1204	571969	ADB0989		
571204	ADB0389	571458	ADB0925	571972	ADB0479		
571206	ADB1205	571460	ADB01073	571974	ADB0201		
571213	ADB0731	571463	ADB0112	571975	ADB3583		
571215	ADB0128	571464	ADB0129	571976	ADB3232	LP0015	ADB0389
571221	ADB0101	571509	ADB1570	572101	ADB0122	LP0018	ADB0731
						<b>DELPHI/ LOCKHEED</b>	<b>ALLIED NIPPON</b>



# Interchange Reference

**ANL  
Braking**

DELPHI/ LOCKHEED	ALLIED NIPPON	DELPHI/ LOCKHEED	ALLIED NIPPON	DELPHI/ LOCKHEED	ALLIED NIPPON	DELPHI/ LOCKHEED	ALLIED NIPPON
LP0020	ADB0128	LP0530	ADB3168	LP0870	ADB3320	LP1409	ADB0989
LP0029	ADB0243	LP0536	ADB1515	LP0871	ADB3234	LP1417	ADB3887
LP0030	ADB0112	LP0538	ADB0297	LP0877	ADB2219	LP1418	ADB3924
LP0041	ADB0319	LP0543	ADB3863	LP0878	ADB1275	LP1425	ADB0480
LP0045	ADB0239	LP0548	ADB0124	LP0885	ADB1431	LP1429	ADB0928
LP0056	ADB4311	LP0566	ADB1142	LP0909	ADB11001	LP1430	ADB0734
LP0061	ADB0247	LP0578	ADB0770	LP0911	ADB3232	LP1431	ADB0952
LP0065	ADB0122	LP0580	ADB11054	LP0913	ADB0162	LP1434	ADB3481
LP0071	ADB0313	LP0581	ADB0135	LP0914	ADB01093	LP1437	ADB0914
LP0074	ADB0111	LP0583	ADB11051	LP0918	ADB0419	LP1438	ADB0832
LP0076	ADB0101	LP0584	ADB1235	LP0941	ADB3746	LP1442	ADB31113
LP0078	ADB0171	LP0591	ADB0502	LP0944	ADB3439	LP1444	ADB0142
LP0087	ADB0312	LP0599	ADB11055	LP0950	ADB0440	LP1450	ADB0232
LP0099	ADB4311	LP0604	ADB1228	LP0951	ADB31090	LP1455	ADB0874
LP0106	ADB1205	LP0619	ADB3232	LP0952	ADB3330	LP1469	ADB0891
LP0108	ADB1308	LP0629	ADB3322	LP0954	ADB3233	LP1470	ADB0899
LP0110	ADB0567	LP0630	ADB3285	LP0962	ADB3170	LP1471	ADB0888
LP0154	ADB0156	LP0633	ADB3295	LP0963	ADB0404	LP1474	ADB01018
LP0199	ADB0264	LP0634	ADB3400	LP0967	ADB3587	LP1519	ADB2485
LP0204	ADB0118	LP0651	ADB1413	LP0970	ADB11069	LP1529	ADB11168
LP0208	ADB0130	LP0653	ADB0467	LP0980	ADB0212	LP1535	ADB1953
LP0211	ADB0224	LP0656	ACV005	LP0981	ADB01086	LP1541	ADB11151
LP0213	ADB1412	LP0660	ACV001	LP0989	ADB0459	LP1542	ADB1419
LP0219	ADB0368	LP0661	ACV004	LP0998	ACV016	LP1549	ADB0201
LP0220	ADB3399	LP0662	ACV002	LP0999	ACV017	LP1582	ADB31108
LP0221	ADB0147	LP0668	ADB01073	LP1010	ADB3269	LP1583	ADB31107
LP0230	ADB0391	LP0673	ADB0393	LP1019	ADB0272	LP1585	ADB1479
LP0248	ADB1133	LP0676	ADB3518	LP1027	ADB1142	LP1591	ADB0706
LP0254	ADB1396	LP0677	ADB0228	LP1028	ACV006	LP1592	ADB2714
LP0261	ADB0207	LP0684	ADB3273	LP1029	ACV008	LP1593	ADB3945
LP0350	ADB2310	LP0687	ADB3368	LP1032	ACV013	LP1595	ADB0453
LP0351	ADB0397	LP0696	ADB2416	LP1033	ACV023	LP1596	ADB0478
LP0353	ADB4129	LP0702	ADB0134	LP1034	ACV018	LP1597	ADB0570
LP0358	ADB0177	LP0707	ADB3387	LP1036	ACV022	LP1599	ADB3225
LP0373	ADB0276	LP0726	ADB0423	LP1039	ACV041	LP1601	ADB0707
LP0378	ADB1254	LP0730	ADB1401	LP1039	ACV041	LP1603	ADB0876
LP0400	ADB0323	LP0732	ADB1204	LP1039	ACV042	LP1604	ADB0444
LP0409	ADB3422	LP0735	ADB01089	LP1040	ACV027	LP1607	ADB1174
LP0413	ADB01066	LP0739	ADB0589	LP1041	ACV028	LP1610	ADB0485
LP0415	ADB0135	LP0744	ADB3207	LP1042	ACV029	LP1616	ADB0931
LP0421	ADB0149	LP0756	ADB0149	LP1043	ADB1455	LP1624	ADB0892
LP0427	ADB0125	LP0766	ADB0132	LP1046	ADB0271	LP1625	ADB31014
LP0435	ADB1392	LP0767	ADB0924	LP1047	ACV014	LP1652	ADB0873
LP0436	ADB1204	LP0770	ADB0152	LP1048	ACV007	LP1664	ADB3721
LP0448	ADB0265	LP0777	ADB01078	LP1050	ACV015	LP1673	ADB3584
LP0459	ADB4137	LP0778	ADB0511	LP1053	ADB0258	LP1676	ADB31112
LP0468	ADB0238	LP0785	ADB0925	LP1064	ADB3457	LP1695	ADB01127
LP0472	ADB1319	LP0793	ADB1570	LP1092	ADB0186	LP1707	ADB1852
LP0475	ADB1224	LP0811	ADB0552	LP1096	ADB1183	LP1724	ADB01150
LP0476	ADB0306	LP0817	ADB3402	LP1098	ADB0183	LP1733	ADB11151
LP0480	ADB11059	LP0819	ADB3451	LP1105	ADB1991	LP1745	ADB0874
LP0481	ADB0401	LP0823	ADB1926	LP1139	ADB3393	LP1746	ADB01035
LP0488	ADB0390	LP0828	ADB0991	LP1146	ADB0758	LP1747	ADB01036
LP0490	ADB2258	LP0833	ADB11068	LP1206	ADB0953	LP1748	ADB11031
LP0491	ADB2533	LP0838	ADB0431	LP1210	ADB0256	LP1749	ADB11032
LP0493	ADB1191	LP0847	ADB0447	LP1307	ADB3750	LP1750	ADB11040
LP0501	ADB11047	LP0854	ADB3333	LP1308	ADB3831	LP1751	ADB11041
LP0504	ADB21048	LP0857	ACV003	LP1309	ADB3583	LP1775	ADB11030
LP0506	ADB01052	LP0858	ACV021	LP1385	ADB0479	LP1776	ADB11029
LP0509	ADB0129	LP0859	ACV011	LP1398	ADB3813	LP1790	ADB01042
LP0527	ADB0195	LP0861	ACV009	LP1405	ADB3333	LP1796	ADB0201
LP0529	ADB0316	LP0863	ADB1437	LP1406	ADB01021	LP8040	ACV020



# Interchange Reference

**ANL  
Braking**

DELPHI/ LOCKHEED	ALLIED NIPPON	DON/ MINTEX	ALLIED NIPPON	DON/ MINTEX	ALLIED NIPPON	DON/ MINTEX	ALLIED NIPPON
LP8053	ACV010	CVP074	ADB1183	MDB1329	ADB0316	MDB1657	ADB0447
		CVP075	ADB0183	MDB1331	ADB2533	MDB1659	ADB3232
		CVP080	ACV056	MDB1333	ADB21048	MDB1662	ADB1570
		CVP081	ACV057	MDB1334	ADB0297	MDB1682	ADB0419
		CVP082	ACV036	MDB1340	ADB11051	MDB1690	ADB3587
CVP001	ACV004	CVP082	ACV037	MDB1341	ADB0390	MDB1695	ADB3170
CVP002	ACV002	CVP083	ACV041	MDB1346	ADB0168	MDB1696	ADB0404
CVP003	ACV001	CVP083	ACV041	MDB1362	ADB0124	MDB1699	ADB11059
CVP005	ACV022	CVP086	ACV059	MDB1367	ADB1235	MDB1701	ADB0162
CVP006	ACV009	CVP087	ACV060	MDB1372	ADB0423	MDB1702	ADB11001
CVP007	ACV007	CVP088	ACV058	MDB1380	ADB3368	MDB1703	ADB2219
CVP008	ACV010	CVP090	ACV048	MDB1381	ADB3207	MDB1704	ADB1275
CVP009	ACV015	CVP338	ACV006	MDB1384	ADB1142	MDB1721	ADB0183
CVP010	ACV018	MDB1002	ADB0731	MDB1398	ADB0459	MDB1723	ADB0389
CVP011	ACV008	MDB1003	ADB0128	MDB1404	ADB0502	MDB1729	ADB1991
CVP012	ACV013	MDB1005	ADB0247	MDB1419	ADB0467	MDB1730	ADB11068
CVP013	ACV014	MDB1008	ADB0243	MDB1421	ADB3322	MDB1733	ADB1479
CVP014	ACV016	MDB1013	ADB0112	MDB1422	ADB3320	MDB1737	ADB0453
CVP015	ACV017	MDB1027	ADB4311	MDB1429	ADB0770	MDB1738	ADB0478
CVP016	ACV021	MDB1054	ADB0171	MDB1430	ADB1228	MDB1739	ADB0212
CVP017	ACV020	MDB1068	ADB0731	MDB1439	ADB3168	MDB1744	ADB0272
CVP018	ACV030	MDB1069	ADB0111	MDB1440	ADB3285	MDB1755	ADB01093
CVP019	ACV011	MDB1081	ADB0101	MDB1446	ADB3295	MDB1761	ADB0734
CVP020	ACV041	MDB1099	ADB0312	MDB1449	ADB01086	MDB1762	ADB3225
CVP021	ACV025	MDB1107	ADB0122	MDB1464	ADB3273	MDB1785	ADB31014
CVP022	ACV027	MDB1108	ADB1308	MDB1465	ADB0589	MDB1802	ADB0271
CVP023	ACV029	MDB1110	ADB0567	MDB1471	ADB0991	MDB1804	ADB0706
CVP024	ACV047	MDB1114	ADB0125	MDB1474	ADB3518	MDB1805	ADB0707
CVP025	ACV032	MDB1138	ADB0316	MDB1482	ADB3863	MDB1807	ADB0258
CVP026	ADB0931	MDB1139	ADB0265	MDB1486	ADB0552	MDB1808	ADB0570
CVP027	ACV003	MDB1141	ADB0135	MDB1490	ADB1183	MDB1812	ADB1174
CVP031	ACV028	MDB1144	ADB0264	MDB1493	ADB0393	MDB1814	ADB0186
CVP032	ACV039	MDB1151	ADB4311	MDB1508	ADB3402	MDB1815	ADB2714
CVP033	ACV040	MDB1162	ADB0391	MDB1513	ADB0228	MDB1822	ADB0953
CVP035	ACV038	MDB1166	ADB3399	MDB1514	ADB31090	MDB1823	ADB3269
CVP036	ACV037	MDB1175	ADB0118	MDB1519	ADB2416	MDB1831	ADB3945
CVP037	ACV055	MDB1180	ADB0147	MDB1524	ADB11054	MDB1837	ADB0485
CVP038	ACV050	MDB1183	ADB0368	MDB1528	ADB1204	MDB1842	ADB3393
CVP039	ACV051	MDB1184	ADB0130	MDB1535	ADB0440	MDB1855	ADB1455
CVP040	ADB0319	MDB1192	ADB1205	MDB1537	ADB01073	MDB1862	ADB3457
CVP041	ADB0239	MDB1204	ADB0276	MDB1539	ADB3234	MDB1868	ADB0989
CVP047	ADB1254	MDB1205	ADB1254	MDB1545	ADB3746	MDB1883	ADB0444
CVP048	ADB01066	MDB1207	ADB0207	MDB1556	ADB0134	MDB1884	ADB0876
CVP049	ADB0238	MDB1209	ADB2310	MDB1558	ADB0132	MDB1903	ADB3481
CVP050	ADB11059	MDB1214	ADB1133	MDB1559	ADB0924	MDB1904	ADB3750
CVP051	ADB1412	MDB1218	ADB4129	MDB1561	ADB11069	MDB1905	ADB0832
CVP052	ADB0390	MDB1224	ADB1396	MDB1563	ADB0925	MDB1906	ADB3831
CVP053	ADB11047	MDB1225	ADB0397	MDB1570	ADB0152	MDB1907	ADB3583
CVP054	ADB21048	MDB1235	ADB0128	MDB1571	ADB0511	MDB1908	ADB3584
CVP057	ADB11051	MDB1240	ADB4137	MDB1577	ADB3285	MDB1913	ADB0928
CVP061	ADB01089	MDB1267	ADB0149	MDB1585	ADB0238	MDB1923	ADB3721
CVP062	ADB0132	MDB1267	ADB0149	MDB1590	ADB3330	MDB1927	ADB0256
CVP063	ADB0924	MDB1279	ADB0177	MDB1591	ADB3451	MDB1931	ADB0733
CVP064	ADB0991	MDB1280	ADB3387	MDB1592	ADB3439	MDB1952	ADB0874
CVP065	ADB11054	MDB1291	ADB2258	MDB1606	ADB0142	MDB1953	ADB1874
CVP066	ADB1437	MDB1297	ADB3422	MDB1611	ADB1926	MDB1954	ADB11168
CVP067	ADB2219	MDB1300	ADB1515	MDB1628	ADB1431	MDB1956	ADB0479
CVP068	ADB1275	MDB1307	ADB11047	MDB1644	ADB1437	MDB1961	ADB1142
CVP069	ADB0125	MDB1310	ADB0306	MDB1645	ADB01078	MDB1967	ADB0480
CVP070	ADB0212	MDB1318	ADB0195	MDB1646	ADB3233	MDB1972	ADB0232
CVP071	ADB0453	MDB1327	ADB1191	MDB1647	ADB3333	MDB1987	ADB31113
CVP073	ADB0271	MDB1328	ADB0323	MDB1649	ADB01089	MDB1993	ADB01021



# Interchange Reference

## ANL Braking

DON/ MINTEX	ALLIED NIPPON	EFI	ALLIED NIPPON	EFI	ALLIED NIPPON	EFI	ALLIED NIPPON
MDB1995	ADB3813	EDB1021	ADB0404	EDB1352	ADB11029	EDB471	ADB1224
MDB1997	ADB0914	EDB1038	ADB0212	EDB1353	ADB11030	EDB492	ADB11051
MDB2000	ADB3887	EDB1039	ADB0453	EDB1396	ADB11031	EDB493	ADB01052
MDB2001	ADB3924	EDB1040	ADB1479	EDB1397	ADB11032	EDB501	ACV002
MDB2002	ADB0888	EDB1042	ACV027	EDB1405	ADB01034	EDB503	ACV003
MDB2021	ADB0952	EDB1043	ADB0271	EDB142	ADB1308	EDB509	ADB1228
MDB2025	ADB0758	EDB1044	ADB1455	EDB1422	ADB3269	EDB511	ADB11054
MDB2026	ADB0931	EDB1045	ADB0478	EDB143	ADB0125	EDB516	ADB1235
MDB2028	ADB01087	EDB1046	ACV028	EDB1452	ADB01035	EDB517	ADB0124
MDB2049	ADB11029	EDB1047	ACV029	EDB1453	ADB01036	EDB518	ADB0589
MDB2055	ADB2485	EDB105	ADB0101	EDB1478	ADB11040	EDB519	ADB0228
MDB2059	ADB0899	EDB1054	ADB0706	EDB1479	ADB11041	EDB520	ADB0401
MDB2060	ADB0891	EDB1081	ADB0444	EDB1480	ADB01042	EDB520DWL	ADB11055
MDB2061	ADB31108	EDB1082	ADB0876	EDB149	ADB0567	EDB520WL	ADB1401
MDB2067	ADB0892	EDB1086	ACV030	EDB167	ADB0156	EDB523	ACV004
MDB2073	ADB31112	EDB1095	ADB3945	EDB169	ADB0171	EDB524	ADB1142
MDB2076	ADB0201	EDB11	ADB0128	EDB170	ADB0316	EDB532	ADB0323
MDB2078	ADB31107	EDB1101	ADB0707	EDB173	ADB0135	EDB543	ADB11059
MDB2095	ADB1953	EDB1102	ADB0931	EDB186	ADB0264	EDB547	ADB0168
MDB2096	ADB11151	EDB1112	ADB1174	EDB2	ADB0731	EDB549	ADB0770
MDB2104	ADB1852	EDB1112NWL	ADB0892	EDB206	ADB0118	EDB556	ADB3295
MDB2129	ADB0731	EDB1126	ACV032	EDB208	ADB0130	EDB575	ACV005
MDB2151	ADB1401	EDB1129	ADB31014	EDB215	ADB0391	EDB579/1	ADB0201
MDB2152	ADB0873	EDB113	ADB4311	EDB219	ADB3399	EDB588	ADB3518
MDB2156	ADB11030	EDB1131	ADB0953	EDB22	ADB0243	EDB589	ADB0502
MDB2157	ADB11031	EDB1131WL	ADB1953	EDB225	ADB0368	EDB594	ACV006
MDB2158	ADB11032	EDB1132	ADB0272	EDB239	ADB0238	EDB603	ADB0467
MDB2159	ADB01127	EDB1132/2	ADB0874	EDB243	ADB0147	EDB610	ADB0928
MDB2177	ADB1419	EDB1132/2WL	ADB1874	EDB270	ADB1133	EDB613	ADB3232
MDB2184	ADB3439	EDB1135	ADB0485	EDB274	ADB1396	EDB617	ADB0393
MDB2192	ADB0431	EDB1135WL	ADB2485	EDB287	ADB1254	EDB620	ACV007
MDB2203	ADB3333	EDB1136	ACV033	EDB288	ADB0265	EDB624/8	ACV008
MDB2206	ADB01018	EDB1159	ACV034	EDB29	ADB0112	EDB627	ADB0183
MDB2268	ADB01035	EDB116	ADB0312	EDB293	ADB0207	EDB627WL	ADB1183
MDB2269	ADB01036	EDB1160	ADB0479	EDB306	ADB3422	EDB633	ADB3320
MDB2272	ADB01150	EDB1160/1	ADB01018	EDB318	ADB0297	EDB641	ADB0423
MDB2328	ADB11040	EDB1163	ADB0186	EDB326	ADB3400	EDB643	ADB0276
MDB2329	ADB11041	EDB1163WL	ADB1852	EDB340	ADB0177	EDB655	ADB1437
MGB533	ADB0389	EDB1275	ACV036	EDB346	ADB4129	EDB656	ADB1319
MGB633	ADB0156	EDB1275/1	ACV037	EDB351	ADB0129	EDB668	ACV009
MLB105	ADB1224	EDB1276	ADB3393	EDB364	ADB1204	EDB678	ADB3322
MLB114	ADB01052	EDB1277	ACV038	EDB365	ADB0397	EDB687	ADB1926
MLB115	ADB0401	EDB1279	ACV039	EDB370	ADB4137	EDB690	ADB01066
MLB116	ADB1401	EDB1279/1	ACV040	EDB376	ACV001	EDB700	ADB132
MLB40	ADB0239	EDB1291	ADB0232	EDB377	ADB11047	EDB701	ADB0924
MLB41	ADB0319	EDB1292	ADB01021	EDB39	ADB0122	EDB702	ACV010
MLB43	ADB0224	EDB1293	ADB3584	EDB393	ADB2258	EDB703	ADB0393
MLB65	ADB1392	EDB1294	ADB3750	EDB393NWL	ADB0258	EDB709	ADB11068
MLB69	ADB01066	EDB1295	ADB3583	EDB396	ADB0195	EDB712	ADB3273
MLB76	ADB1412	EDB1304	ADB0480	EDB40	ADB0313	EDB713	ADB11069
MLB79	ADB1319	EDB1305	ADB0888	EDB405	ADB3387	EDB717	ADB3368
MLB81	ADB1392	EDB1306	ADB0914	EDB414	ADB21048	EDB719	ADB2416
MLB85	ADB1413	EDB1312	ADB0989	EDB418	ADB0306	EDB722	ADB0925
		EDB1314	ACV041	EDB419	ADB0149	EDB732	ADB0134
		EDB1315	ADB0909	EDB419AK	ADB0149	EDB733	ACV011
		EDB1328	ACV042	EDB42	ADB1205	EDB738/8	ACV012
		EDB1329	ACV043	EDB428	ADB2310	EDB753	ACV013
		EDB1329/1	ACV044	EDB434	ADB1191	EDB757	ADB3168
EDB1000	ADB11001	EDB1338	ADB3887	EDB440	ADB2533	EDB760	ACV014
EDB1002	ADB2714	EDB1339	ADB3924	EDB450	ADB0390	EDB765	ADB3234
EDB1009	ADB3457	EDB1350	ACV045	EDB455	ADB1515	EDB769	ACV015
EDB1014	ADB3225	EDB1351	ADB11028	EDB455NWL	ADB0515	EDB770	ACV016
EDB1020	ADB3587						
<b>EFI</b>	<b>ALLIED NIPPON</b>						





# Interchange Reference

## ANL Braking

EFI	ALLIED NIPPON	EFI	ALLIED NIPPON	FERODO	ALLIED NIPPON	FERODO	ALLIED NIPPON
EDB773	ACV017	EDP1463	ADB01157	FCV1387	ACV051	FDB1276	ADB3393
EDB774	ADB0152	EDP1476	ADB31161	FCV1388	ACV055	FDB1291	ADB0232
EDB775	ADB0511	EFC102	ADB3812	FCV1389	ACV048	FDB1292	ADB01021
EDB785	ADB01073	EFC109	ACV047	FCV1404	ACV058	FDB1293	ADB3584
EDB791	ADB0991	EFC110	ADB01088	FCV1406	ACV048	FDB1294	ADB3750
EDB791WL	ADB1991	EFC111	ADB01087	FCV239	ADB0238	FDB1295	ADB3583
EDB797	ADB3333	EFC113	ACV048	FCV376	ACV001	FDB1304	ADB0480
EDB801/8	ACV018	EFC114	ACV049	FCV492	ADB11051	FDB1305	ADB0888
EDB804	ADB3233	EFC115	ACV050	FCV501	ACV002	FDB1306	ADB0914
EDB809	ADB0389	EFC116	ACV051	FCV503	ACV003	FDB1312	ADB0989
EDB829	ADB0319	EFC119	ACV053	FCV516	ADB1235	FDB1338	ADB3887
EDB833	ADB0239	EFC120	ACV054	FCV523	ACV004	FDB1339	ADB3924
EDB836	ADB01066	EFC121	ACV055	FCV575	ACV005	FDB1376	ADB0201
EDB839	ADB1412	EFC122	ACV056	FCV594	ACV006	FDB1381	ADB31108
EDB84	ADB0247	EFC123	ACV057	FCV624	ACV008	FDB1384	ADB3813
EDB841	ADB1413	EFC124	ACV058	FCV627	ADB0183	FDB1393	ADB0899
EDB842	ADB1392	EFC125	ADB3919	FCV668	ACV009	FDB1394	ADB0891
EDB844	ADB0224	EFC126	ADB3918	FCV702	ACV010	FDB1396	ADB11031
EDB845	ADB1431	EFC129	ACV059	FCV709	ADB11068	FDB1397	ADB11032
EDB845NWL	ADB0431	EFC130	ACV060	FCV711	ACV015	FDB142	ADB1308
EDB85	ADB0111	EFC131	ACV061	FCV733	ACV011	FDB1422	ADB3269
EDB852	ACV020	EFC132	ACV062	FCV753	ACV013	FDB143	ADB0125
EDB872	ADB01078	EFC133	ACV063	FCV760	ACV014	FDB1452	ADB01035
EDB876	ADB1570	EFI162	OTR162	FCV760	ACV030	FDB1453	ADB01036
EDB876NWL	ADB0570	EHP7057	ADB0734	FCV769	ACV015	FDB1461	ADB31107
EDB879	ACV021	EHP7068	ADB3721	FCV770	ACV016	FDB1477	ADB0892
EDB902	ADB3285	EHP7108	ADB0832	FCV773	ACV017	FDB1478	ADB11040
EDB909	ADB0447	EHP7109	ADB3831	FCV791	ADB0991	FDB1479	ADB11041
EDB918	ADB3402	EHP7130	ADB11168	FCV792	ADB1991	FDB1480	ADB01042
EDB919	ADB3451	EHP7142	ADB3813	FCV801	ACV018	FDB149	ADB0567
EDB930	ADB3746	ELD1027	ADB1142	FCV852	ACV020	FDB1515	ADB01127
EDB933	ADB01086	ELD1055	ADB0758	FCV879	ACV021	FDB167	ADB0156
EDB935	ADB0552	ELD1209	ADB0142	FCV952	ACV022	FDB169	ADB0171
EDB938	ADB3439	ELD543	ADB3863	FCV960	ACV023	FDB170	ADB0316
EDB940	ADB3330	ELD732	ADB1204	FCV987	ACV025	FDB173	ADB0135
EDB941	ADB01089	ELD744	ADB3207	FCV988	ACV041	FDB186	ADB0264
EDB942	ADB31090	ELD962	ADB3170	FDB1000	ADB11001	FDB2	ADB0731
EDB949	ADB0440	ELD989	ADB0459	FDB1002	ADB2714	FDB206	ADB0118
EDB952	ACV022			FDB1009	ADB3457	FDB208	ADB0130
EDB960/8	ACV023			FDB1014	ADB3225	FDB215	ADB0391
EDB967	ADB2219	<b>FERODO</b>	<b>ALLIED NIPPON</b>	FDB1014	ADB3587	FDB219	ADB3399
EDB968	ADB1275			FDB1021	ADB0404	FDB22	ADB0243
EDB970	ADB0419	FCV1042	ACV027	FDB1038	ADB0212	FDB225	ADB0368
EDB970WL	ADB1419	FCV1043	ADB0271	FDB1039	ADB0453	FDB243	ADB0147
EDB980	ADB0162	FCV1046	ACV028	FDB1040	ADB1479	FDB270	ADB1133
EDB981	ADB01093	FCV1047	ACV029	FDB1045	ADB0478	FDB274	ADB1396
EDB987	ACV025	FCV1102	ADB0931	FDB105	ADB0101	FDB287	ADB1254
EDB988	ACV041	FCV1126	ACV032	FDB1054	ADB0706	FDB288	ADB0265
EDB991	ADB0256	FCV1136	ACV033	FDB1081	ADB0444	FDB29	ADB0112
EDP1189	ADB0733	FCV1159	ACV034	FDB1082	ADB0876	FDB293	ADB0207
EDP1281	ADB3481	FCV1275	ACV036	FDB1095	ADB3945	FDB306	ADB3422
EDP1297	ADB31108	FCV1275	ACV037	FDB11	ADB0128	FDB318	ADB0297
EDP1300	ADB0899	FCV1275	ACV043	FDB1101	ADB0707	FDB326	ADB3400
EDP1320	ADB0891	FCV1275	ACV044	FDB1112	ADB1174	FDB340	ADB0177
EDP1341	ADB31112	FCV1277	ACV038	FDB1129	ADB31014	FDB346	ADB4129
EDP1344	ADB31113	FCV1279	ACV039	FDB1131	ADB0953	FDB351	ADB0129
EDP1352	ADB0873	FCV1313	ACV041	FDB1132	ADB0272	FDB364	ADB1204
EDP1367	ADB31107	FCV1314	ACV047	FDB1135	ADB0485	FDB365	ADB0397
EDP1393	ADB01127	FCV1328	ACV042	FDB116	ADB0312	FDB370	ADB4137
EDP1444	ADB01150	FCV1366	ACV049	FDB1160	ADB01018	FDB377	ADB11047
EDP1445	ADB11151	FCV1367	ACV054	FDB1163	ADB0186	FDB39	ADB0122
EDP1448	ADB01153	FCV1386	ACV050	FDB1168	ADB0570	FDB393	ADB2258



# Interchange Reference

## ANL Braking

FERODO	ALLIED NIPPON	FERODO	ALLIED NIPPON	ICER	ALLIED NIPPON	ICER	ALLIED NIPPON
FDB396	ADB0195	FDB829	ADB0319	140690	ADB3168	150894	ACV007
FDB40	ADB0313	FDB830	ADB0224	140701	ADB3295	150903	ACV021
FDB414	ADB21048	FDB833	ADB0239	140702	ADB1224	150908	ACV006
FDB418	ADB0306	FDB836	ADB01066	140730	ADB11054	151037	ACV022
FDB419	ADB0149	FDB839	ADB1412	140731	ADB11068	151038	ACV013
FDB419	ADB0149	FDB84	ADB0247	140799	ADB01052	151040	ACV014
FDB42	ADB1205	FDB840	ADB1392	140800	ADB0401	151040	ACV030
FDB428	ADB2310	FDB841	ADB1413	140834	ADB0183	151042	ACV016
FDB434	ADB1191	FDB842	ADB1392	140839	ADB1401	151043	ACV017
FDB440	ADB2533	FDB844	ADB0224	140853	ADB3322	151078	ACV011
FDB450	ADB0390	FDB845	ADB1431	140880	ADB01073	151080	ACV021
FDB455	ADB0515	FDB85	ADB0111	140881	ADB01073	151088	ACV025
FDB455	ADB1515	FDB871	ADB01052	140884	ADB0423	151161	ACV032
FDB471	ADB1224	FDB872	ADB01078	140885	ADB3863	151163	ACV029
FDB509	ADB1228	FDB876	ADB1570	140891	ADB11069	151194	ACV042
FDB511	ADB11054	FDB886	ADB0319	140892	ADB1437	151195	ACV041
FDB517	ADB0124	FDB902	ADB3285	140893	ADB01089	151221	ACV027
FDB518	ADB0589	FDB909	ADB0447	140895	ADB0925	151244	ACV028
FDB519	ADB0228	FDB918	ADB3402	140896	ADB0132	151253	ACV039
FDB520	ADB1401	FDB919	ADB3451	140897	ADB0924	151254	ACV036
FDB524	ADB1142	FDB930	ADB3746	140904	ADB1235	151254	ACV037
FDB532	ADB0323	FDB933	ADB01086	140926	ADB0228	151254	ACV043
FDB543	ADB11059	FDB935	ADB0552	140927	ADB1228	151254	ACV044
FDB547	ADB0168	FDB938	ADB3439	140933	ADB0447	160689	ACV006
FDB549	ADB0770	FDB940	ADB3330	140935	ADB11059	160832	ACV018
FDB556	ADB3295	FDB941	ADB01089	140965	ACV020	161039	ACV008
FDB588	ADB3518	FDB942	ADB31090	140979	ADB3234	180011	ADB0247
FDB589	ADB0502	FDB949	ADB0440	140980	ADB3233	180020	ADB0128
FDB603	ADB0467	FDB967	ADB2219	140994	ADB1183	180033	ADB0389
FDB610	ADB0928	FDB968	ADB1275	141002	ADB3273	180052	ADB4311
FDB613	ADB3232	FDB970	ADB0419	141006	ADB31090	180058	ADB0731
FDB617	ADB0393	FDB980	ADB0162	141007	ADB3333	180060	ADB4311
FDB633	ADB3320	FDB981	ADB01093	141010	ADB0440	180067	ADB0243
FDB641	ADB0423	FDB991	ADB0256	141022	ADB3439	180068	ADB0112
FDB643	ADB0276	FVR1044	ADB1455	141026	ADB3170	180087	ADB0389
FDB655	ADB1437			141027	ADB0404	180092	ADB0239
FDB656	ADB1319			141046	ADB11001	180106	ADB0313
FDB678	ADB3322	<b>ICER</b>	<b>ALLIED NIPPON</b>	141049	ADB0419	180120	ADB1205
FDB687	ADB1926			141053	ADB1275	180158	ADB0111
FDB690	ADB01066	140313	ADB0264	141057	ADB3746	180162	ADB0731
FDB700	ADB0132	140315	ADB0391	141102	ADB0453	180166	ADB0171
FDB701	ADB0924	140316	ADB0991	141103	ADB0478	180170	ADB0312
FDB703	ADB0393	140347	ADB0276	141104	ADB0212	180183	ADB0567
FDB704	ADB0731	140352	ADB0265	141111	ADB3225	180197	ADB0125
FDB712	ADB3273	140403	ADB1254	141122	ADB2714	180198	ADB1308
FDB713	ADB11069	140405	ADB0238	141126	ADB0271	180207	ADB0316
FDB717	ADB3368	140503	ADB01066	141166	ADB0186	180221	ADB0101
FDB719	ADB2416	140505	ADB11047	141167	ADB0272	180230	ADB0319
FDB72	ADB4311	140518	ADB3387	141168	ADB0953	180231	ADB0224
FDB722	ADB0925	140521	ADB0306	141170	ADB0459	180255	ADB0156
FDB732	ADB0134	140524	ADB3422	141219	ADB01021	180311	ADB0130
FDB747	ADB0401	140526	ADB0177	141234	ADB3269	180317	ADB0368
FDB757	ADB3168	140542	ADB0390	141241	ADB1455	180324	ADB0147
FDB765	ADB3234	140560	ADB1991	141251	ADB0734	180329	ADB0118
FDB774	ADB0152	140562	ADB0991	150659	ACV009	180348	ADB3399
FDB775	ADB0511	140563	ADB11051	150722	ACV002	180409	ADB0207
FDB785	ADB01073	140604	ADB0323	150738	ACV004	180411	ADB0312
FDB797	ADB3333	140614	ADB0297	150759	ACV003	180413	ADB0928
FDB804	ADB3233	140620	ADB21048	150764	ACV001	180418	ADB4129
FDB808	ADB0276	140636	ADB3320	150782	ACV015	180427	ADB1412
FDB809	ADB0389	140648	ADB0124	150831	ACV010	180451	ADB0397
FDB811	ADB0389	140687	ADB0168	150833	ACV015	180454	ADB0135







# Interchange Reference

## ANL Braking

OE PART NUMBER	ALLIED NIPPON	OE PART NUMBER	ALLIED NIPPON	OE PART NUMBER	ALLIED NIPPON	OE PART NUMBER	ALLIED NIPPON
0446528130	ADB0589	1605586	ADB0135	357698151E	ADB0989	4414021	ADB01127
0446530021	ADB0391	1605713	ADB0312	4077636	ADB31108	4432481	ADB11047
0446535020	ADB31090	1605787	ADB0135	4095132	ADB31107	4434816	ADB0112
0446535160	ADB0264	1605810	ADB0134	4100010G08	ADB0423	4434909	ADB0112
0446535170	ADB0265	1605824	ADB0134	4101031E93	ADB0177	45022SA0660	ADB0130
0446535220	ADB0440	1605825	ADB3322	4106001W26	ADB0177	45022SA0N50	ADB0130
0446560020	ADB3170	1605907	ADB0134	4106004C85	ADB3368	5000295329	ADB0183
0446560040	ADB0265	1605957	ADB3583	4106008N90	ADB0423	5000815574	ADB0183
04465YZZAC	ADB0440	1605959	ADB3584	4106011P26	ADB3387	5001855646	ACV058
0446660030	ADB0832	1605961	ADB3750	4106012A25	ADB0207	5010848607	ACV039
0449112141	ADB0111	1668053	ACV004	4106013A25	ADB0207	5015917	ADB0397
0449126041	ADB0297	171698151E	ADB0101	4106031E25	ADB0368	5015919	ADB0118
0449126110	ADB0459	178479	ADB0118	4106031E93	ADB3387	5015924	ADB0156
0449126250	ADB0440	178479	ADB0118	4106032G91	ADB3863	5018897	ADB0567
0449128080	ADB0589	1902292	ADB11047	4106061A90	ADB3207	5018898	ADB0397
0449128220	ADB3746	1902294	ADB1412	4106067R86	ADB3330	5018981	ADB0928
0449130080	ADB0391	1902301	ADB11054	410609C526	ADB0447	5022397	ADB0239
0449135160	ADB3333	1902469	ADB11069	41060B9526	ADB0171	5022398	ADB0319
0449187501000	ADB0770	1902494	ADB11059	41060C7190	ADB0276	5023486	ADB0390
0449187511000	ADB0770	1903383	ADB1235	41060D11426KE	ADB0368	5025048	ADB0502
0449187601000	ADB0323	1903488	ADB11054	41060M4925	ADB0122	5027604	ADB0393
0449187613000	ADB3439	1906038	ADB1413	41060P6625	ADB0391	5028763	ADB0132
0449187622000	ADB3439	1906039	ADB1437	41060T7893	ADB0276	5028764	ADB0924
0449187725000	ADB3457	1906040	ADB11068	4218573	ADB0112	519601	ACV032
0449260010	ADB0404	1906159	ADB1437	424556	ADB1205	5511070A00	ADB0195
0449260020	ADB0404	1906170	ACV016	424833	ADB1254	5520050FA0	ADB0734
069052941	ADB0183	1906183	ACV020	424861	ADB4311	5520060821	ADB3273
09192157	ADB3583	1906401	ADB0931	424862	ADB2258	5520061880	ADB3518
0980106430	ACV061	1906439	ACV041	424864	ADB4311	5581076A00	ADB31113
0980106440	ACV062	191698151C	ADB0149	425001	ADB0243	5810143A00	ADB3225
0980106450	ACV063	191698151E	ADB0124	425006	ADB1205	581014AA00	ADB3481
1010502	ADB0876	191698151H	ADB0149	425010	ADB4311	5882942	ADB0228
1010503	ADB0444	191698151J	ADB0149	425016	ADB1308	5882985	ADB1228
1015598	ADB0393	1957042	ADB0447	425020	ADB1308	5888154	ADB0129
1015598	ADB0393	1H0698151	ADB0149	425033	ADB2258	5888154	ADB4129
1042668	ADB0444	1H0698151A	ADB0706	425037	ADB0515	5888529	ADB1228
1042687	ADB0876	1HM698151	ADB0989	425037	ADB1515	5888781	ADB1142
1048308	ADB3393	211650081A	ADB0129	425054	ADB1254	5892309	ADB0129
1048310	ADB3393	211650081A	ADB4129	425077	ADB0515	5892309	ADB4129
105142205203	ADB0731	211698151F	ADB0128	425077	ADB1515	5892330	ADB1142
1111857	ADB0899	24070005	ACV039	425082	ADB0515	5983918	ADB4137
1135167	ADB31108	251698151A	ADB0247	425082	ADB1515	5983950	ADB4137
1144288	ADB31107	251698151D	ADB0247	425102	ADB2416	6000008304	ADB2310
115430281	ADB0928	251698151E	ADB0247	425106	ADB1254	6014217720	ADB01089
11906401	ADB0931	251698151F	ADB0124	425116	ADB2219	6150947	ADB0390
1299737	ACV048	26200KA120	ADB0552	425117	ADB2219	6188427	ADB0502
12999667	ACV039	26290KA060	ADB0552	425118	ADB1275	6197738	ADB0132
12999676VT	ACV049	26290TA070	ADB0952	425119	ADB1275	6197739	ADB0924
12999743	ACV039	26296AA050	ADB3863	425134	ADB0570	6314200120	ADB01089
12999748VT	ACV059	2701647	ADB0389	425137	ADB0258	6314200320	ADB01089
1440504	ACV059	2718245	ADB0731	425138	ADB0570	6N0698151	ADB0707
145319	ADB0389	291698151A	ADB0238	425150	ADB2714	6U0698151	ADB0928
1554550	ADB0156	2D0698151	ADB0212	425154	ADB1174	701698151C	ADB01073
1554550	ADB0156	2D0698151A	ADB0271	425155	ADB1174	701698151E	ADB0419
1571569	ADB0239	2D0698451	ADB0478	425169	ADB0485	701698151G	ADB0925
1579806	ADB0567	2D0698451A	ADB0453	425170	ADB0570	701698151G	ADB0953
1605009	ADB3583	3057008000	ACV048	425205	ADB0485	701698451	ADB0272
1605025	ADB3750	30850976	ADB3813	4295800	ADB0306	7018202	ADB0132
1605238	ADB0128	3250077	ADB0168	4333335	ADB0243	7018203	ADB0924
1605300	ADB0312	33456781	ADB3945	4358610	ADB31108	725191075	ADB3399
1605321	ADB0312	357698151A	ADB0152	4379298	ADB0243	725191083	ADB3399
1605536	ADB0135	357698151B	ADB0511	4387361	ADB01150	725193011	ADB3451



# Interchange Reference

## ANL Braking

OE PART NUMBER	ALLIED NIPPON	OE PART NUMBER	ALLIED NIPPON	OE PART NUMBER	ALLIED NIPPON	PAGID	ALLIED NIPPON
725193040	ADB3402	94461155	ADB3322	SE021165081B	ADB1204	T0395	ADB3746
7663711	ADB1412	94483220	ADB3322	SE127165081A	ADB1204	T0398	ADB3269
7701050914	ADB01127	95589273	ADB2310	SFP000010	ADB0873	T0449	ADB0101
7701054771	ADB01127	95615159	ADB1254	SFP100360	ADB0232	T0465	ADB0312
7701170172	ADB2310	95616818	ADB1191	STC1601	ADB01078	T0475	ADB0128
7701200247	ADB4311	95659340	ADB2416	STC1880	ADB0162	T0479	ADB0731
7701201622	ADB11054	95661871	ADB1191	TT0029999	ADB0256	T0481	ADB0731
7701202044	ADB21048	97AG2K021BA	ADB3393	UB3949280	ADB3320	T0510	ADB1392
7701202213	ADB2533	980102920	ACV042	UBY23328Z	ADB3320	T0559	ADB0319
7701202710	ADB2533	9940566	ADB1235	YC152K021AC	ADB31108	T0559	ADB1412
7701202956	ADB21048	9945788	ADB2219	YC152K021BA	ADB31108	T0571	ADB0239
7701203895	ADB0991	9945810	ADB1275	YS612K021AA	ADB0899	T0609	ADB0243
7701203895	ADB1183	9947118	ADB1479			T0616	ADB0112
7701203895	ADB1991	9947629	ADB1479			T0624	ADB4129
7701203919	ADB21048	9947934	ADB0479			T0672	ADB0567
7701204066	ADB1431	9949407	ADB01042			T0697	ADB4311
7701205294	ADB01021	9949516	ADB11040			T0800	ADB0122
7701205513	ADB0485	9949517	ADB11041			T0805	ADB0171
7701205996	ADB2485	A0034201220	ACV038	T0003	ADB3207	T0807	ADB0313
7701206763	ADB01036	A0034202420	ADB0914	T0004	ADB3387	T0809	ADB0111
7701207339	ADB01035	A004209720	ADB0914	T0007	ADB3422	T0835	ADB0316
795121	ADB4137	DBP511115	ADB3234	T0009	ADB3863	T0838	ADB0368
795915	ADB2714	EBD2041	ADB3393	T0013	ADB0770	T0841	ADB0135
7D0698151	ADB0186	GBP258	ADB1392	T0019	ADB3400	T0843	ADB0111
7D0698151A	ADB11168	GBP266	ADB0224	T0023	ADB3285	T0854	ADB0130
7D0698151B	ADB1419	GBP272	ADB01066	T0026	ACV009	T0859	ADB0276
7D0698151C	ADB1953	GBP276	ADB1396	T0032	ADB3518	T0865	ADB0391
7D0698151D	ADB1852	GBP656	ADB1396	T0040	ADB11054	T0882	ADB0265
7D0698451A	ADB0874	GBP90290	ADB1319	T0044	ADB3295	T0885	ADB3399
7D0698451B	ADB1874	GBP90306	ADB1392	T0045	ADB1235	T1003	ADB0397
7D0698451F	ADB11151	GBP90318	ADB0467	T0048	ADB11059	T1022	ADB0502
861698151A	ADB0101	GBP90318	ADB0467	T0062	ADB1319	T1029	ADB1228
86AX2K021BA	ADB0156	GBP90320	ADB0467	T0063	ADB11055	T1030	ADB0228
86FX2K021DA	ADB0118	GBP90325	ADB3232	T0082	ADB01066	T1045	ADB0134
87BX2K021AA	ADB0928	GBP90336	ADB3232	T0087	ACV005	T1075	ADB1570
87FX2K021FA	ADB0397	H00149280A	ADB3285	T0091	ADB1437	T1094	ADB0707
87FX32220MA	ADB0567	HE213328Z	ADB3285	T0092	ACV015	T1097	ADB0706
8971686340	ADB3919	K002625	ACV061	T0093	ACV013	T1111	ADB0212
898249280A	ADB0316	K002626	ACV063	T0221	ADB4137	T1113	ADB0876
89VX2K021AA	ADB0239	K002627	ACV062	T0230	ADB0389	T1124	ADB0478
89VX2K021BA	ADB0319	LBU8432	ADB01066	T0264	ADB1205	T1125	ADB1455
89VX2K021CA	ADB0390	LBU9829	ADB01066	T0290	ADB1254	T1137	ADB0570
8E0698151	ADB0511	MB295690	ADB01086	T0303	ADB0128	T1141	ADB0444
9024210110	ADB0271	MB295886	ADB01086	T0311	ADB0238	T1142	ADB0453
90297410	ADB0312	MB500813	ADB3295	T0317	ADB0207	T1144	ADB3584
90297415	ADB0128	MB578016	ADB0316	T0329	ADB0264	T1145	ADB3583
90297419	ADB0128	MB699453	ADB3234	T0331	ADB0297	T1168	ADB0480
9037770	ADB11051	MC894589	ADB01087	T0335	ADB0323	T1169	ADB0888
9038758	ADB0135	MC894601	ADB01088	T0337	ADB0306	T2006	ADB1191
90422995	ADB0134	MR205256	ADB3269	T0343	ADB0316	T2009	ADB1133
90443902	ADB0135	MR205377	ADB3945	T0347	ACV004	T2017	ADB0515
90485140	ADB0134	MR389549	ADB3234	T0348	ADB0390	T2018	ADB0515
90544001	ADB3583	MR389550	ADB3269	T0350	ADB0195	T2018	ADB1515
90544025	ADB3584	OK70Y3328Z	ADB3168	T0351	ADB0149	T3001	ADB3402
90FX2K021AA	ADB0584	RTC3164	ADB0224	T0353	ADB1142	T3003	ADB3322
9200108	ADB31112	RTC3348	ADB01066	T0354	ACV002	T3007	ADB3273
92AX2K021AA	ADB0393	RTC4518	ADB1413	T0354	ADB0168	T3011	ADB3333
92VB2K021AC	ADB0132	RTC4519	ADB1224	T0363	ADB3399	T3012	ADB0440
92VB2K021BC	ADB0924	RTC5574	ADB01052	T0375	ADB0135	T3019	ADB3233
93172261	ADB31161	RTC5756	ADB0401	T0376	ACV006	T3025	ADB3234
93806190	ADB0319	RTC6781	ADB1401	T0382	ADB11068	T3027	ADB3330
94130145	ADB0306	S08349280	ADB0168	T0383	ADB11051	T3030	ADB3451
		S23149280A	ADB3168	T0389	ADB0132		
				T0390	ADB0924		



# Interchange Reference

**ANL  
Braking**

PAGID	ALLIED NIPPON	PAGID	ALLIED NIPPON	REMSA	ALLIED NIPPON	REMSA	ALLIED NIPPON
T3036	ADB3225	T9057	ADB0271	109 22	ADB3399	238 04	ADB3322
T3037	ADB0447	T9058	ADB0931	109 34	ADB3400	244 00	ADB0168
T3064	ADB0404	T9059	ACV029	111 00	ADB0130	244 02	ADB3168
T3069	ADB3439	T9060	ACV039	115 00	ADB0391	245 00	ACV002
T3076	ADB3170	T9061	ACV040	117 00	ADB0368	245 12	ACV021
T3081	ADB3587	T9063	ACV041	117 02	ADB3368	258 04	ACV009
T3083	ADB0459	T9063	ACV041	119 00	ADB0118	258 14	ACV028
T4017	ADB0118	T9063	ACV042	119 10	ADB0444	264 00	ADB0142
T4023	ADB0156	T9064	ACV011	120 00	ADB0264	264 01	ADB1142
T4099	ADB1308	T9071	ACV028	122 11	ADB1392	264 82	ADB1142
T4113	ADB0147	T9072	ACV025	128 01	ADB1204	266 00	ADB01052
T4114	ADB0731	T9076	ACV027	128 23	ADB1204	267 00	ADB0401
T4116	ADB0247	T9077	ACV008	129 00	ADB0276	267 11	ADB1401
T4135	ADB0125	T9083	ACV036	132 00	ADB0265	275 02	ADB3295
T4154	ADB0149	T9084	ACV037	134 40	ADB0511	277 10	ACV001
T5012	ADB0124	T9084	ACV043	134 50	ADB0152	277 12	ACV003
T5016	ADB1204	T9084	ACV044	141 01	ADB1133	278 00	ACV004
T5018	ADB11047	T9085	ACV033	141 10	ADB0431	278 02	ACV010
T5019	ADB1396	T9086	ACV047	141 16	ADB1431	278 14	ACV011
T5048	ADB01073	T9087	ACV038	142 30	ADB01089	278 22	ACV007
T5050	ADB0152	T9090	ACV023	143 86	ADB1254	278 40	ACV025
T5051	ADB0511	T9091	ACV018	144 24	ADB2310	281 00	ADB0228
T5054	ADB0928	T9092	ACV034	144 32	ADB2533	281 02	ADB1228
T5065	ADB3232			146 60	ADB4137	283 00	ADB1086
T5066	ADB0925			147 22	ADB3518	283 10	ADB1087
T5072	ADB0419	<b>REMSA</b>	<b>ALLIED NIPPON</b>	148 14	ADB3285	285 10	ADB0502
T5073	ADB0467			149 00	ADB0207	285 20	ADB0876
T5074	ADB1926	001 02	ADB1308	149 02	ADB3207	289 02	ADB3273
T5077	ADB1133	002 00	ADB0128	154 00	ADB0928	305 44	ADB11001
T5077	ADB1431	002 20	ADB0247	159 00	ADB01066	306 00	ADB0589
T5078	ADB2219	006 00	ADB0731	168 00	ADB0397	306 22	ADB3746
T5079	ADB1275	010 20	ADB0125	169 01	ADB1396	307 00	ADB0552
T5084	ADB11001	010 40	ADB0147	170 00	ADB0515	315 02	ADB31090
T5089	ADB0272	014 00	ADB0312	170 12	ADB1515	315 04	ADB3333
T5095	ADB0989	017 00	ADB0101	170 14	ADB1191	321 22	ADB1455
T5099	ADB1174	021 06	ADB4311	170 34	ADB1926	327 00	ACV006
T5100	ADB3945	022 00	ADB0112	171 10	ADB0149	331 00	ADB0393
T6028	ADB2310	022 10	ADB0243	171 10	ADB0149	331 04	ADB3393
T6064	ADB2533	039 00	ADB0389	172 10	ADB0201	336 00	ADB0467
T9000	ADB21048	045 32	ADB1205	178 10	ADB0323	337 02	ADB3232
T9003	ADB0129	047 04	ADB11051	178 32	ADB3439	337 10	ADB0232
T9004	ADB0991	047 22	ADB1235	184 00	ADB0177	340 02	ADB3402
T9006	ACV001	047 30	ADB0238	184 02	ADB3387	346 04	ACV015
T9012	ADB0393	047 52	ADB11068	187 02	ADB3422	354 02	ADB3234
T9013	ADB1991	048 00	ADB0991	190 00	ADB0195	363 02	ADB3330
T9014	ADB0183	048 02	ADB1991	192 00	ADB0258	372 00	ADB0129
T9020	ADB1183	048 10	ADB0183	192 12	ADB2258	372 02	ADB4129
T9025	ADB01089	048 12	ADB1183	192 34	ADB2416	383 00	ADB01073
T9028	ADB2416	052 10	ADB0224	197 10	ADB0297	385 00	ADB0925
T9029	ADB2416	056 00	ADB0319	202 02	ADB21048	385 10	ADB0953
T9034	ACV017	056 04	ADB1412	204 00	ADB0306	389 02	ADB3587
T9035	ACV016	056 11	ADB1413	206 00	ADB0390	391 00	ADB0132
T9036	ACV021	056 12	ADB1319	211 04	ADB11047	392 00	ADB0924
T9040	ACV021	058 00	ADB0239	211 12	ADB11054	393 20	ADB0134
T9041	ACV041	063 00	ADB0156	211 22	ADB1437	394 00	ADB3812
T9044	ACV014	067 10	ADB0122	218 02	ADB3320	400 00	ACV023
T9044	ACV030	077 00	ADB0171	222 01	ADB1224	400 02	ACV018
T9048	ACV020	078 00	ADB0313	223 00	ADB0124	405 02	ADB3233
T9051	ADB01078	079 00	ADB0111	224 12	ADB3451	412 20	ADB0440
T9052	ADB1224	091 00	ADB0567	232 00	ADB0770	413 04	ADB0404
T9054	ADB2714	094 30	ADB0316	236 00	ADB0423	421 00	ADB0459
T9055	ACV032	101 20	ADB0135	236 02	ADB3863	429 04	ADB3170





# Interchange Reference

## ANL Braking

REMSA	ALLIED NIPPON	REMSA	ALLIED NIPPON	ROADLINK	ALLIED NIPPON	ROULUNDS	ALLIED NIPPON
435 02	ADB11069	685 22	ADB3750	RCV792	ADB1991	430781	ADB0264
435 12	ADB11029	701 00	ADB0480	RCV801	ACV018	430981	ADB0118
436 02	ACV020	706 00	ADB0832	RCV829	ADB0319	432181	ADB0207
461 02	ADB1570	707 04	ADB3831	RCV833	ADB0239	432481	ADB0393
461 10	ADB0570	708 02	ADB3813	RCV839	ADB1412	433481	ADB4129
462 00	ADB0447	717 00	ADB0888	RCV841	ADB1413	433981	ADB1133
480 00	ADB0419	721 02	ADB11168	RCV852	ACV020	434681	ADB3399
486 02	ADB2219	724 02	ADB31113	RCV879	ACV021	434981	ADB0391
487 02	ADB1275	733 00	ADB0914	RCV952	ACV022	435083	ADB1205
494 00	ADB0225	765 00	ADB0899	RCV960	ACV023	435281	ADB2310
494 02	ADB3225	766 00	ADB0891	RCV987	ACV025	436181	ADB0129
497 00	ACV016	767 12	ADB11151	RCV988	ACV041	436681	ADB0149
498 00	ACV017	772 02	ADB31108	RCV988	ACV042	436681	ADB0149
501 02	ADB3457	772 12	ADB31107			437081	ADB1396
505 04	ACV008	774 02	ADB31112			437381	ADB4137
506 02	ACV014	774 12	ADB31161	<b>ROULUNDS</b>	<b>ALLIED NIPPON</b>	437881	ADB11059
506 02	ACV030	834 00	ADB01127			437881	ADB1319
571 02	ADB31014			423381	ADB3285	437881	ADB1413
576 00	ADB0162			426981	ADB0135	440781	ADB0297
577 00	ADB01093	<b>ROADLINK</b>	<b>ALLIED NIPPON</b>	426987	ADB0135	441581	ADB0177
578 00	ADB0212			429981	ADB0316	441681	ADB0276
579 00	ADB0453	RCV1042	ACV027	433181	ADB0368	442045	ADB0171
580 00	ADB0478	RCV1043	ADB0271	433182	ADB0368	443081	ADB0319
583 00	ADB3269	RCV1046	ACV028	434381	ADB2533	446081	ADB1224
584 00	ADB01078	RCV1047	ACV029	435981	ADB0156	448281	ADB1142
585 04	ACV013	RCV1102	ADB0931	435983	ADB0156	451585	ADB0243
588 01	ADB1479	RCV1126	ACV032	437781	ADB0224	452084	ADB0112
588 10	ADB01018	RCV1275	ACV036	456181	ADB3232	452981	ADB0770
588 20	ADB0479	RCV1277	ACV038	458281	ADB3232	453081	ADB1254
591 00	ADB0272	RCV1279	ACV039	458781	ADB0731	456581	ADB0467
591 10	ADB0874	RCV1329	ACV037	460087	ADB0224	458581	ADB01089
591 12	ADB1874	RCV1329	ACV043	460281	ADB0731	460581	ADB01086
593 00	ADB0734	RCV1329	ACV044	460283	ADB0731	460781	ADB3863
602 02	ADB2714	RCV239	ADB0238	460284	ADB0731	460888	ADB0101
605 02	ADB3945	RCV376	ACV001	460285	ADB0731	462581	ADB3320
606 00	ADB0758	RCV450	ADB0390	460288	ADB0731	462881)1	ADB0168
609 00	ADB0706	RCV492	ADB11051	461584	ADB0389	462881)3	ADB3168
609 10	ADB0707	RCV501	ACV002	461585	ADB0389	463481	ADB0247
614 00	ADB0271	RCV503	ACV003	463281	ADB0128	463781	ADB01073
618 00	ADB0186	RCV511	ADB11054	463283	ADB0128	464685	ADB0111
618 01	ADB1852	RCV516	ADB1235	463284	ADB0128	464781	ADB3333
620 00	ADB0928	RCV523	ACV004	463881	ADB0312	467981	ADB0147
622 00	ACV029	RCV543	ADB11059	463883	ADB0312	470081	ADB0134
623 00	ADB0952	RCV575	ACV005	473287	ADB4311	470281	ADB1191
631 00	ADB0989	RCV594	ACV006	473881	ADB0731	474481	ADB0515
634 00	ADB0892	RCV620	ACV007	497781	ADB0316	474481	ADB1515
634 04	ADB1174	RCV624	ACV008	528281	ADB2533	475881)3	ADB1570
635 00	ADB0256	RCV627	ADB0183	573081	ADB4311	476381	ADB0925
637 00	ACV041	RCV656	ADB1319	654681	ADB3285	478081	ADB3234
637 00	ACV041	RCV668	ACV009	420481	ADB0928	479781	ADB3295
637 00	ACV042	RCV700	ADB0132	421483	ADB0122	482182	ADB3233
640 00	ACV032	RCV701	ADB0924	421881	ADB0397	483781	ADB0132
643 00	ADB0485	RCV702	ACV010	423101	ADB0313	484881	ACV020
643 01	ADB2485	RCV709	ADB11068	423282	ADB0567	486481	ADB0924
651 00	ADB0931	RCV733	ACV011	423501	ADB0239	486681	ADB3322
658 00	ACV039	RCV753	ACV013	423981	ADB1412	487081	ADB0502
661 02	ACV027	RCV760	ACV014	424281	ADB0125	487981	ADB11055
662 02	ADB3721	RCV760	ACV030	426181	ADB0238	487981	ADB1401
677 00	ADB01021	RCV769	ACV015	426281	ADB1308	488481	ADB0152
680 00	ACV033	RCV770	ACV016	427281	ADB1392	488581	ADB0511
683 02	ADB3583	RCV773	ACV017	427481	ADB0130	489481	ADB0459
684 02	ADB3584	RCV791	ADB0991	427781	ADB0124	489781	ADB3387



# Interchange Reference

## ANL Braking

ROULUNDS	ALLIED NIPPON	VALEO	ALLIED NIPPON	WVA	ALLIED NIPPON	WVA	ALLIED NIPPON
491981	ADB1926	540407	ADB0390	20364 15.00	ADB0239	20905 18.00	ADB0258
493981	ADB0440	540421	ADB21048	20392 15.00	ADB0125	20905 18.00	ADB2258
494781	ACV001	540435	ADB1437	20397 14.50	ADB0731	20906 18.00	ADB2416
494881	ACV004	540436	ADB11068	20422 17.50	ADB0567	20923 17.50	ADB1191
495081	ADB11051	540437	ADB1319	20452 19.00	ADB1308	20926 18.50	ADB21048
495181	ACV002	540441	ADB01089	20454 19.00	ADB1308	20928 18.50	ADB21048
495381	ADB1235	540545	ADB11059	20455 19.00	ADB1308	20932 14.00	ADB01089
497481	ADB0265	540546	ADB11054	20465 18.00	ADB11051	20937 18.00	ADB1133
497881	ADB0323	540557	ADB0132	20465 18.00	ADB1235	20939 15.40	ADB0135
498181	ADB11047	540558	ADB0924	20468 15.00	ADB0128	20946 16.50	ADB1204
498381	ADB0390	540731	ADB1235	20476 15.50	ADB0316	20950 18.00	ADB0129
498881	ADB0401	541600	ACV009	20478 18.00	ADB1133	20950 18.00	ADB4129
498981	ADB0306	541604	ACV010	20491 15.00	ADB0156	20958 16.00	ADB0207
499081	ADB01066	541607	ACV008	20494 14.00	ADB4311	20958 16.00	ADB3207
499681	ADB21048	541609	ACV006	20498 20.00	ACV012	20979 19.50	ADB0124
499881	ADB3746	541612	ACV011	20529 14.50	ADB0122	20986 18.00	ADB2258
529481)3	ADB2258	541614	ACV003	20547 16.50	ADB0134	20988 17.50	ADB0515
553781	ADB2416	541615	ACV013	20628 15.00	ADB0391	20988 17.50	ADB1515
620081	ADB3518	541616	ACV016	20630 14.50	ADB0731	20989 17.50	ADB0515
622181	ADB0423	541617	ACV017	20634 15.00	ADB2533	20989 17.50	ADB1191
623481	ADB3422	541641	ACV020	20634 15.00	ADB2533	20989 17.50	ADB1515
623781	ADB3273	541643	ACV001	20635 18.00	ADB2310	21006 18.00	ADB11051
624081	ADB0447	541644	ACV029	20640 18.00	ADB0118	21023 17.50	ADB1191
638381	ADB3225	541645	ACV041	20652 18.00	ADB0925	21048 18.30	ADB11047
640281	ADB3330	541645	ACV041	20653 18.00	ADB11059	21048 18.30	ADB11054
642181	ADB0570	541645	ACV042	20703 14.50	ADB0111	21048 18.30	ADB1437
642681	ADB1174	551032	ADB11047	20706 17.00	ADB0183	21049 18.30	ADB11047
643081	ADB0707	551474	ADB1412	20708 16.50	ADB1204	21061 18.00	ADB2258
643281	ADB0706	551522	ADB0130	20708 16.50	ADB1204	21061 18.00	ADB2416
643881	ADB3587			20710 14.00	ADB4311	21080 17.50	ADB0515
644981	ADB0404			20718 14.50	ADB0368	21080 17.50	ADB1515
646681	ADB3170	<b>WVA</b>	<b>ALLIED NIPPON</b>	20718 14.50	ADB3368	21084 17.50	ADB1396
646881	ADB0272			20729 15.00	ADB0264	21085 17.50	ADB1396
646981	ADB0162	20002 14.50	ADB0168	20731 15.50	ADB0130	21099 17.00	ADB0177
647181	ADB01093	20002 14.50	ADB3168	20736 14.30	ADB0313	21099 17.00	ADB3387
647381	ADB3945	20011 15.00	ADB0128	20741 19.00	ADB1254	21100 17.00	ADB0142
647781	ADB0186	20011 18.50	ADB0247	20753 18.00	ADB0118	21100 17.00	ADB1142
650181	ADB1204	20034 14.50	ADB0731	20753 18.00	ADB0444	21100 17.00	ADB1142
650881	ADB3207	20073 17.50	ADB0112	20754 14.50	ADB1392	21105 17.00	ADB1142
651181	ADB0552	20074 10.00	ADB0243	20755 14.50	ADB0731	21109 15.50	ADB0316
651781	ADB3451	20088 14.00	ADB0389	20766 15.00	ADB3399	21115 16.00	ADB0306
652081	ADB3402	20107 14.50	ADB0731	20767 15.00	ADB3400	21119 17.00	ADB3387
654781	ADB1204	20124 18.00	ADB01073	20772 18.00	ADB1133	21141 18.00	ADB0390
658781	ADB0183	20128 14.50	ADB0122	20775 18.00	ADB0129	21142 15.00	ADB0195
658881	ADB11069	20140 14.00	ADB4311	20775 18.00	ADB4129	21158 15.00	ADB0297
659781	ADB3269	20145 17.50	ADB1205	20776 18.00	ADB0129	21160 18.00	ADB1319
661981	ADB3439	20168 16.00	ADB0152	20776 18.00	ADB4129	21160 18.00	ADB1413
664281	ADB1991	20168 19.30	ADB0511	20780 13.50	ADB0770	21171 17.80	ADB0393
721281	ADB0258	20182 15.50	ADB3422	20783 18.00	ADB0118	21188 18.30	ADB11054
724281)1	ADB0431	20228 15.00	ADB0101	20784 18.00	ADB0238	21193 18.00	ADB0228
724281)3	ADB1431	20289 15.30	ADB0171	20833 17.00	ADB4137	21195 18.00	ADB1228
742581	ADB2714	20313 14.30	ADB0313	20835 22.00	ACV002	21202 17.20	ADB0502
		20323 16.50	ADB0312	20838 17.00	ADB4137	21202 17.20	ADB0876
		20341 17.50	ADB0147	20852 15.00	ADB0265	21224 16.00	ADB3207
<b>VALEO</b>	<b>ALLIED NIPPON</b>	20344 15.00	ADB0224	20854 15.00	ADB3399	21229 17.00	ADB0177
		20344 16.00	ADB1224	20857 17.25	ADB0397	21237 16.00	ADB1224
		20347 14.00	ADB4311	20861 17.50	ADB0928	21243 14.00	ADB0323
541621	ACV021	20359 18.00	ADB0319	20863 16.50	ADB0276	21245 17.50	ADB0256
541622	ACV021	20359 18.00	ADB11059	20887 19.50	ADB0149	21249 15.50	ADB0589
541642	ACV014	20359 18.00	ADB1319	20888 19.50	ADB0149	21302 22.00	ACV011
541649	ACV014	20359 18.00	ADB1412	20892 15.00	ADB3285	21311 16.50	ADB0134
541650	ACV014	20359 18.00	ADB1413	20904 18.00	ADB01066	21318 15.00	ADB3285
541651	ACV014						



# Interchange Reference

## ANL Braking

WVA	ALLIED NIPPON	WVA	ALLIED NIPPON	WVA	ALLIED NIPPON	WVA	ALLIED NIPPON
21333 15.00	ADB3518	21769 15.70	ADB3234	23124 17.50	ADB1174	29059 30.00	ACV041
21334 15.00	ADB3518	21775 15.00	ADB3170	23176 18.00	ADB1953	29060 30.00	ACV041
21347 17.00	ADB0423	21784 15.00	ADB31090	23181 17.50	ADB01018	29065 22.00	ACV021
21348 17.00	ADB3863	21797 19.00	ADB2219	23200 18.00	ADB0899	29067 22.00	ACV011
21353 16.50	ADB0134	21799 19.00	ADB1275	23202 18.00	ADB0891	29071 17.00	ADB0183
21363 15.70	ADB3234	21801 18.00	ADB11001	23205 18.00	ADB0485	29072 19.00	ACV008
21369 15.50	ADB0589	21827 17.00	ADB0570	23205 18.00	ADB2485	29074 20.00	ACV023
21373 16.20	ADB3295	21835 15.50	ADB3746	23224 17.00	ADB0874	29075 20.00	ACV018
21430 17.00	ADB0570	21836 15.50	ADB3746	23224 17.00	ADB1874	29076 19.50	ADB0271
21430 17.00	ADB1570	21837 15.50	ADB3746	23225 17.00	ADB31112	29077 27.00	ACV027
21432 17.00	ADB1570	21840 15.50	ADB3233	23226 17.00	ADB31112	29083 28.00	ACV014
21459 18.00	ADB0401	21842 15.50	ADB3233	23258 17.00	ADB3750	29084 30.00	ACV030
21459 18.00	ADB11055	21861 15.00	ADB3945	23290 17.00	ADB3269	29087 30.00	ACV042
21459 18.00	ADB1401	21866 17.00	ADB0707	23300 18.50	ADB3393	29088 26.00	ACV039
21463 18.00	ADB0431	21866 19.00	ADB0706	23302 18.00	ADB01021	29090 28.00	ACV029
21463 18.00	ADB1431	21882 17.00	ADB0272	23346 17.50	ADB0892	29091 27.00	ACV040
21467 16.50	ADB3322	21883 20.00	ADB0186	23430 18.00	ADB31108	29093 30.00	ACV036
21468 15.50	ADB0459	21884 20.00	ADB0186	23434 18.00	ADB31107	29094 30.00	ACV036
21469 18.00	ADB0924	21885 20.00	ADB0186	23440 17.50	ADB01150	29095 30.00	ACV037
21469 18.00	ADB3924	21885 20.00	ADB1852	23446 16.50	ADB11151	29095 30.00	ACV043
21470 18.00	ADB0132	21897 18.00	ADB11055	23452 18.00	ADB0162	29095 30.00	ACV044
21470 18.00	ADB3887	21904 17.00	ADB1455	23458 15.50	ADB01093	29097 20.50	ACV028
21479 18.30	ADB0419	21907 15.00	ADB3587	23471 14.50	ADB01078	29099 25.00	ACV034
21479 18.30	ADB1419	21930 17.40	ADB0479	23472 17.50	ADB31014	29100 25.00	ACV033
21481 15.50	ADB0447	21930 17.40	ADB1479	23482 16.80	ADB01153	29105 30.00	ACV041
21500 15.00	ADB3273	21931 17.40	ADB0479	23484 17.00	ADB3721	29106 30.00	ACV041
21502 15.00	ADB3273	21931 17.40	ADB1479	23507 15.00	ADB31113	29107 20.00	ACV045
21515 17.50	ADB0232	21932 17.40	ADB0479	23524 17.70	ADB3831	29108 30.00	ACV042
21515 17.50	ADB3232	21932 17.40	ADB1479	23536 15.50	ADB3481	29113 28.00	ACV014
21516 17.50	ADB0232	21945 16.00	ADB0989	23539 17.50	ADB0832	29113 30.00	ACV030
21516 17.50	ADB3232	21947 15.00	ADB0404	23552 18.00	ADB0201	29114 30.00	ACV030
21518 17.00	ADB0467	21952 15.50	ADB3457	23577 18.00	ADB31108	29115 27.00	ACV038
21519 18.00	ADB01052	21967 14.00	ADB3439	23602 19.00	ADB11031	29115 34.00	ACV038
21537 15.00	ADB3285	21978 18.00	ADB0485	23602 19.00	ADB11040	29119 30.00	ACV059
21542 14.00	ADB0552	21978 18.00	ADB2485	23603 19.00	ADB11032	29120 30.00	ACV054
21543 16.50	ADB3322	21980 18.00	ADB0485	23603 19.00	ADB11041	29121 17.00	ADB0909
21544 16.50	ADB3322	21980 18.00	ADB2485	23615 17.50	ADB0873	29121 19.50	ADB0931
21547 14.80	ADB3402	21983 17.30	ADB3813	23616 17.80	ADB01035	29122 22.00	ACV032
21549 14.80	ADB3402	21991 17.00	ADB3750	23669 16.80	ADB01036	29123 20.00	ADB01034
21572 17.00	ADB1455	22038 18.50	ADB11069	29001 20.00	ACV020	29124 27.00	ACV047
21573 14.00	ADB01089	23003 18.30	ADB2714	29011 25.00	ACV017	29125 30.00	ACV055
21576 19.30	ADB0212	23020 18.00	ADB0888	29012 18.00	ADB11068	29126 30.00	ACV048
21592 18.00	ADB0478	23021 18.50	ADB0914	29013 20.50	ACV028	29131 30.00	ACV058
21609 18.00	ADB2416	23022 20.50	ADB0480	29013 21.50	ACV009	29136 30.00	ACV050
21614 17.50	ADB1926	23034 18.50	ADB11168	29017 23.00	ACV001	29137 30.00	ACV051
21621 16.60	ADB0453	23042 18.00	ADB2714	29017 23.00	ACV003	29138 18.00	ADB11028
21627 19.00	ADB2219	23052 17.00	ADB3750	29017 23.00	ACV022	29139 18.00	ADB11029
21629 19.00	ADB1275	23056 19.60	ADB3583	29024 23.00	ACV003	29140 18.00	ADB11030
21634 18.00	ADB0953	23060 19.60	ADB3583	29029 23.00	ACV022	29141 30.00	ACV059
21634 18.00	ADB1953	23063 17.00	ADB3584	29030 28.00	ACV014	29142 30.00	ACV060
21635 18.00	ADB0953	23068 17.00	ADB1142	29032 25.00	ACV016	29143 30.00	ACV054
21635 18.00	ADB1953	23081 19.00	ADB0225	29033 22.00	ACV007	29145 30.00	ACV036
21662 17.50	ADB0928	23081 19.00	ADB3225	29036 24.00	ACV005	29146 30.00	ACV049
21679 15.00	ADB3333	23083 19.00	ADB0225	29037 18.50	ADB11069	29147 30.00	ACV053
21680 15.00	ADB3333	23083 19.00	ADB3225	29039 22.00	ACV010	29149 28.00	ACV056
21689 15.50	ADB0440	23099 18.00	ADB01127	29040 18.00	ADB1235	29150 30.00	ACV057
21709 15.50	ADB3451	23101 17.20	ADB0876	29041 18.30	ADB1437	29154 30.00	ACV049
21711 15.50	ADB3451	23102 17.20	ADB0876	29042 30.00	ACV041	29165 29.00	ACV061
21716 16.00	ADB3330	23103 18.00	ADB0444	29043 24.00	ACV015	29167 29.00	ACV063
21718 16.00	ADB3330	23104 18.00	ADB0444	29044 20.00	ACV013	29171 29.00	ACV062
21748 17.00	ADB0272	23116 19.60	ADB3583	29053 30.00	ACV030	29302 22.00	ACV004
21768 15.70	ADB3234	23124 17.50	ADB0892	29055 22.00	ACV025	29302 22.00	ACV007



# Interchange Reference

## ANL Braking

WVA	ALLIED NIPPON	ALLIED NIPPON	ALLIED NIPPON	ALLIED NIPPON	ALLIED NIPPON	ALLIED NIPPON	ALLIED NIPPON
29357 19.50	ADB0931						
29374 22.00	ACV032						
29498 20.00	ACV012						
29581 15.00	ADB0125						
29706 16.50	ADB0991						
29706 16.60	ADB1991						
29707 17.00	ADB0183						
29747 32.00	ACV006						
29784 18.00	ADB0238						
29835 21.50	ACV002						
29947 16.50	ADB0991						
29947 17.00	ADB0183						
29984 16.50	ADB0991						
29984 16.50	ADB1991						
29985 16.50	ADB1183						
29985 16.50	ADB1183						